



TREKHAKEN • ATTELAGES • ANHÄNGERVORRICHTUNGEN • TOWBARS • ENHANCES • ANHÆNGERTRÆK
Montagehandleiding | instructions de montage | Einbauanleitung | Mounting instruction
Instrucciones de montaje | monteringsvejledning



Renault Captur

'13-

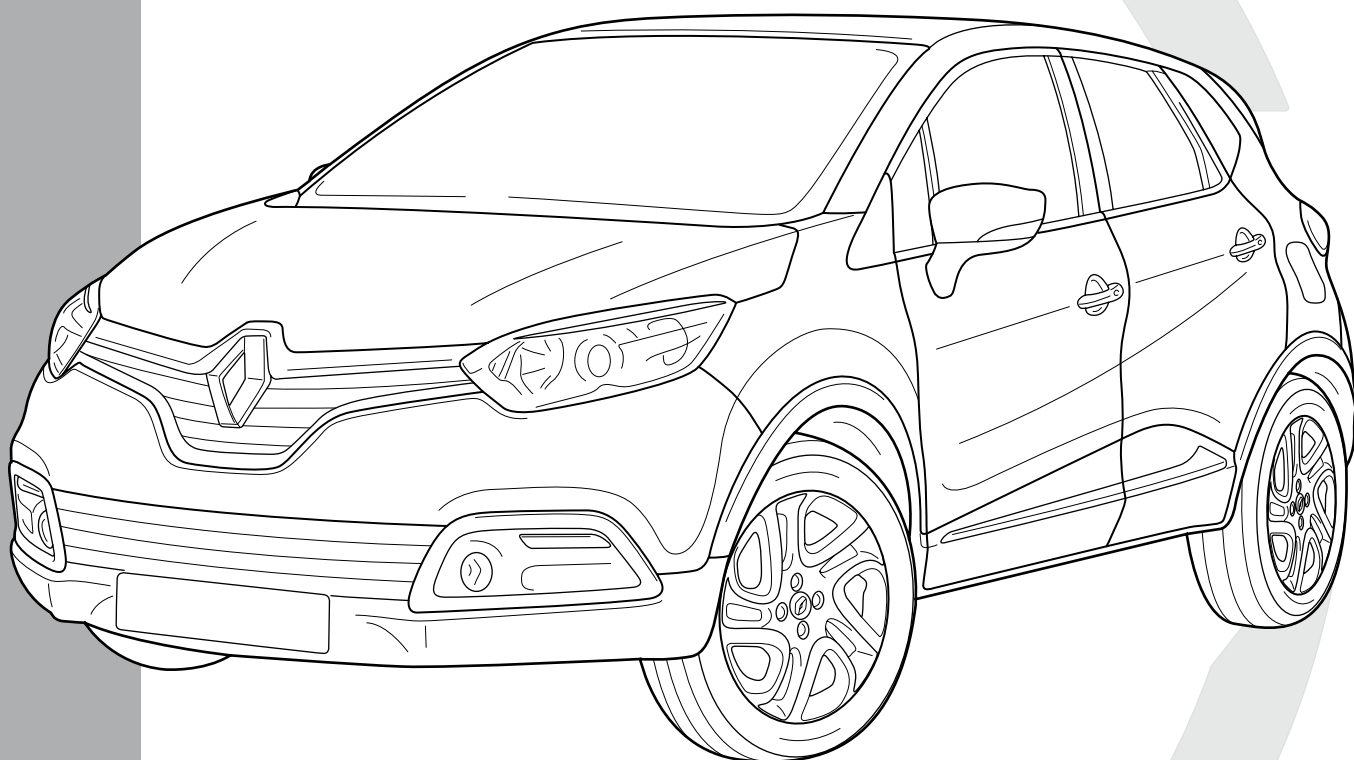

Montage

- Voor aanvang van de montage dient de trekhaak gecontroleerd te worden op transport schade.
- Raadpleeg aandachtig de montagehandleiding. Alle instructies dienen gevolgd te worden.
- Voor de montage moet de trekhaak eerst op het voertuig gepresenteerd worden.
- Bij het boren van gaten, controleren dat aanwezige bekabelingen niet beschadigd kunnen worden. Verwijder antidreun of bitumenlaag. Geboorde gaten en carrosserie onderdelen met corrosiewerende verf behandelen.
- Als het voertuig geen standaard bumpers heeft (speciale serie, sportuitvoeringen, Tuning parts ...), dient de uitsparingsmal gecontroleerd te worden. Neem bij twijfel contact op met GDW.

De geleverde trekhaak is enkel gemonteerd voor stockering, daarom moeten alle onderdelen worden gedemonteerd!

Garantie

- Voor het juiste aanhangergewicht dat uw voertuig mag trekken, controleer het COC van het voertuig of contacteer uw dealer. De specificaties van de trekhaak mogen niet worden overschreden. Zie pagina 5.
- Na 1.000.km gebruik en ten minste 1 keer per jaar hoeft de trekhaak gecontroleerd te worden:
 - * Alle boutverbindingen controleren en bij spannen als nodig.
 - * Beschadiging aan de verf herstellen.
 - * Als de trekhaak door een externe belasting geraakt wordt moet deze vervangen worden.
 - * De interne delen van het afneembaar systeem moeten ingevet worden.

Gebruik

- Indien trekhaak kogel de kentekenplaat of het mistlicht geheel of gedeeltelijk bedekt MOET deze bij niet gebruik verwijderd worden.

Montage

- S'assurer que l'attelage n'ait pas été endommagé durant le transport. Vérifier la référence.
- Consulter attentivement la notice de pose et suivre à la lettre les instructions de montage de l'attelage.
- Présenter l'attelage sous le véhicule avant d'effectuer le montage.
- Si des forages sont nécessaires, s'assurer de l'absence de câbles électriques, de freinage ou autres. Enlever la couche d'antitremblement ou couche de bétume et traiter les tôles ou tubes forés avec un produit anti-corrosif.
- Si le véhicule est équipé de pare-chocs non standards (séries spéciales, kits sport, tuning ...), il est impératif de consulter le service technique de GDW avant de procéder au montage.

L'attelage livré est uniquement monté pour stockage, il faut démonter les parties!

Garantie

- Afin de savoir le poids tractable correct du véhicule, il faut vérifier le certificat de conformité ou contacter votre fournisseur. Les spécifications techniques de l'attache-remorque ne peuvent pas être dépassées. Voyez la formule à la page 5.
- L'attelage doit être contrôlé après les 1.000 premiers km d'utilisation et ensuite au moins une fois par an:
 - * Contrôler toute la visserie et resserrer si nécessaire
 - * Réparer les dommages qu'aurait subi la peinture
 - * Remplacer les pièces qui auraient été endommagées suite à un accident ou une collision
 - * Graisser les parties intérieures des attelages escamotables

Utilisation

- Si la rotule ou la boule est positionnée devant la plaque d'immatriculation ou le feu anti-brouillard, il est OBLIGATOIRE de la retirer quand elle n'est pas utilisée !

Fitting

- Make sure that the tow bar has not been damaged during transport and it is the right reference for the vehicle.
- Read the fitting instruction before starting and follow them very precisely during the fitting.
- Present the towbar under the car first to check if all points are right.
- If holes have to be drilled, check that no wires can be damaged, remove all soundproofing material, clean and protect the drilled holes with an anticorrosive product.
- If the vehicle is equipped with special bumpers (sport or tuning parts...) first contact the technical service of GDW to be sure that the tow bar can be fitted.

The towbar delivered is only for storage, the parts have to be disassembled!

Guarantee

- To know the max. trailer weight of your car, please refer to the Certificate of conformity or contact your dealer. The specifications of the towbar must not be exceeded. See formula on page 5.
- The tow bar has to be checked after 1.000 km and every year:
 - * All bolts should be checked and retightened if necessary
 - * Repair any damage to the paint finish
 - * Replace any damaged components
 - * Parts of the detachable tow bars must be kept well greased.

Use

- If the towing ball covers the number plate or the fog light, it must always be removed when no trailer is used.

Montage

- Vor Anfang der Montage muss die Anhängerkupplung auf Transportschäden kontrolliert werden.
- Aufmerksam die Anbauanleitung zu Rate ziehen. Alle Anweisungen sollen befolgt werden.
- Erst die Anhängerkupplung und das Fahrzeug kontrollieren, danach montieren.
- Vor dem Bohren der Löcher prüfen dass anwesende Kabel nicht beschädigt werden können. Den Antiröhnschutz und Unterbodenschutz entfernen. Gebohrte Löcher und Karosserieunterteile mit einer korrosionsfesten Farbe behandeln.
- Falls das Fahrzeug keine Standardstoßstangen hat (spezielle Serie, Sportausführungen, Tuning ...), muss Aussparung nachprüfen. Im Zweifelsfall, GDW kontaktieren.

Die gelieferte Anhängerkupplung ist für die Lagerung montiert, bitte die Unterteile abmontieren!

Garantie

- Falls Sie die richtige Anhängelast Ihres Fahrzeuges wissen möchten, brauchen Sie nur das COC-Zertifikat zu kontrollieren oder den Lieferanten zu kontaktieren. Die technischen Daten der Anhängervorrichtung dürfen nicht überschritten werden. Sie die Formel auf der Seite 5.
- Nach 1.000 Km Gebrauch und wenigstens 1 Mal pro Jahr muss die Anhängerkupplung nachgeprüft werden:
 - * Alle Bolzenverbindungen nachprüfen und nachziehen falls nötig.
 - * Beschädigungen an der Farbe ausbessern.
 - * Falls die Anhängerkupplung durch eine extreme Belastung beschädigt wurde muss diese ersetzt werden.
 - * Die innere Teile vom abnehmbaren System einfetten.

Gebrauch

- Falls die Kugel von der Anhängerkupplung das Kennzeichen oder den Nebelscheinwerfer ganz oder zum Teil verdeckt, muss diese bei Nichtgebrauch, entfernt werden.

Montaje

- Asegurarse de que el enganche no ha sido dañado durante el transporte. Verificar la referencia. Leer las instrucciones de montaje y seguir los pasos que se indican.
- Presentar el enganche debajo del vehículo antes de realizar el montaje.
- Si es necesario hacer orificios asegurarse de que no hay cables eléctricos, de frenado u otros.
- Las piezas que se tienen que taladrar hay que tratarlas con un producto anticorrosión.
- Si el vehículo está equipado de un para golpes que no es de serie (especiales, kits sport, tuning...), informarse antes de montar el enganche ya que puede no servir si el paragolpes no es estándar.

Antes iniciar el montaje del enganche separar las piezas que lo componen!

Garantía

- Para conocer el peso que puede remolcar su coche, hay que controlar el certificado de conformidad, o contactar su proveedor. No sobre pasar las cargas máximas. Leer la formula pagina 5.
- El enganche debe revisarse después de los 1000 kilómetros de utilización y después una vez al año:
 - * Revisar toda la tortillería y apretarla si fuera necesario
 - * Reparar la pintura dañada
 - * Reemplazar piezas en caso de colisión
 - * Engrasar las partes interiores del enganche extraíble

Utilización

- Si la bola tapa la matrícula o la luz antiniebla, es OBLIGATORIO quitar la bola cuando no se utiliza!

Montering

- Før montering skal anhængertrækket kontrolleres for evt. transportskader og at det passer til den pågældende bil.
- Læs monteringsvejledningen før start og følg alle anvisninger under monteringen.
- Hvis det er nødvendigt at børe og/eller skære i bilens metaldele, sørg for at ingen ledninger er i vejen. Snitfladerne skal behandles med et rusthæmmende middel, og metalspånér skal fjernes.
- Hvis bilen er udstyret med speciel kofanger (speciel serie, sportsudstyr og lign.), så kontakt først Dansk Anhængertræk GDW for at sikre, at anhængertrækket kan monteres.
- Påse at der ikke kommer voks, støjdempningsmateriale, olie eller lign. på bolte og møtrikker. Dette giver en dårlig friktion i gevindet, hvilket kan resultere i løsdrejning af boltene.
- Eventuel "gummihud" eller undervognsbeskyttelse o.l. skal fjernes, hvor anhængertrækket ligger an mod vognbund eller vange.

Garanti

- Alle bolte skal efterspændes efter ca. 1.000 km's brug.
- Det er ikke tilladt at lave konstruktionsændringer på anhængertrækket. Eksempler på konstrukti onsændringer er svejsning og boring.
- Har et anhængertræk været udsat for ydre påvirkninger, f.eks. en trafikulykke eller anden form for påkørsel, er det ikke længere sikkert og bør straks udskiftes.
- Den anførte maksimale belastning/D-værdi samt kugletrykket må ikke overskrides.
- Trækket vil som regel have en større maksimal belastning/D-værdi og maksimalt kugletryk end bilen. Ved brug af trækket skal man derfor være opmærksom på, hvilken koblingsvægt og maksimal kugletryk, som er angivet i bilens papirer.
 - * Kuglen skal altid være rengjort og indsmurt i fedt. Hvis man anvender en kuglekobling med slingrestabilisator, følges dog anvisningerne fra fabrikanten af slingrestabilisatoren.
 - * Kuglediameteren skal regelmæssigt måles. Den må ikke være under 49 mm.
 - * Dansk Anhængertræk GDW A/S kan ikke gøres ansvarlig for ukorrekt montage eller ukorrekt brug af anhængertrækket.
 - * Hvis anhængertrækket dækker nummerplade eller tågelygte, skal kuglen altid være afmonteret, når anhængertrækket ikke er i brug.

See the Certificate Of Conformity (COC) of your vehicle or contact your dealer to verify the max. trailer weight of your car!



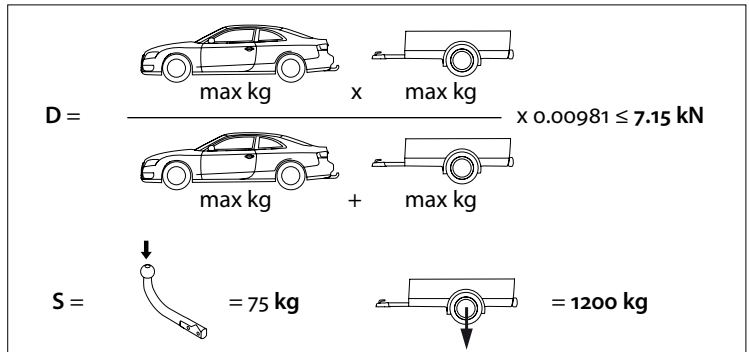



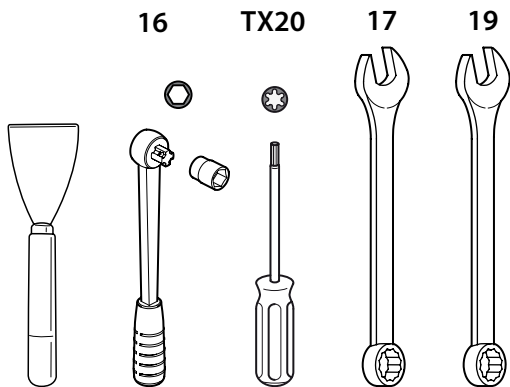
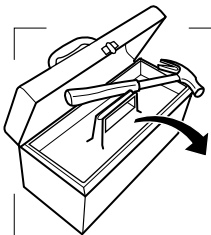

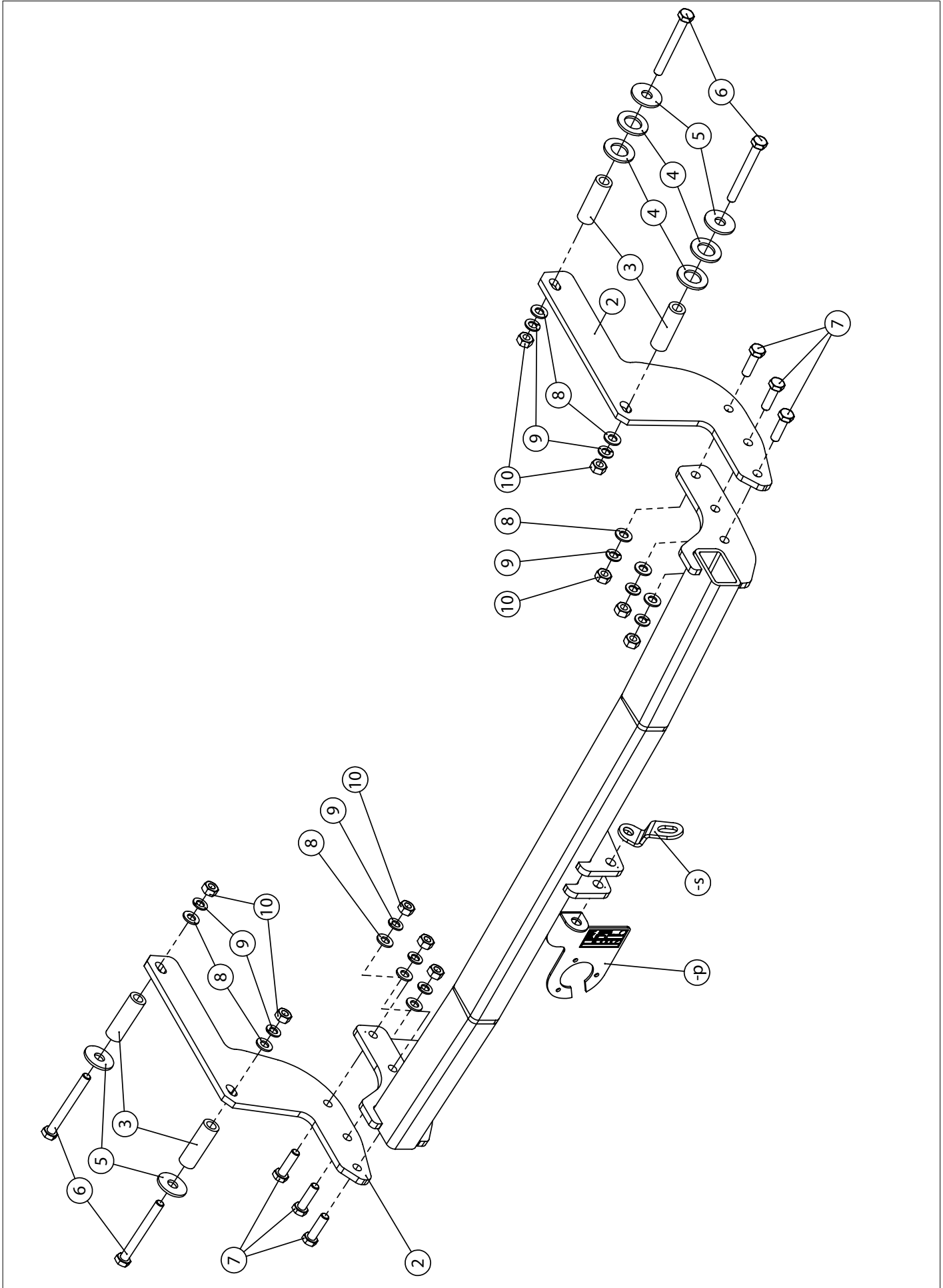

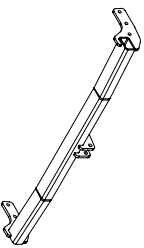
MADE BY	D 7.15	F	E6
		EC APPROVAL N°	
BELGIUM	S 75	55R-011047	
REF N°			
SERIE N°			
OMSCHRIJVING	Renault Captur '13		









	M 6	M 8	M 10	M 12	M 14	M 16
8.8	10,4 Nm	25,0 Nm	51,0 Nm	87,0 Nm	140,0 Nm	215,0 Nm
10.9	15,5 Nm	37,0 Nm	75,0 Nm	130,0 Nm	205,0 Nm	310, Nm
12.9	18,0 Nm	43,0 Nm	87,0 Nm	150,0 Nm	240,0 Nm	370,0 Nm

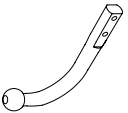

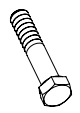

1		X1	GDW REF. 1972
2		X2	GDW REF. 2
3		X4	GDW REF. 3
4		X4	DIN125-A20-ELVZ
5		X4	DIN9021-M12-ELVZ
6		X4	DIN931-M10X90
7		X6	DIN933-M10X35
8		X10	DIN125-A10-ELVZ
9		X10	DIN128A-M10
10		X10	DIN934-M10
-P		X1	GDW REF. PO4

Geleverd met - Livré avec - Delivered with Geliefert mit - Elementos adjuntos-Leveres med		X1	T45H000
		X2	GDW REF. 800008
		X2	GDW REF. 800011 Ø 21,3 X 11,7
		X1	GDW REF. 800053
		X4	DIN931-M12 X 70
		X4	DIN985-M12

1

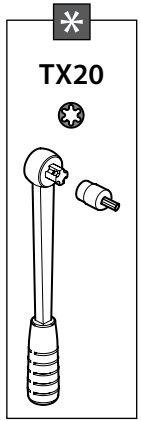
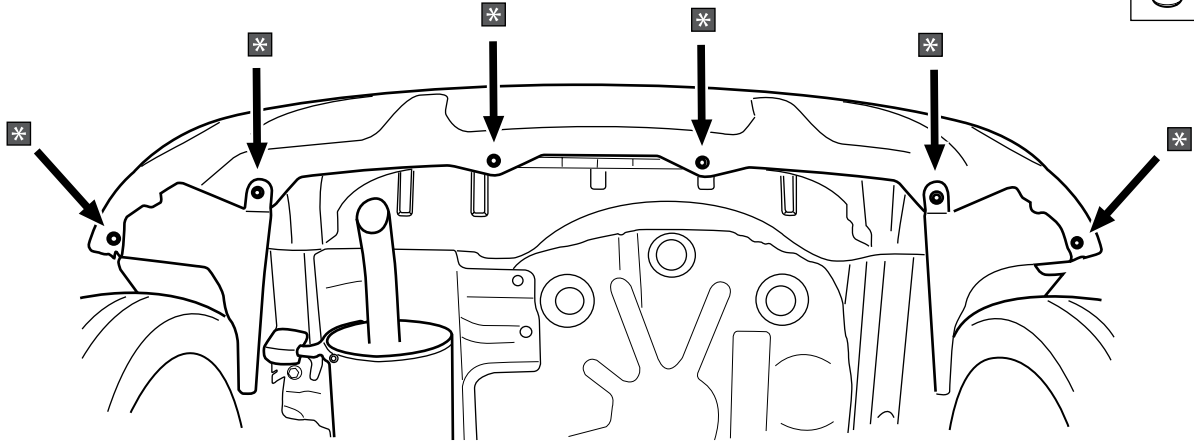
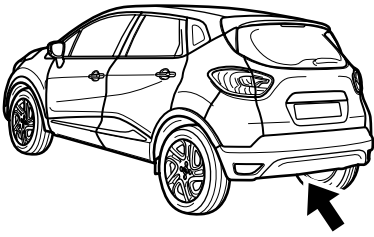

2

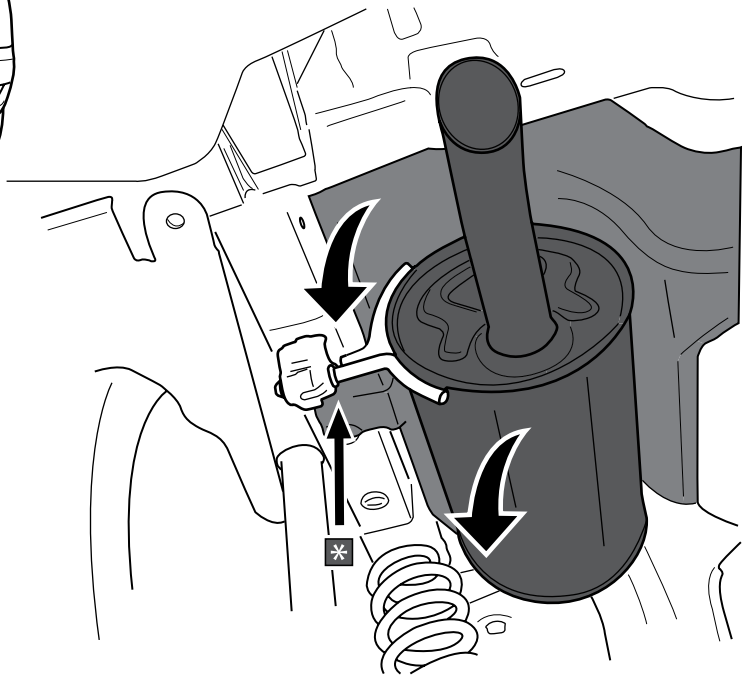
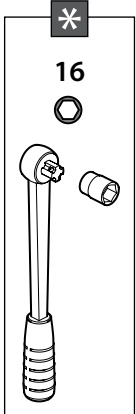
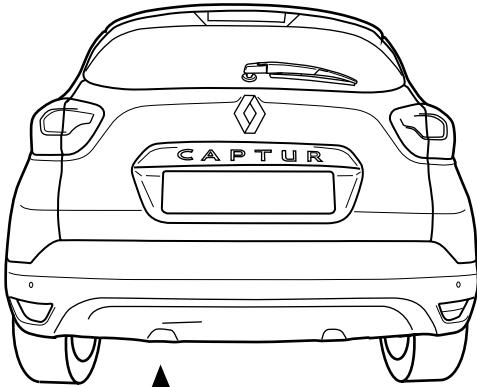

3

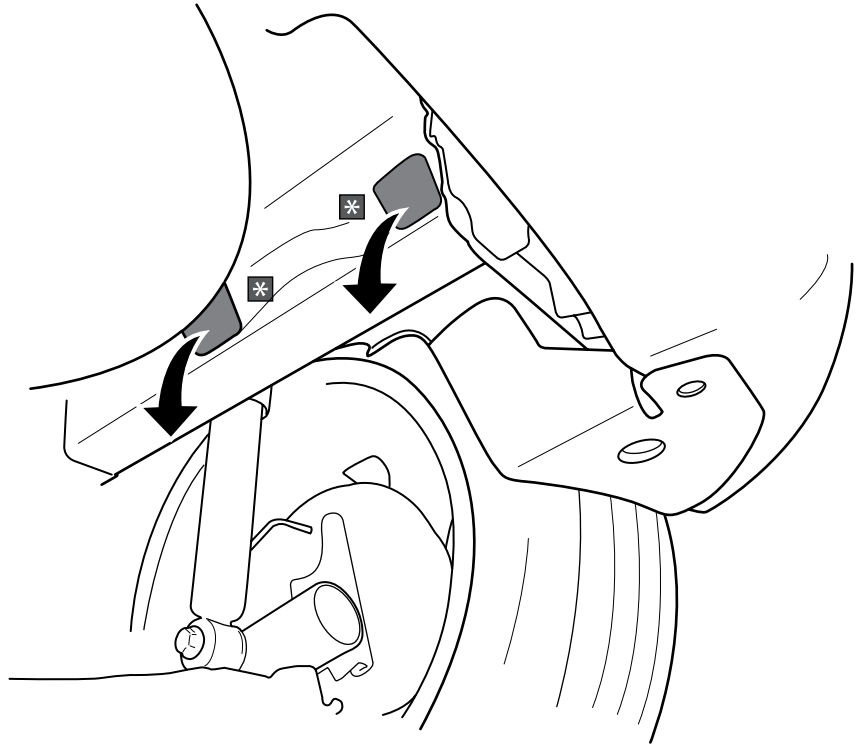
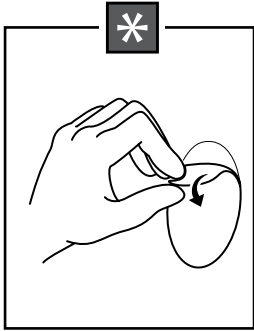
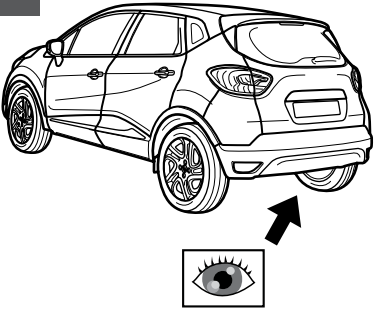

4

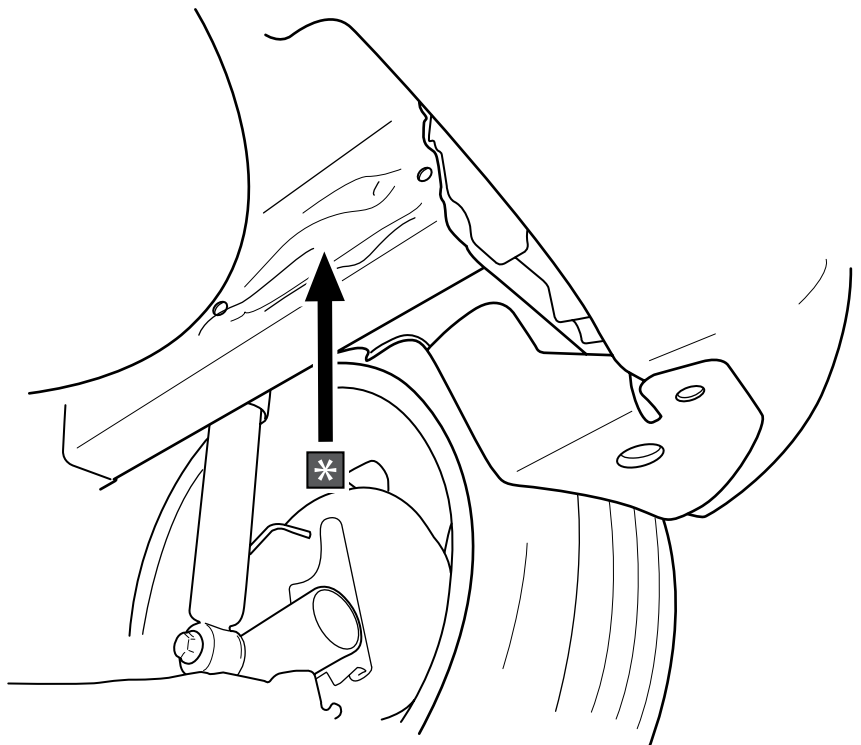
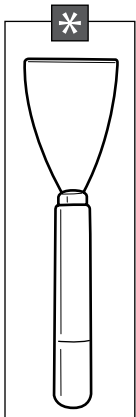
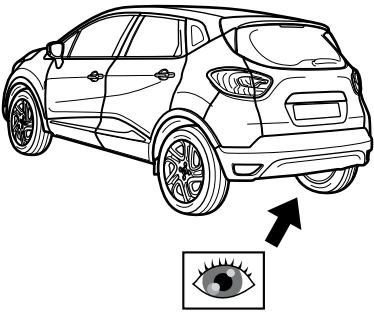

5

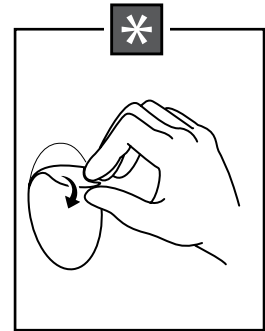
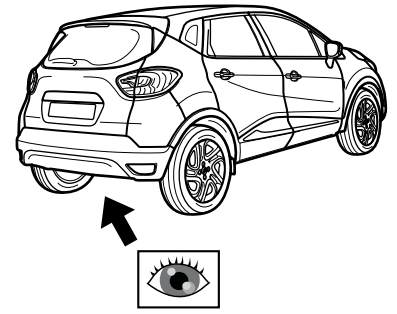
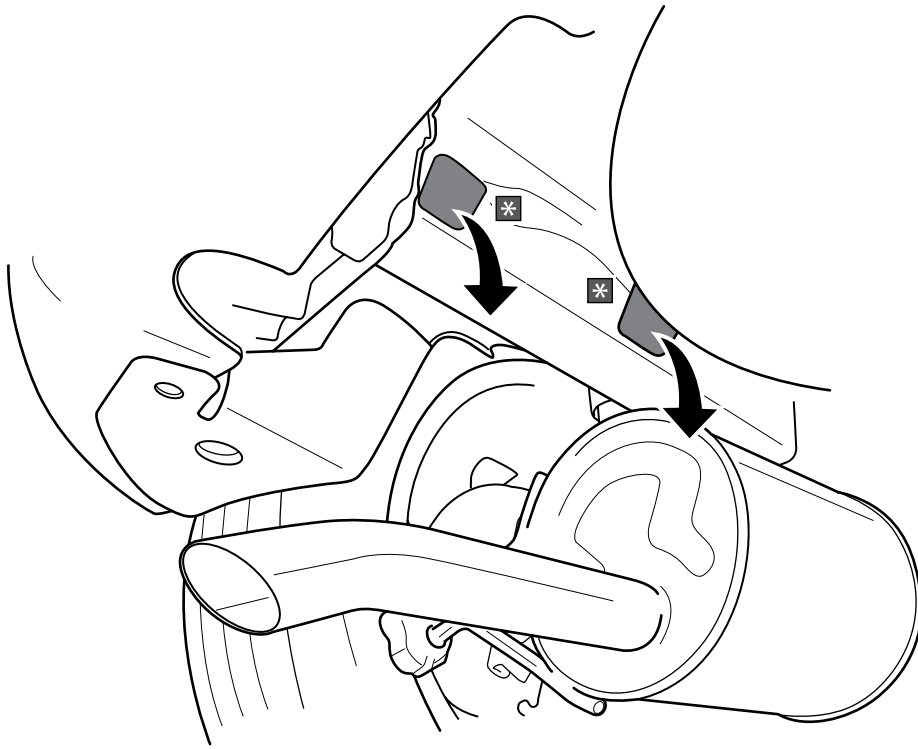

6

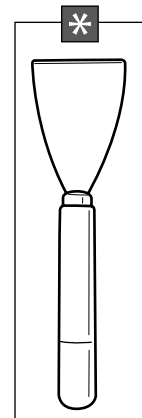
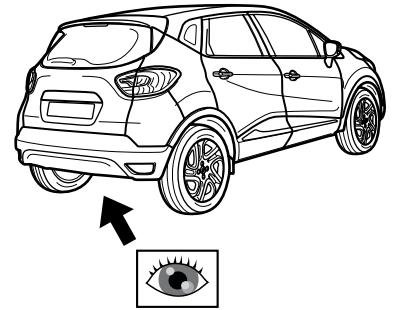
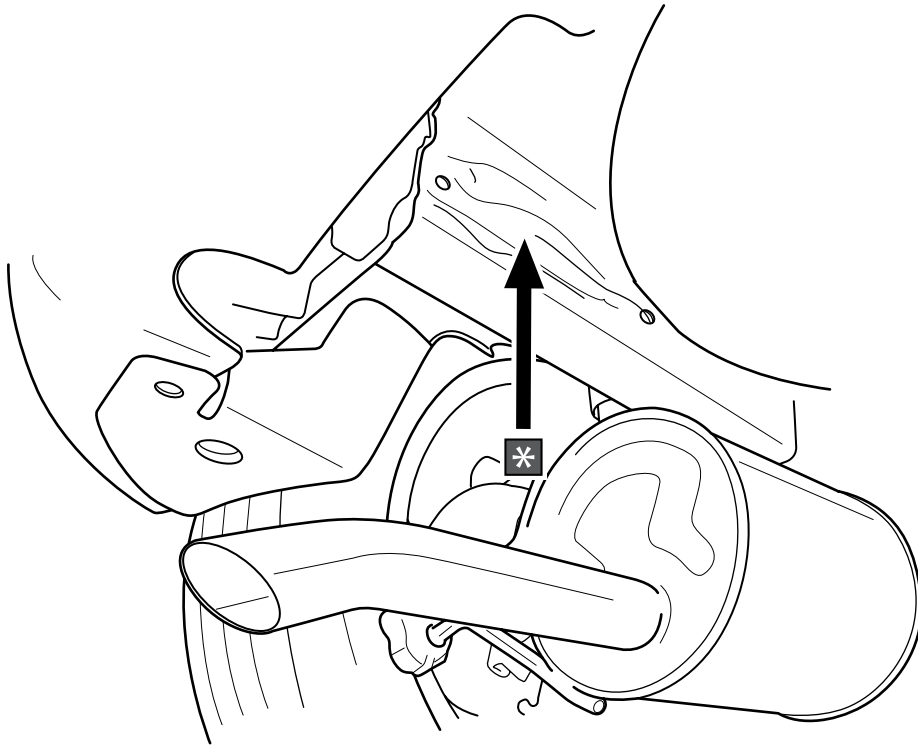

7

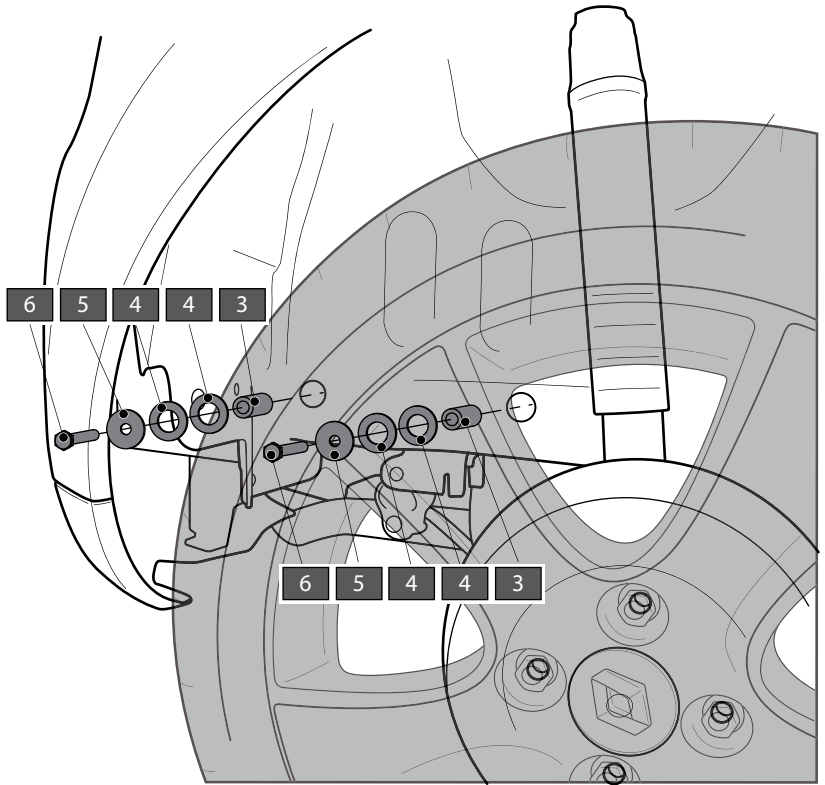
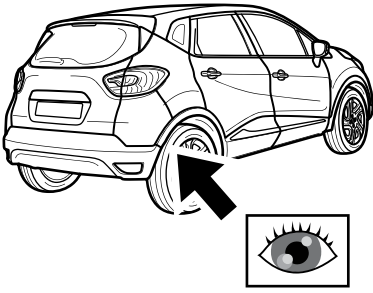

8

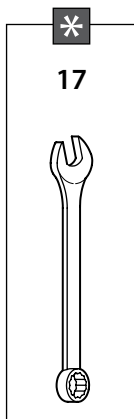
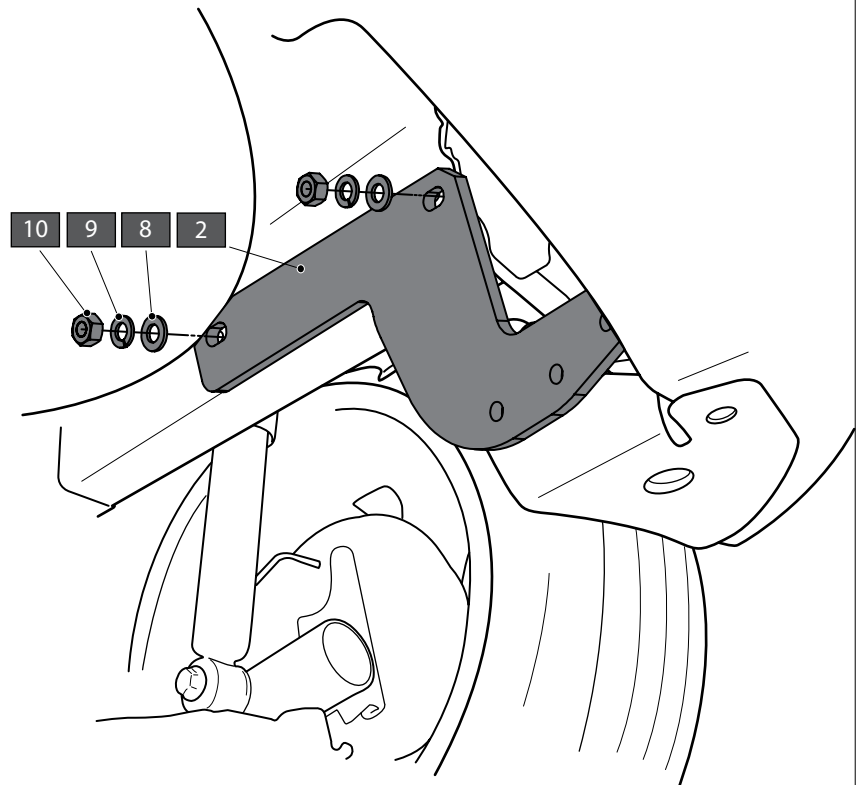
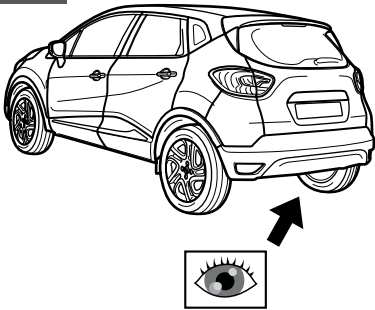

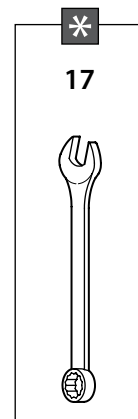
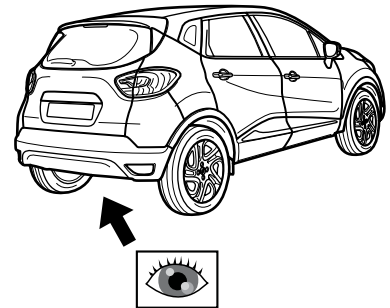
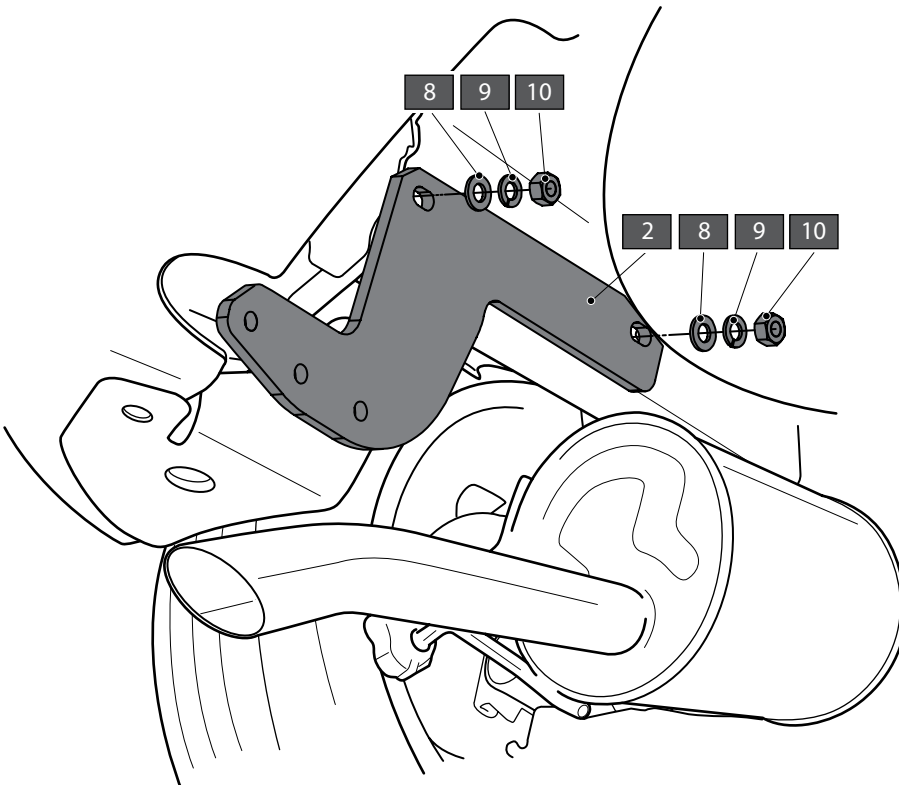
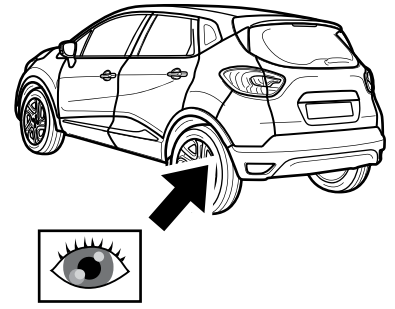
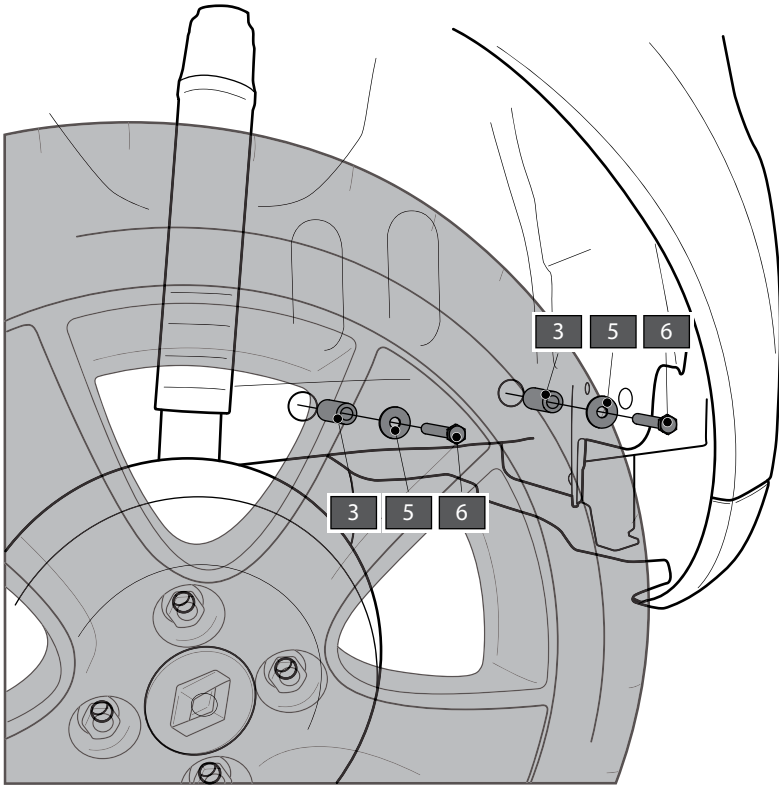

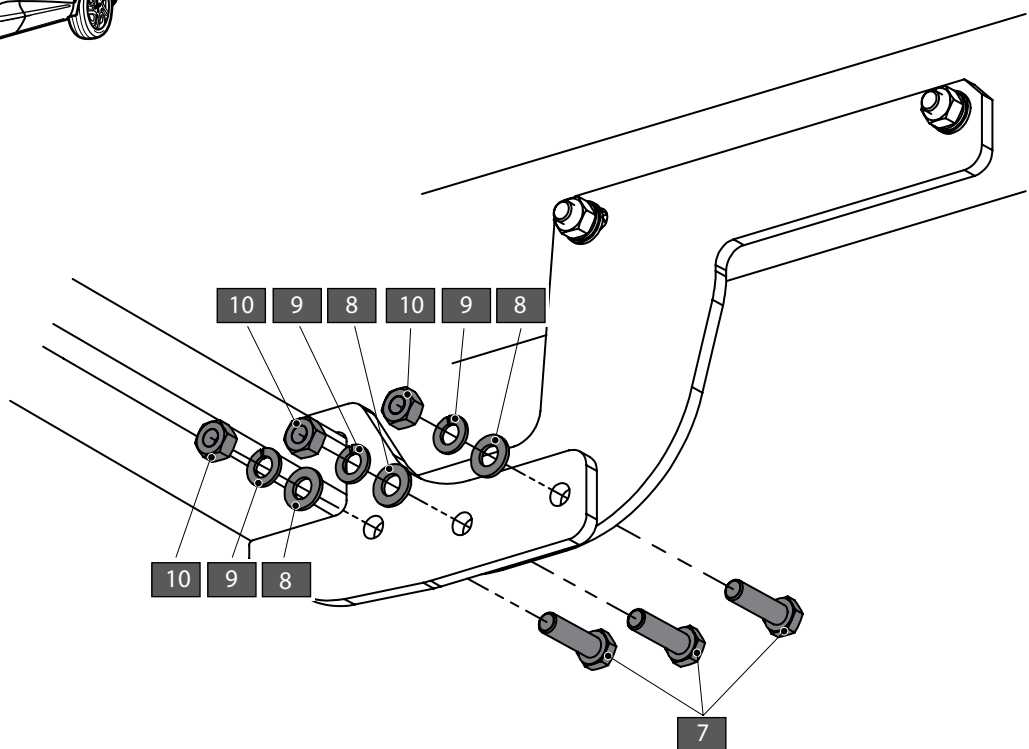
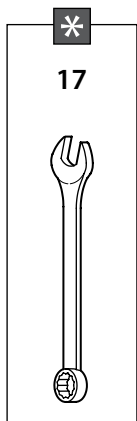
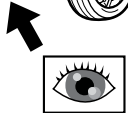
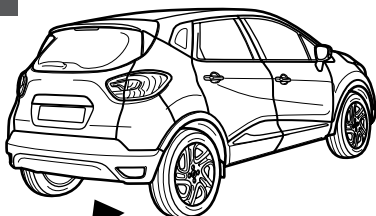
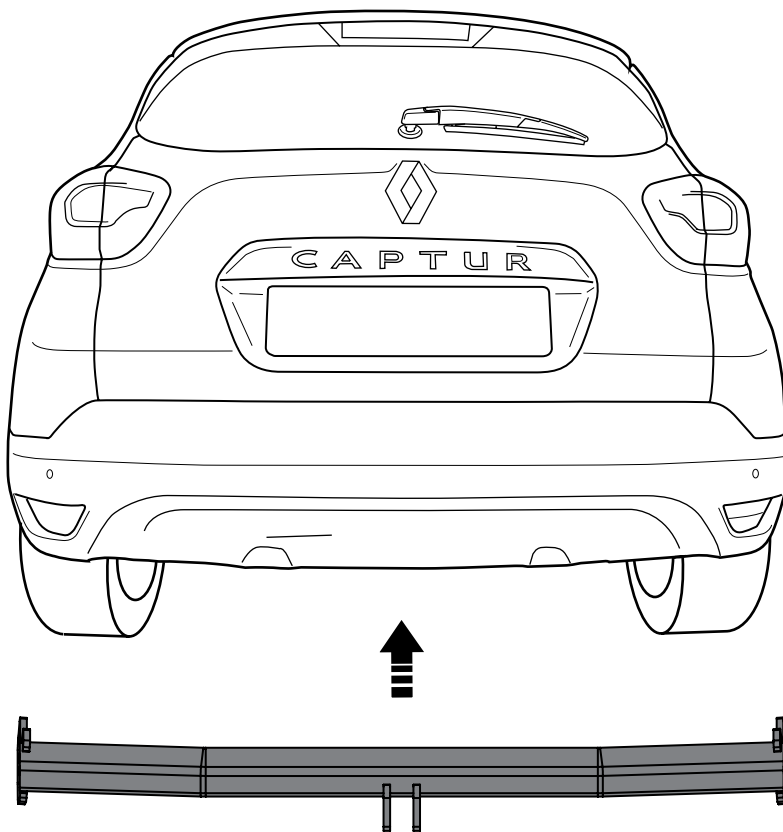

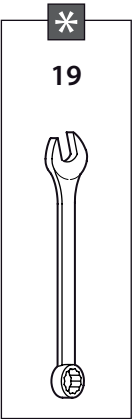
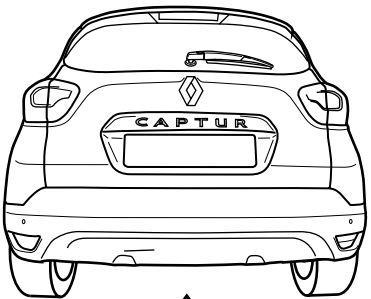
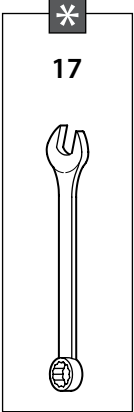
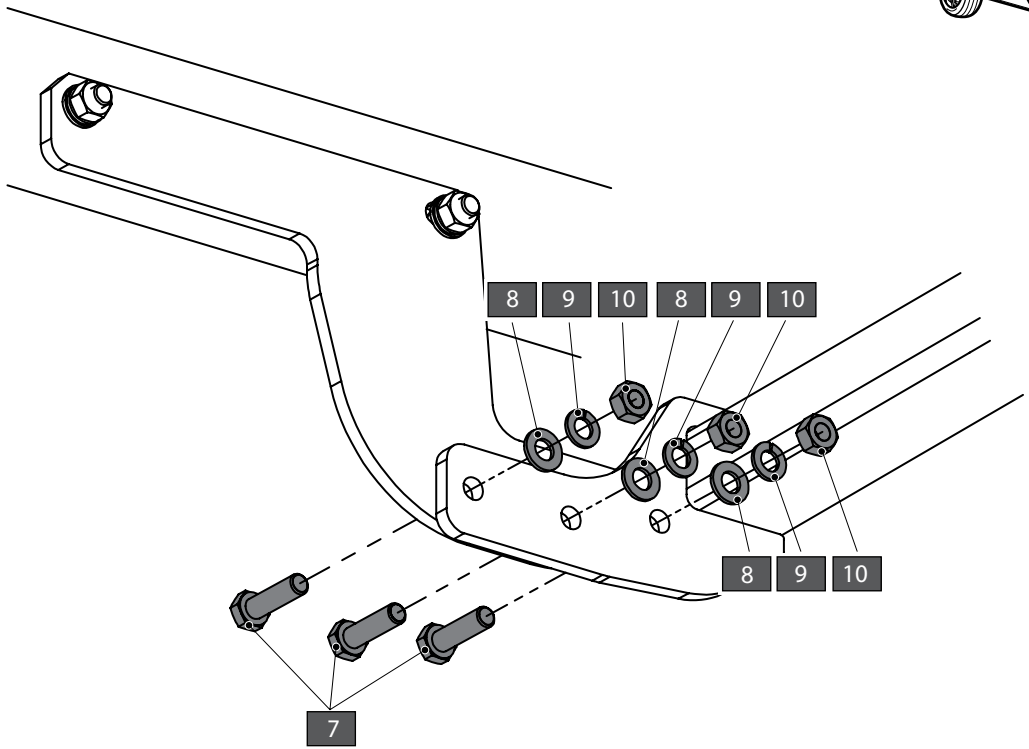
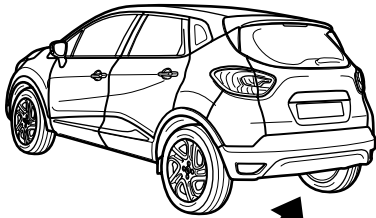

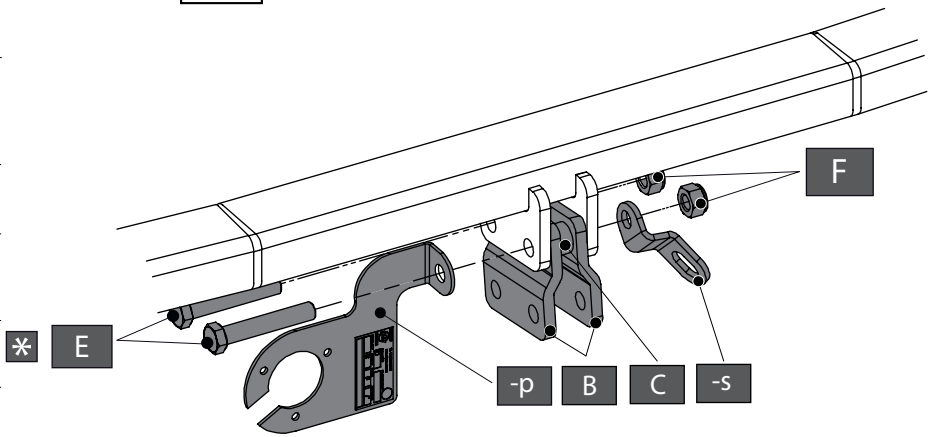

B		X2	GDW REF. 800008
C		X2	GDW REF. 800011 Ø 21,3 X 11,7
E		X2	DIN931-M12 X 70
F		X2	DIN985-M12
-S		X1	GDW REF. 800053

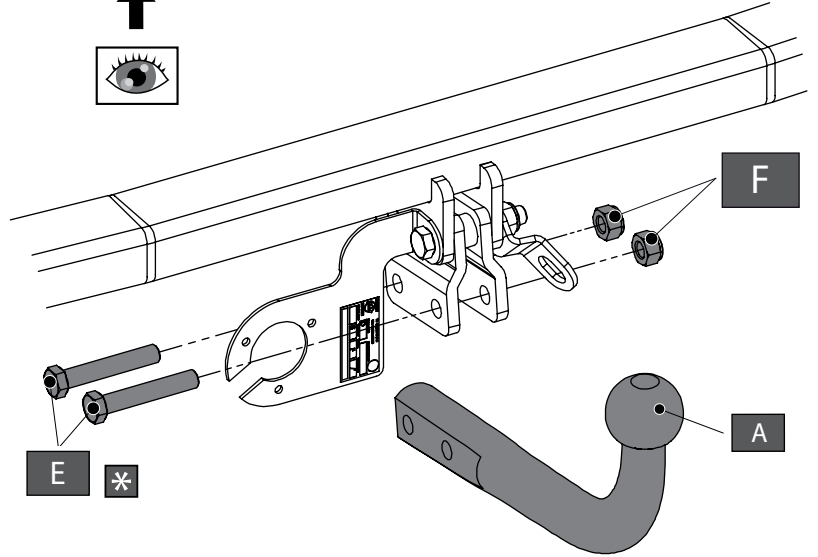
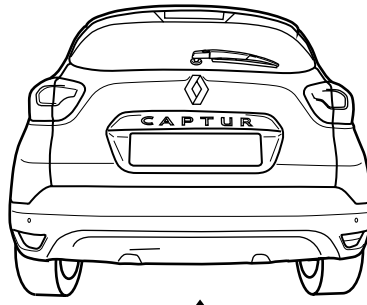
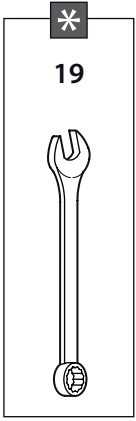

15

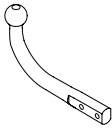
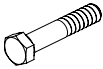

A		X1	T45H000
E		X2	DIN931-M12 X 70
F		X2	DIN985-M12

16

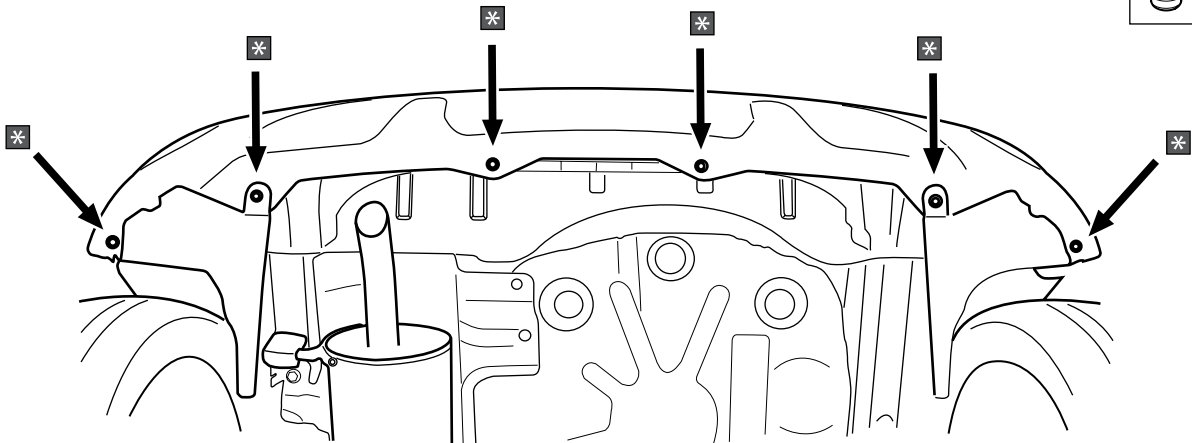
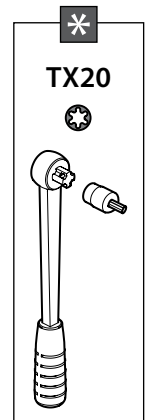
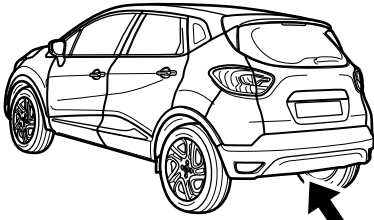

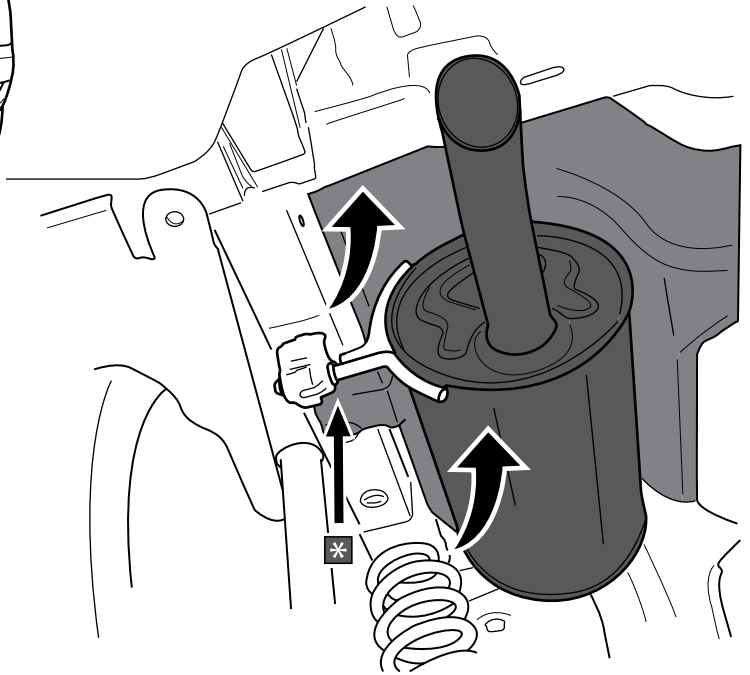
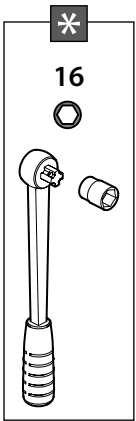
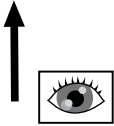
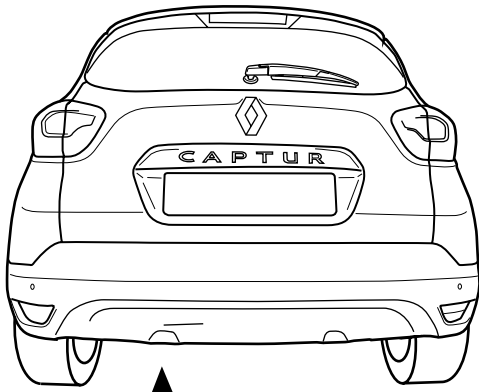

Opties - Options - Options - Optionen - Opciones - Muligheder

