

316364600001 / 316365600001 / 316366600001

ATTENTION : (pour connaître les caractéristiques d'utilisation consulter la carte grise).

Installé suivant nos recommandations, cet attelage vous donnera entière satisfaction. Nous dégageons toute responsabilité en cas de transformation ou d'utilisation illicite de celui-ci

FR

ACHTUNG: (Nutzungsmerkmale : siehe Fahrzeugschein)

Diese Anhängervorrichtung wird Sie voll zufrieden stellen, wenn Sie unsere Montageanleitung befolgen. Im Falle der unerlaubten Veränderung oder des unerlaubten Gebrauchs lehnen wir jede Haftung ab.

DE

PLEASE NOTE : (to familiarise yourself with the operating characteristics refer to the log).

If this tow bar is fitted in accordance with our recommendations it will give a completely satisfaction. We cannot accept any responsibility in the event of changes to or improper use of this item.

EN

BEMÆRK : (for yderligere oplysninger om anvendelsesforhold henvises der til registreringsattesten)

Hvis dette anhængertræk monteres i henhold til vores anvisninger, vil det være til din fulde tilfredshed. Vi fralægger os ethvert ansvar ved ulovlig ændring eller brug af anhængertrækket.

DA

ΠΡΟΣΟΧΗ : (για να πληροφορηθείτε τα χαρακτηριστικά χρήσης συμβουλευτείτε την γκριζα κάρτα)

Εγκατεστημένο σύμφωνα με τις συστάσεις μας, αυτό το σύστημα ρυμούλκησης θα σας ικανοποιήσει πλήρως. Απεκδυόμεθα πάσης ευθύνης σε περίπτωση μετατροπής ή παράνομης χρήσης αυτού.

EL

ATENCIÓN: (para conocer las características de utilización, consultar el permiso de circulación)

Instalado siguiendo nuestras recomendaciones, este enganche le dará total satisfacción. No asumiremos ninguna responsabilidad en caso de que haya sido transformado o utilizado ilícitamente.

ES

UWAGA (charakterystyki użytkowania należy sprawdzić w dowodzie rejestracyjnym)

Dyszel holowniczy będzie funkcjonował we właściwy sposób po zainstalowaniu go zgodnie z zaleceniami. Nie ponosimy żadnej odpowiedzialności w przypadku wprowadzenia zmian lub niedozwolonego użycia

PL

HUOMIO: (käyttöominaisuuksiin tutustumiseksi on katsottava rekisteriotetta)

Suosituksen mukaan asennettuna tämä vetokoukku täyttää odotuksesi. Emme ota vastuuta, jos laitetta muutetaan tai käytetään ohjeiden vastaisesti.

FI

ATTENZIONE : (per conoscere le caratteristiche d'uso consultare il libretto di ircolazione)

Installato seguendo le nostre raccomandazioni, questo gancio da traino vi lascerà completamente soddisfatti. Respingiamo ogni responsabilità in caso di trasformazione o utilizzo illecito dello stesso.

IT

LET OP : (voor gebruikskennmerken het kentekenbewijs raadplegen)

Indien u de koppeling volgens onze aanbevelingen heeft geïnstalleerd, zal het u tot volle tevredenheid stemmen. Wij stellen ons niet aansprakelijk in geval van wijziging of onrechtmatig gebruik.

NL

ADVARSEL: (for kunnskap om bruksegenskapene, se vognkortet)

Ved å installere innretningen i samsvar med våre anbefalinger vil du få maksimalt utbytte av dette tilhengerfestet. Vi fraskriver oss alt ansvar hvis tilhengerfestet endres eller brukes på ulovlig måte.

NO

POZOR: (užívateľské charakteristiky naleznete v technickém průkazu)

Tažné zařízení instalované dle našich doporučení vás plně uspokojí. V případě přestavby nebo neoprávněného užívání se zbavujeme veškeré odpovědnosti

CZ

VARNING: (Läs igenom registreringsbeviset för att ta reda på rådande användningsvillkor)

Om du monterar produkten enligt våra anvisningar kommer du uppnå bästa möjliga resultat. Vi avsägar oss allt ansvar i de fall kunden inte följer våra anvisningar fullt ut.

SV

FIGYELEM : (a használati jellegzetességeket a forgalmi engedélyből ismerheti meg)

A vonóhorog előírásainknak megfelelő felszerelés esetén a terméket teljes elégedettséggel használhatja. A termék átalakítása vagy tiltott használata esetén semmilyen felelősséget nem vállalunk.

HU

ВНИМАНИЕ : (чтобы ознакомиться с рабочими характеристиками, изучите технический паспорт автомашины)

Установленное при соблюдении рекомендаций, данное тягово-сцепное устройство в полной мере удовлетворит ваши потребности. Производитель не несет никакой ответственности в случае деформации или

RU



SIARR

WESTFALIA

316364600001 (SI 216)

316365600001 (SI 216)

316366600001 (SI 215)

DUSTER

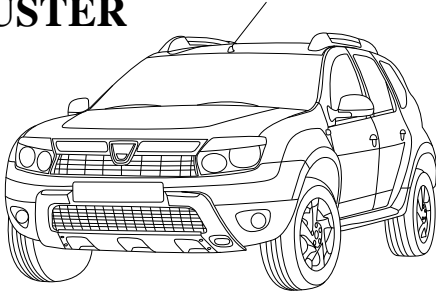

1600 kg

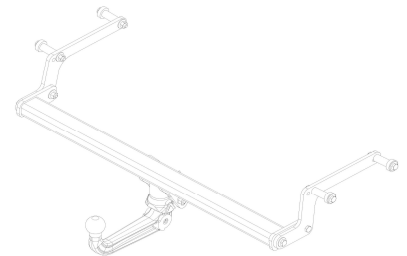

316364 : 18 kg

316365 : 16,5 kg

316366 : 18,5 kg



75 kg



1950 kg



e24*55R*01*0346 - 316364

e24*55R*01*0346 - 316365

e24*55R*01*0345 - 316366

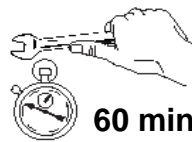
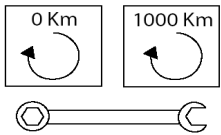

60 min



8,62 kN

316364

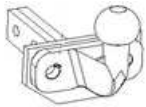

316365





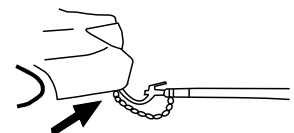
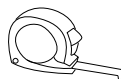
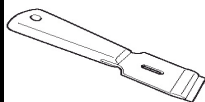
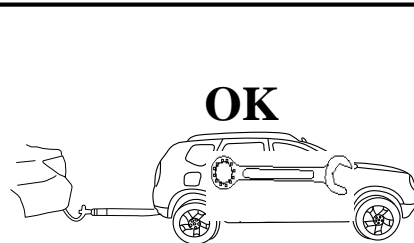
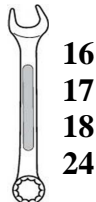
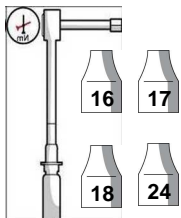
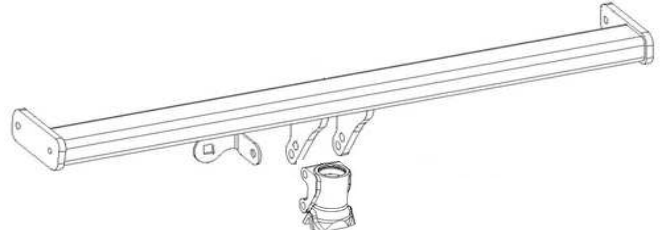
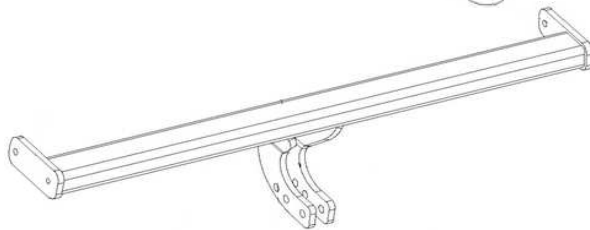
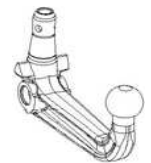



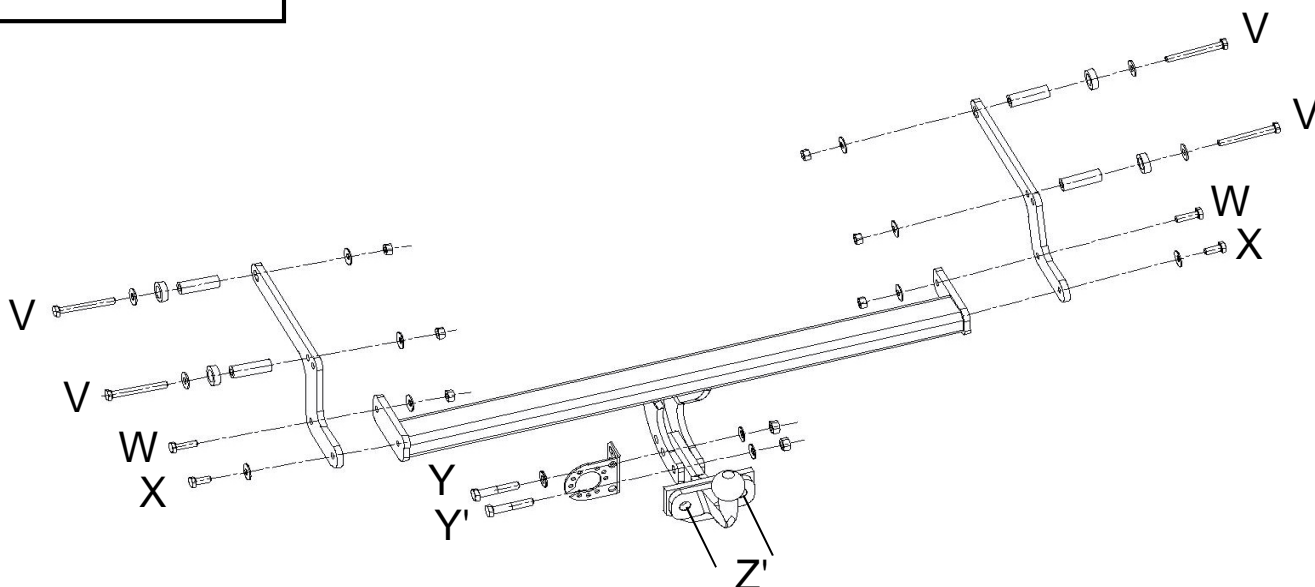













316366











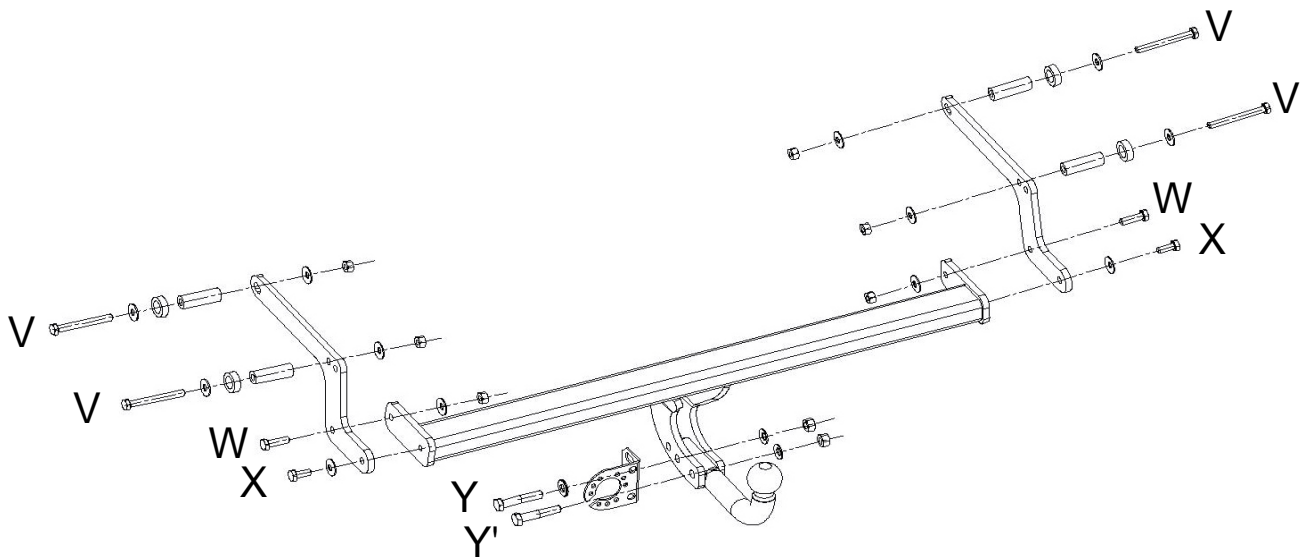









316364











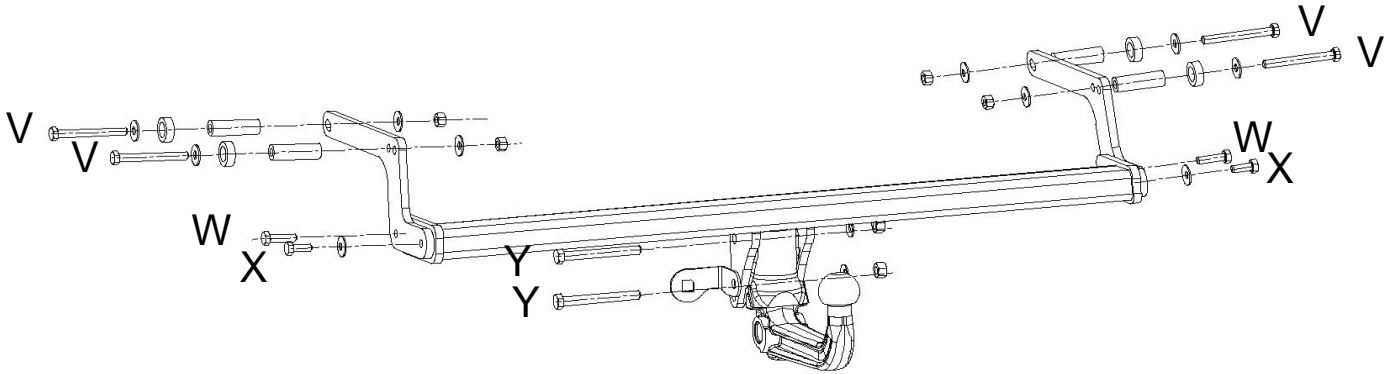





VISSERIE		QTÉ
V	 HM10x90 - cl8.8	x 4
	 L10,5/27	x 4
	 20/32 - ep.10mm	x 4
	 M10 - cl8	x 4
	 Ø10,5/20 - L. 60mm	x 4
W	 HM10x45 - cl8.8	x 2
	 CS10	x 2
	 M10 - cl8	x 2
X	 HM10x45 - cl 8.8	x 2
	 CS10	x 2
Y	 HM12x65 - cl 8.8	x 1
	 CS12	x 1
	 M12 - cl8	x 1
Y'	 HM12x65 - cl 8.8	x 1
	 CS12	x 1
	 M12 - cl8	x 1
	 D12	x 1
Z	 HM16x40 - cl 8.8	x 2
	 M16 - cl 8	x 2
	 DEC16	x 2

316365



VISSERIE		QTÉ
V	 HM10x90 - cl8.8	x 4
	 L10,5/27	x 4
	 20/32 - ep.10mm	x 4
	 M10 - cl8	x 4
	 Ø10,5/20 - L. 60mm	x 4
W	 HM10x45 - cl8.8	x 2
	 CS10	x 2
	 M10 - cl8	x 2
X	 HM10x45 - cl 8.8	x 2
	 CS10	x 2
Y	 HM12x65 - cl 8.8	x 1
	 CS12	x 1
	 M12 - cl8	x 1
Y'	 HM12x65 - cl 8.8	x 1
	 CS12	x 1
	 M12 - cl8	x 1
	 D12	x 1

316366

VISSERIE		QTÉ
V	 HM10x90 - cl8.8	x 4
	 L10,5/27	x 4
	 20/32 - ep.10mm	x 4
	 M10 - cl8	x 4
	 Ø10,5/20 - L. 60mm	x 4
W	 HM10x45 - cl8.8	x 2
	 CS10	x 2
	 M10 - cl8	x 2
X	 HM10x45 - cl 8.8	x 2
	 CS10	x 2
Y	 HM12x65 - cl 8.8	x 2
	 CS12	x 2
	 M12 - cl8	x 2

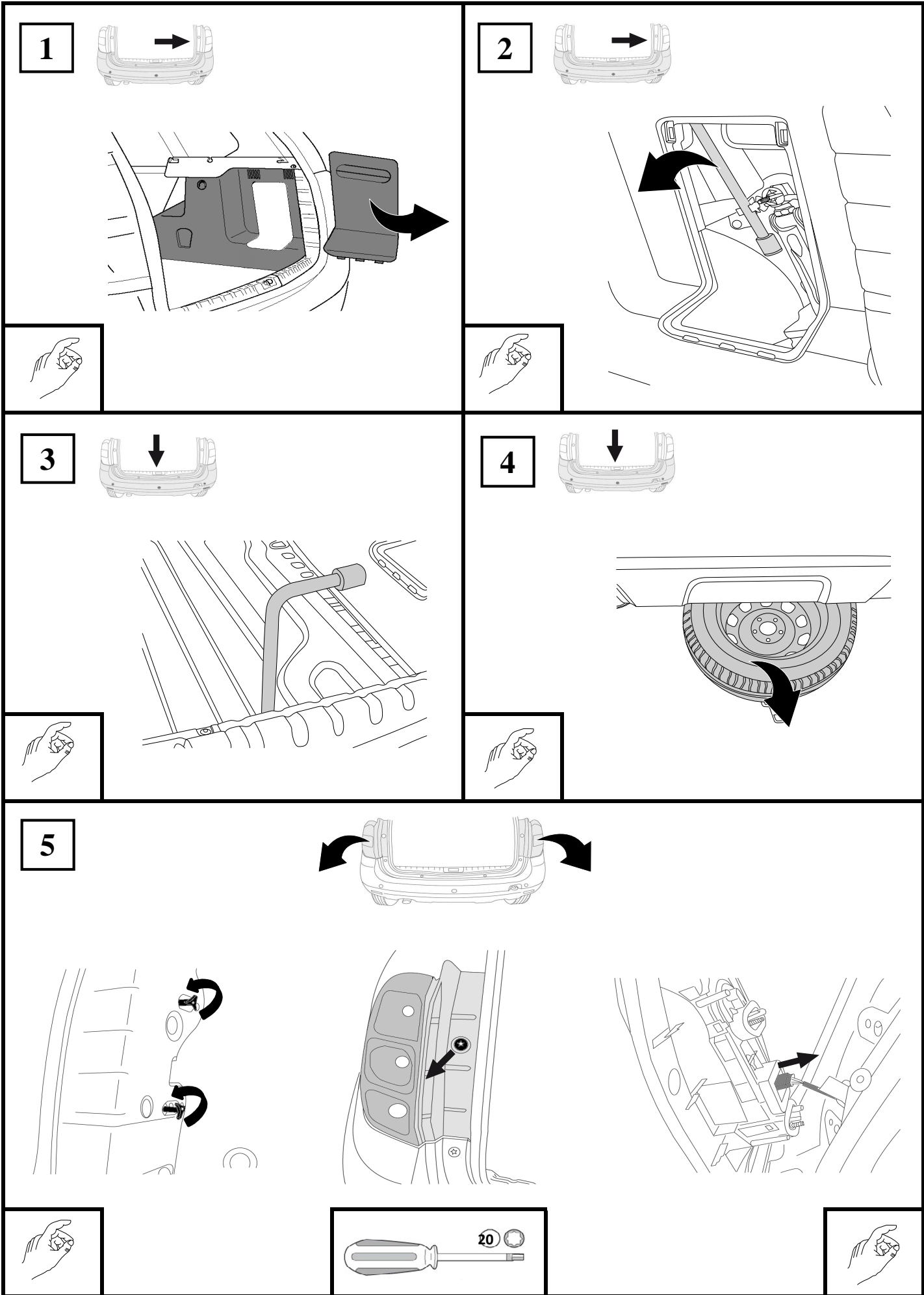

6

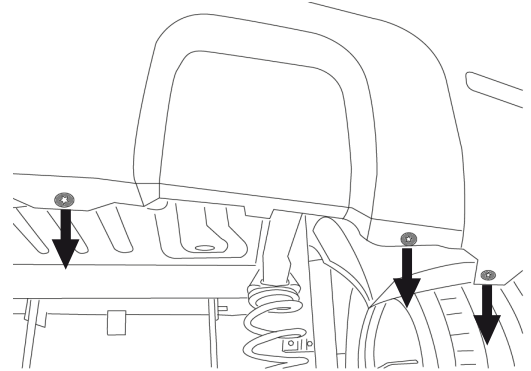
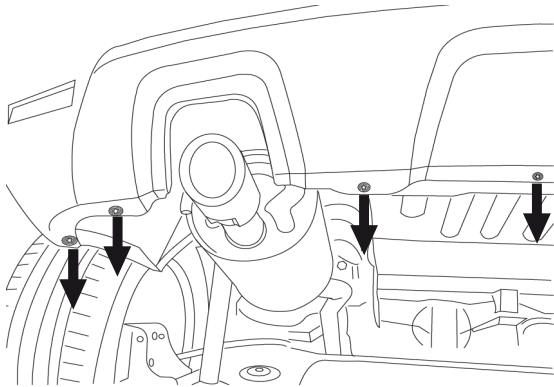
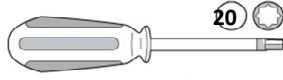
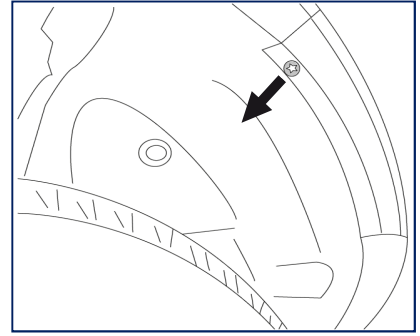
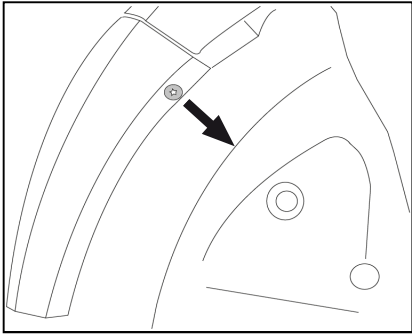
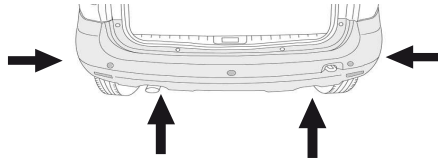

7

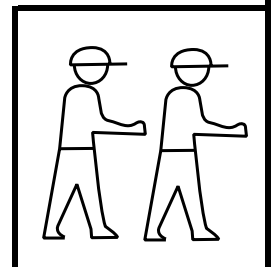
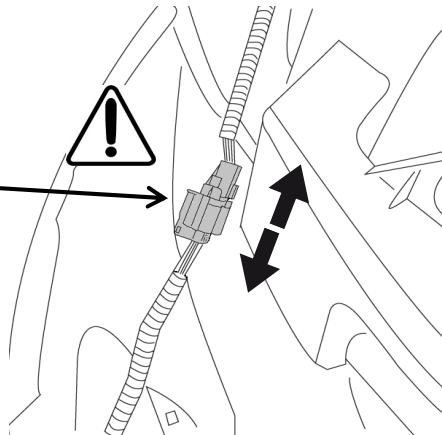
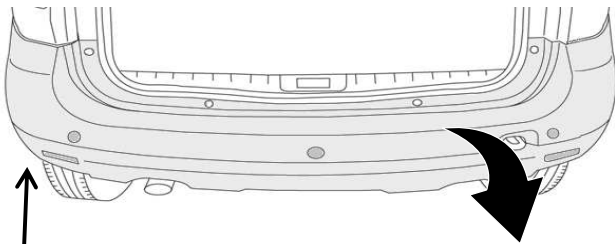
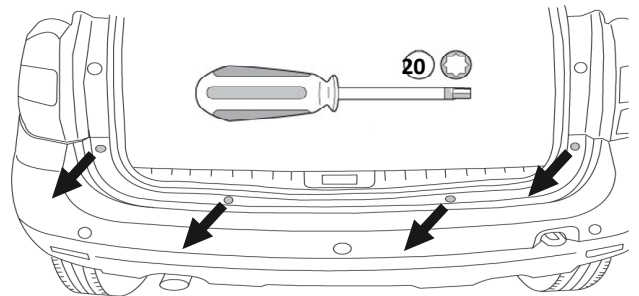
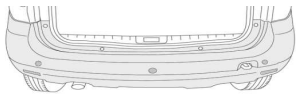

8

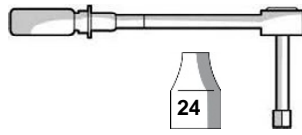
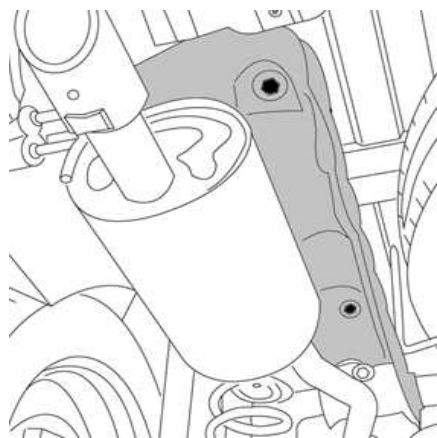
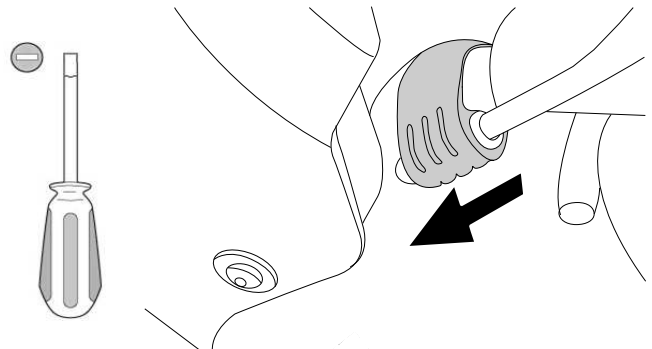

24

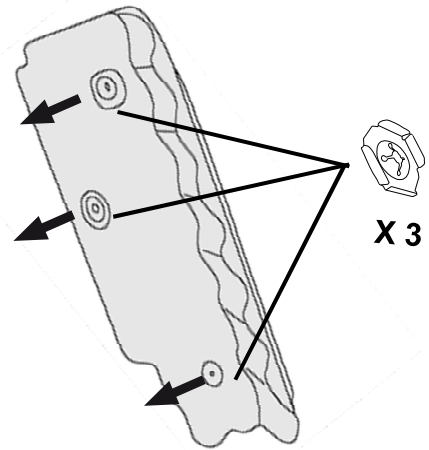

X 3

9

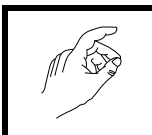
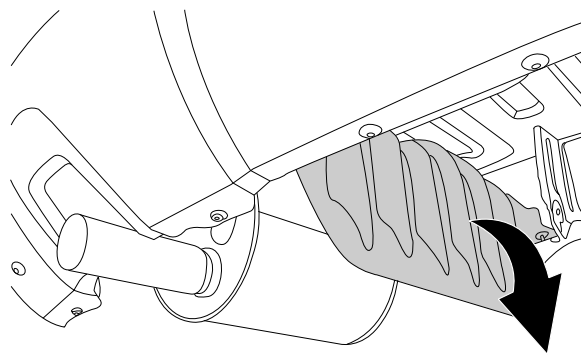

10

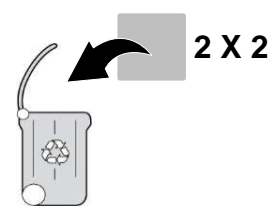
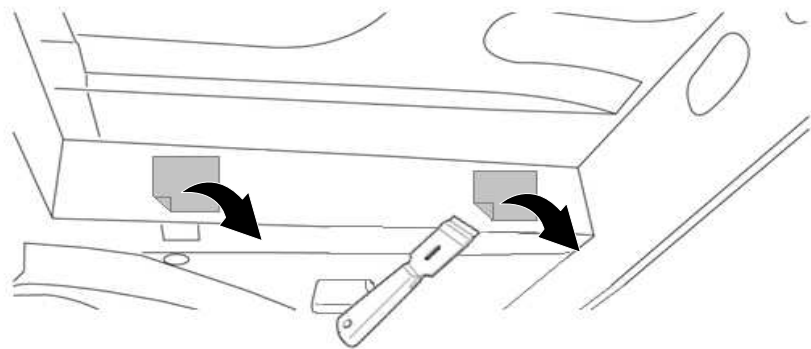
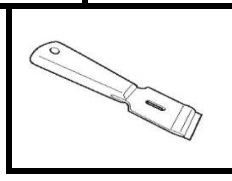
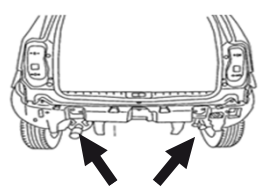

2 X 2

11

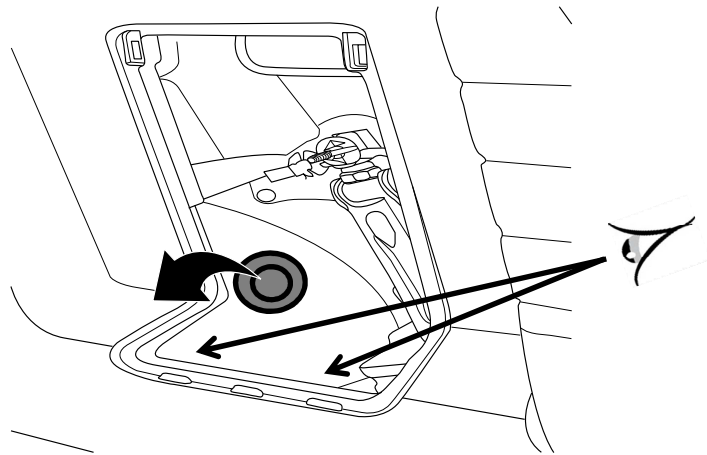
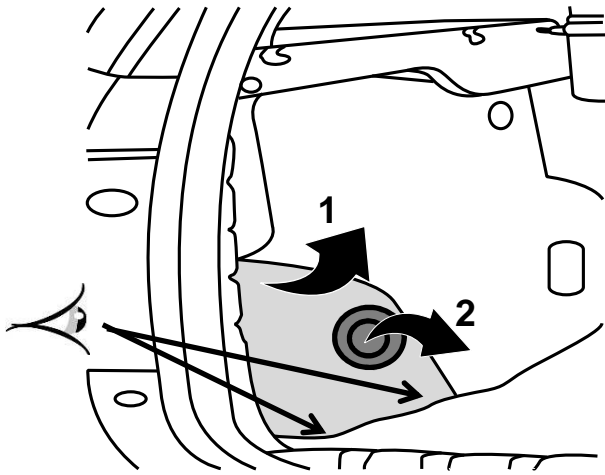
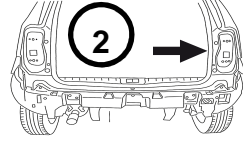
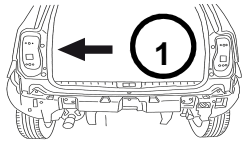

x 2

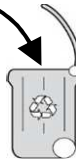

x 2



12

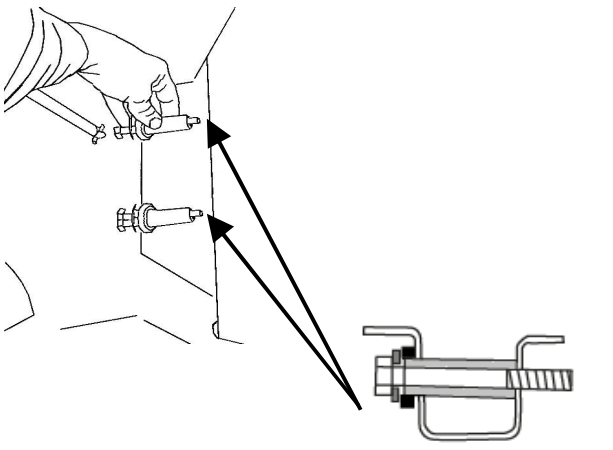
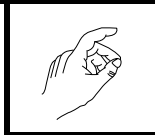
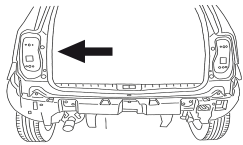

13

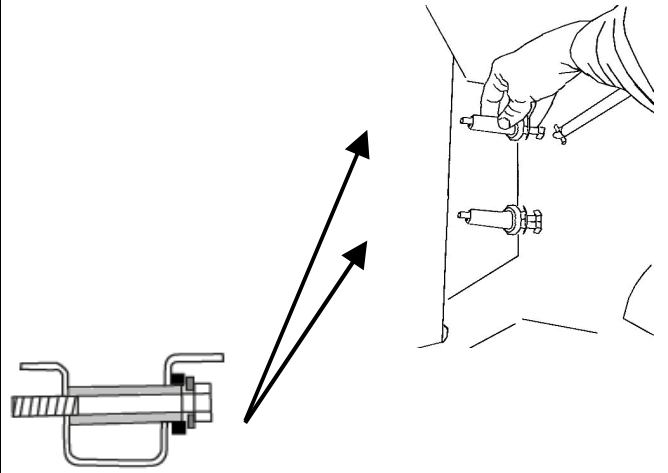
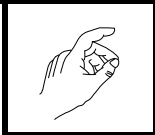
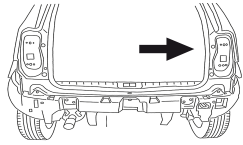

14

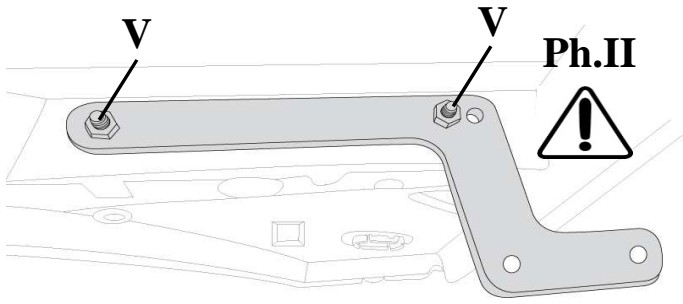
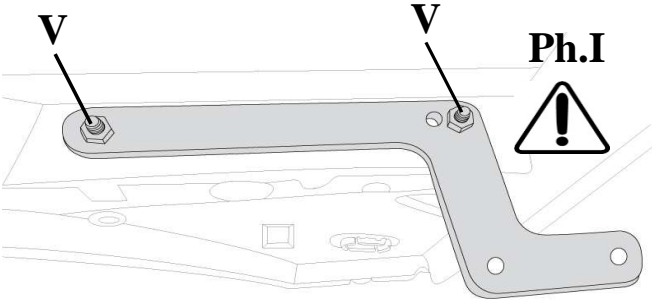
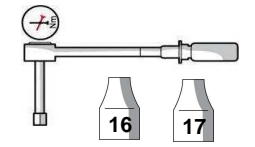
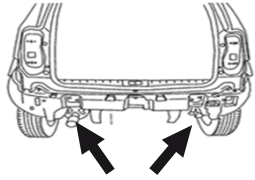

15

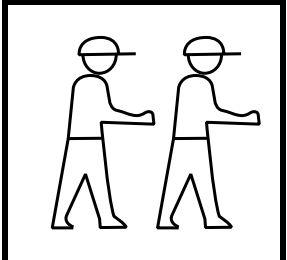
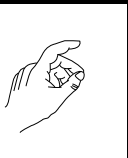
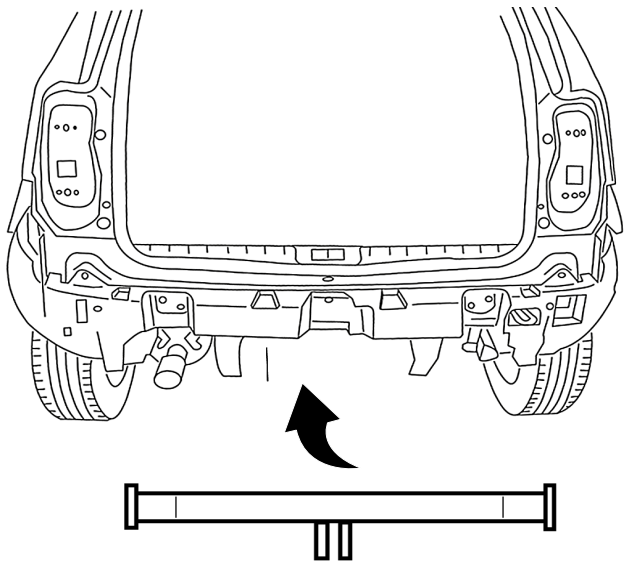

16

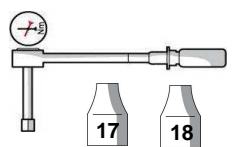
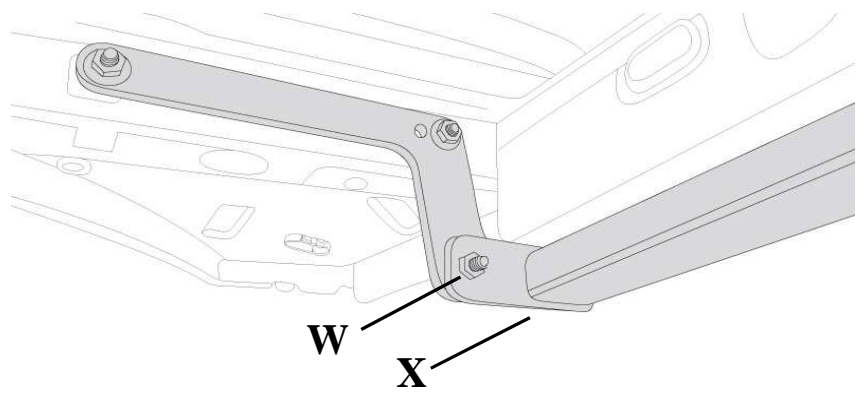
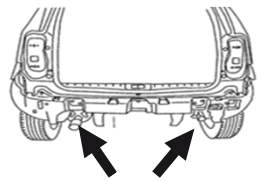

17

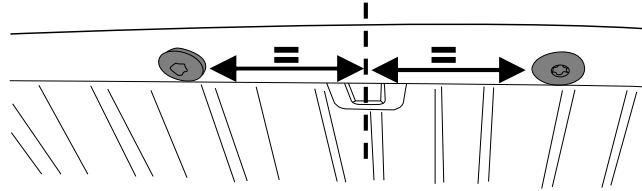
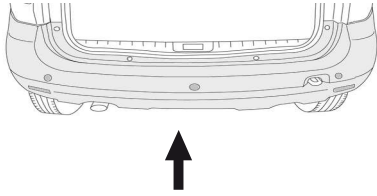

18

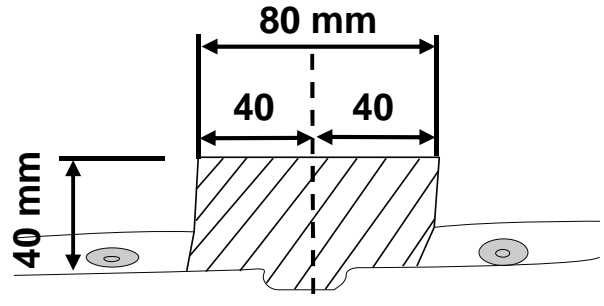
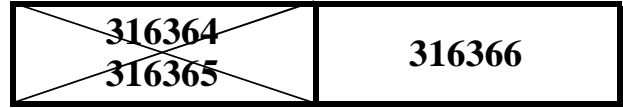
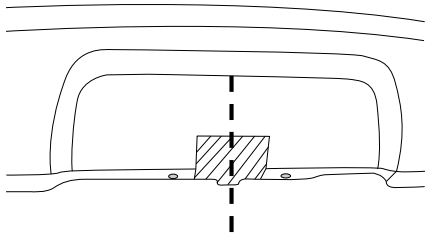

19

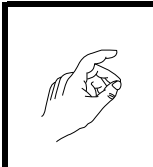
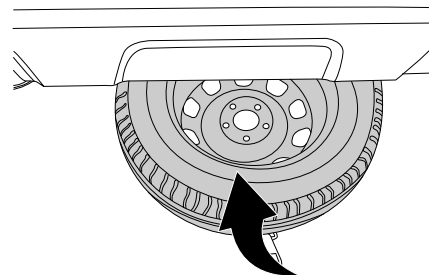
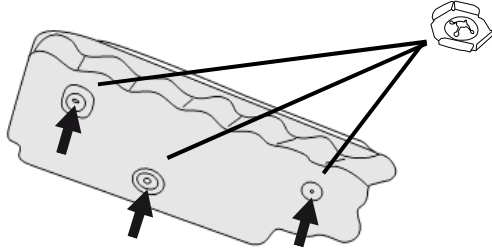
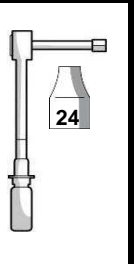
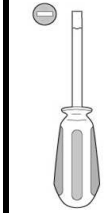
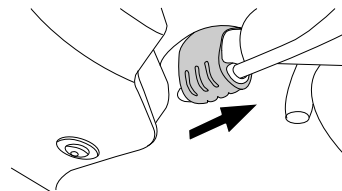
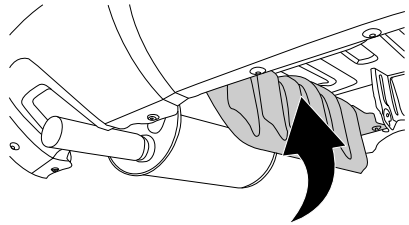

20

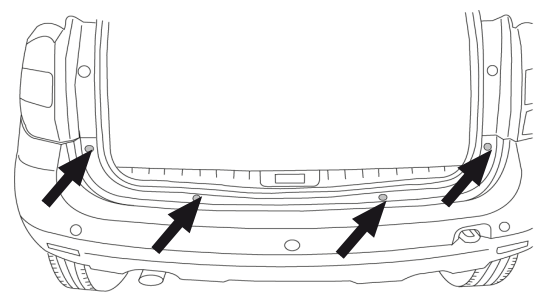
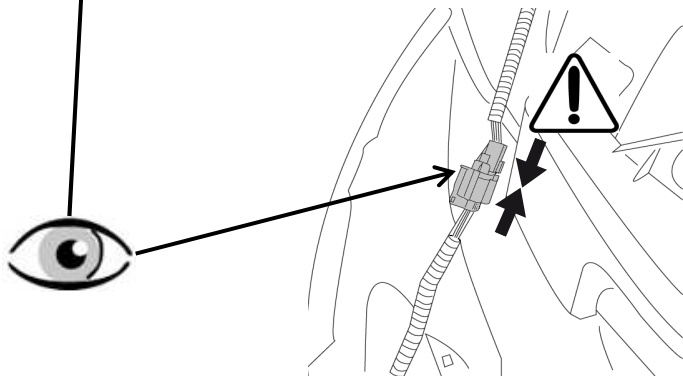
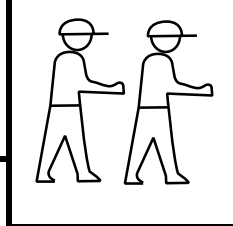
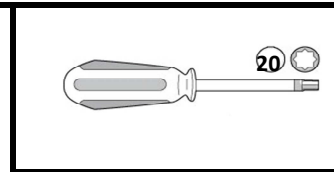
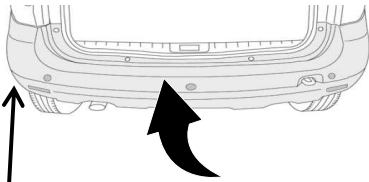

21

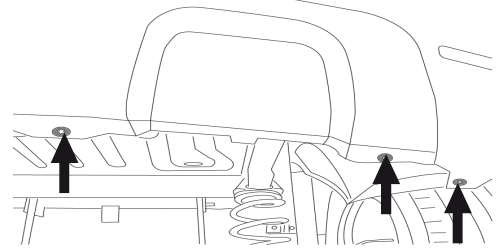
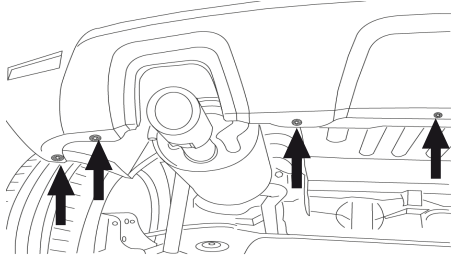
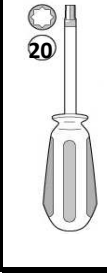
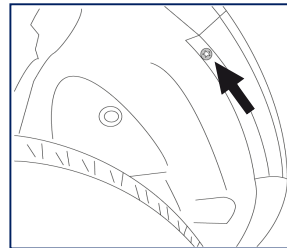
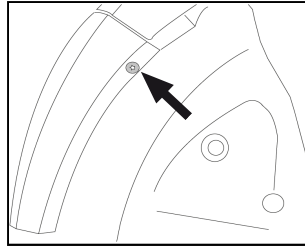
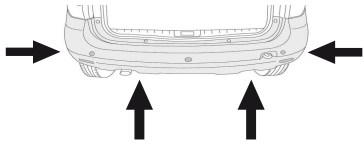

22

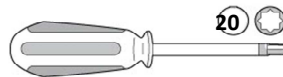
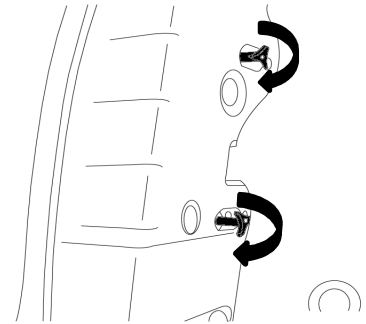
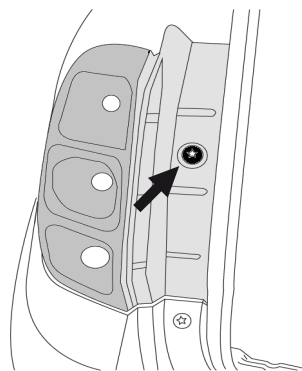
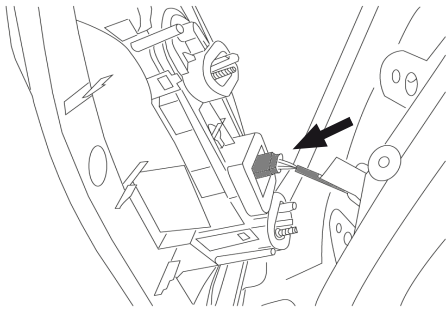
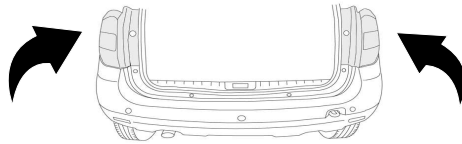

23

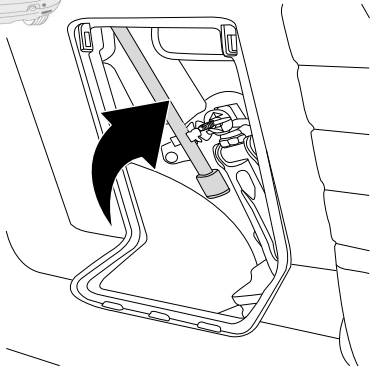
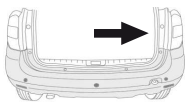

24

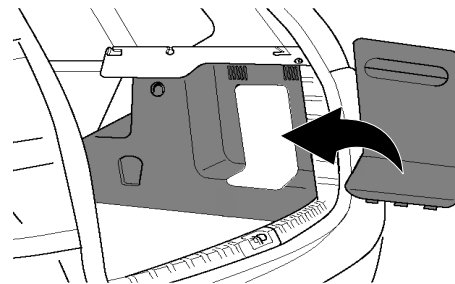
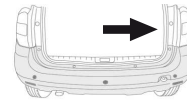

Dispositivo di traino tipo : **316364 / 316365 / 316366**
Per autoveicolo : **Dacia Duster**
Tipo funzionale : **SI216 / SI215**



Classe e tipo di attacco : **A50-X**
Omologazione : **e24*55R*01*0346 (316364 - 316365) - e24*55R*01*0345 (316366)**
Valore D : **8,62 kN**
Carico verticale max. S : **75 kg**
Massa rimorchiabile : vedi carta di circolazione dell'autoveicolo

In base alla Direttiva europea 94/20, la massa massima rimorchiabile del dispositivo di traino è determinata dal valore di prova "D" così definito :

$$D = (T \times C) / (T + C) \times 0,00981 = 8,62 \text{ kN}$$

dove : T = Massa complessiva max. della motrice (in kg) e C = Massa rimorchiabile max. della motrice (in kg)

DICHIARAZIONE DI CORRETTO MONTAGGIO :

la sottoscritta Ditta dichiara che il dispositivo di traino tipo _____ è stato installato a regola d'arte, nel rispetto dei punti d'attacco e delle prescrizioni fornite dalla Casa costruttrice

sul veicolo Berlingo/Partner

targato _____

li _____

Si dichiara inoltre di aver informato l'utente del veicolo sull'USO e MANUTENZIONE del dispositivo stesso.

timbro et firma