

Fitting instructions

Make: Toyota

Urban Cruiser

Type: 5080

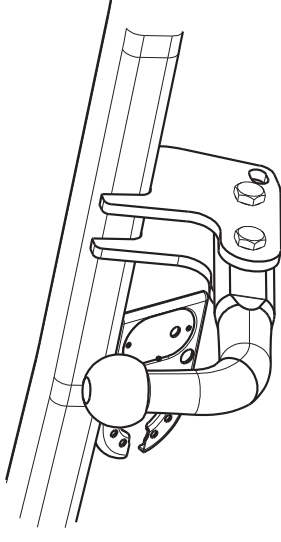
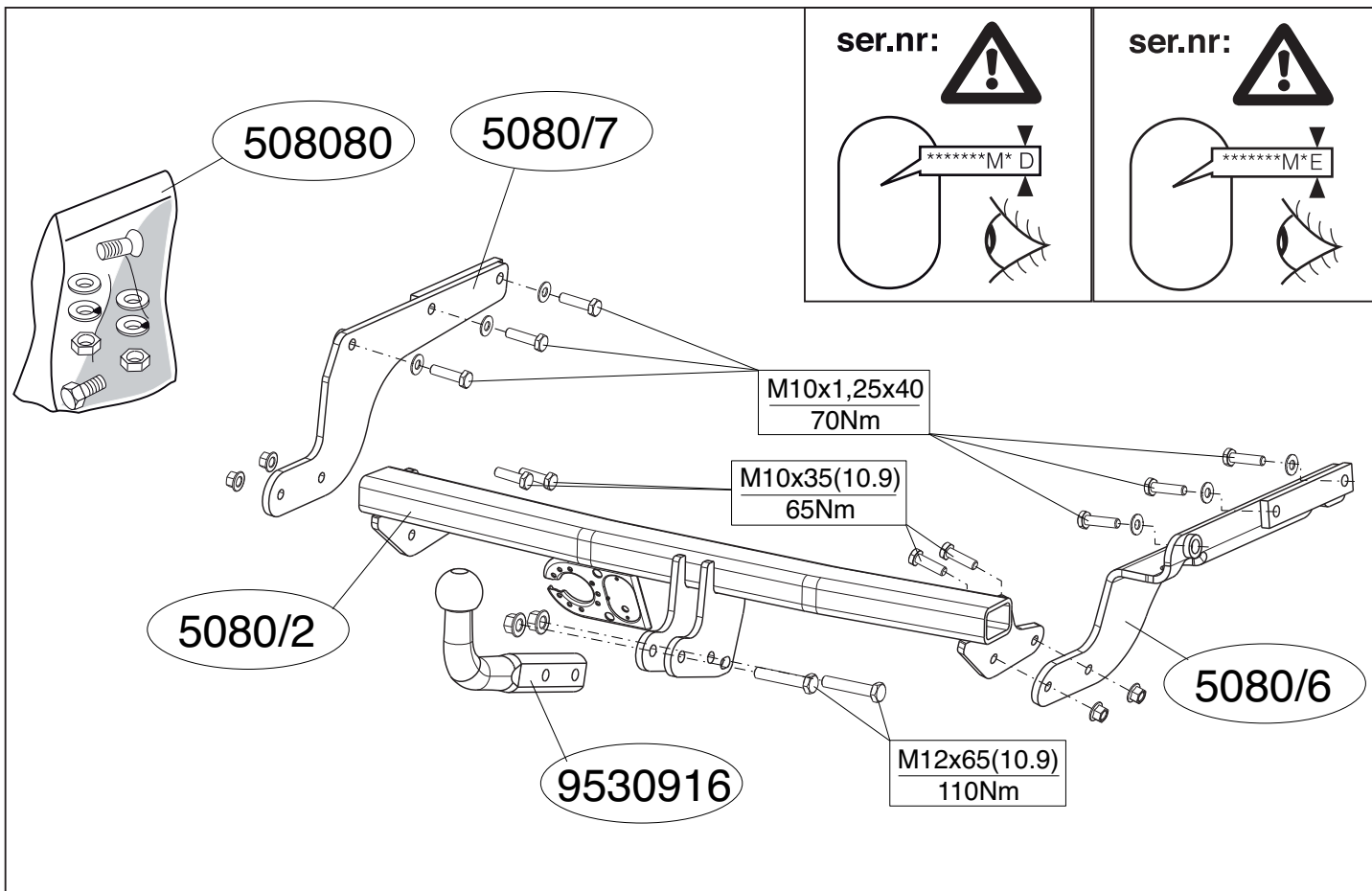



© 508070/28-04-2010/1



Dispositivo di traino tipo: 5080
 Per autoveicoli: URBAN CRUISER; 2009->
 Tipo funzionale: NLP115 * - AHF * * W

Classe e tipo di attacco: A50-X
 Omologazione: e11 00-7081
 Valore D: 6.1 kN
 Carico Verticale max. S: 50 kg
 Larghezza rimorchiabile per Caravan e T.A.T.S.: 2,45m vedere CARTA di CIRCOLAZIONE VEICOLO (motrice) + 70 cm = ..arrotondare ai 5 cm superiore (vedi D.M.28/05/85)
 Massa rimorchiabile: vedi carta di circolazione dell' autoveicolo

Per verificare l'idoneità del dispositivo di traino omologato a norma CEE 94/20, all'installazione sulla vettura su cui si intende procedere al montaggio, compilare la seguente formula (se necessario declassare la massa rimorchiabile):

$$D = \frac{T \times C}{T + C} \times 0,00981 \leq 6,1 \text{ kN}$$

dove: T= Massa Complessiva Max. della motrice (in kg)
 C= Massa Rimorchiabile Max. della motrice (in kg)

DA COMPILARE PER IL COLLAUDO

DICHIARAZIONE DI CORRETTO MONTAGGIO: la sottoscritta Ditta dichiara di aver montato in maniera corretta ed in conformità alle prescrizioni sia del costruttore del veicolo che del costruttore del dispositivo stesso il seguente dispositivo di attacco meccanico:

tipo:.....
 Il dispositivo di attacco sopra indicato è stato installato su autoveicolo
 modello:.....
 targa:.....
 Data:.....





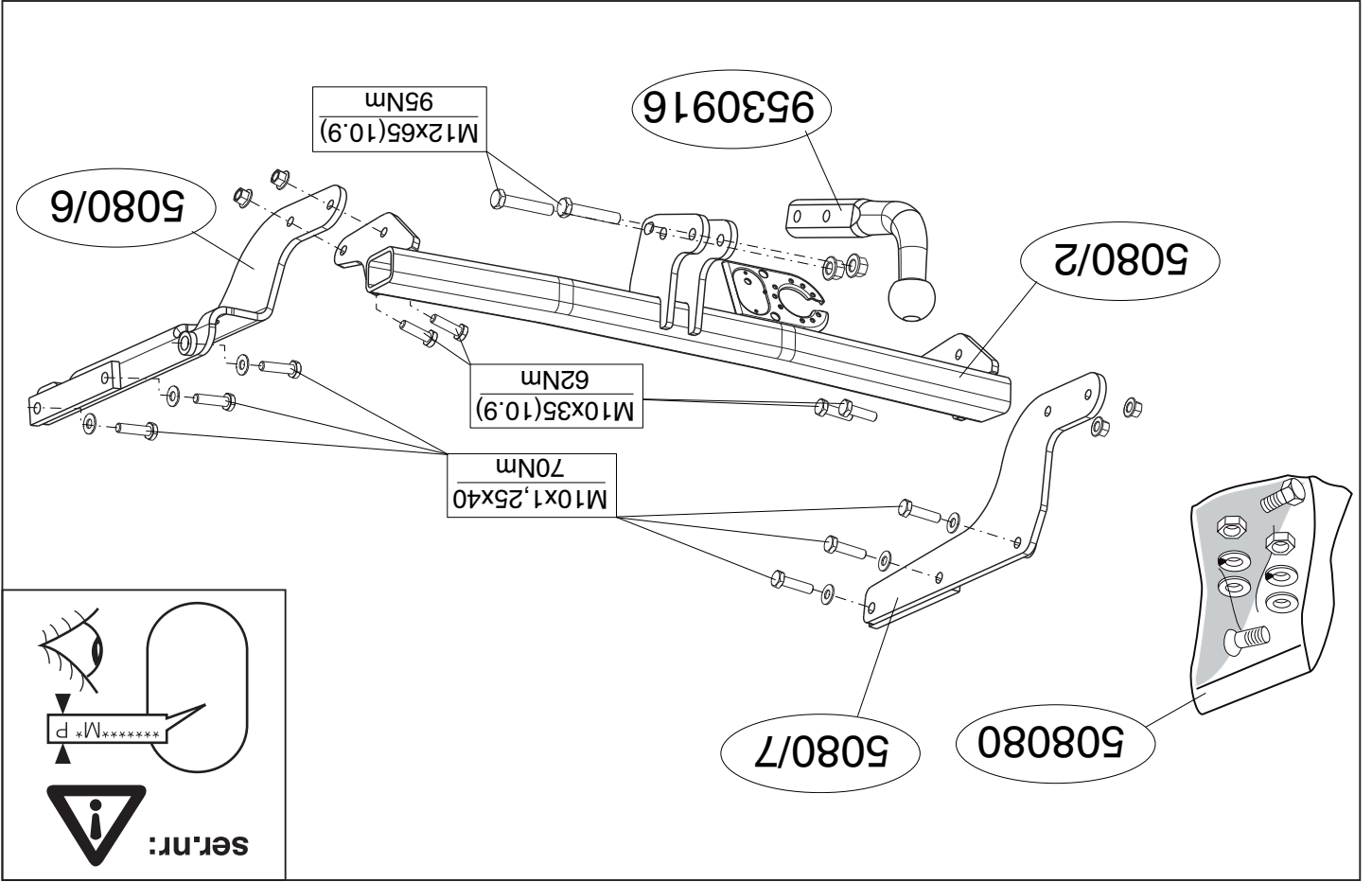

TIMBRO e FIRMA

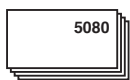
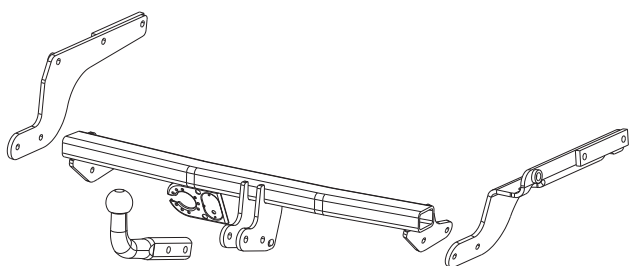
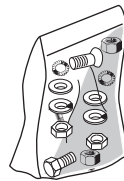
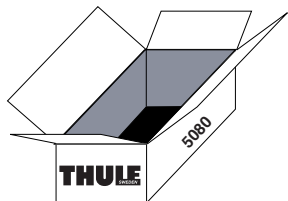
Si dichiara inoltre di aver informato l'utente del veicolo sull'USO e MANUTENZIONE del dispositivo stesso.

© 508070/28-04-2010/18





-  (6x) M10x1,25x40
-  (6x) M10
-  (4x) M10x35 (10.9)
-  (4x) M10 (10)
-  (2x) M12x65(10.9)
-  (2x) M12 (10)

© 508070/28-04-2010/3

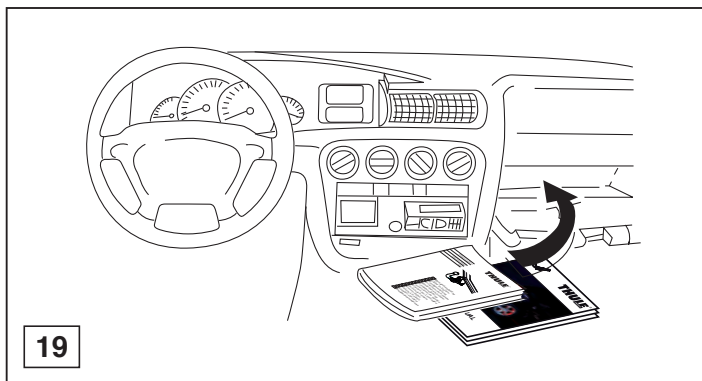

© 508070/28-04-2010/16

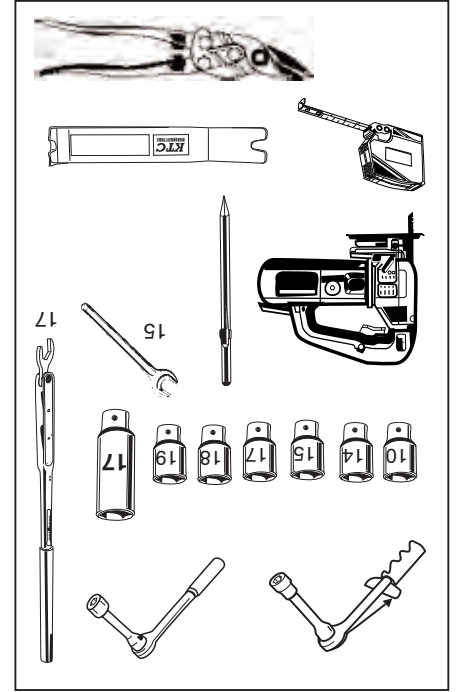
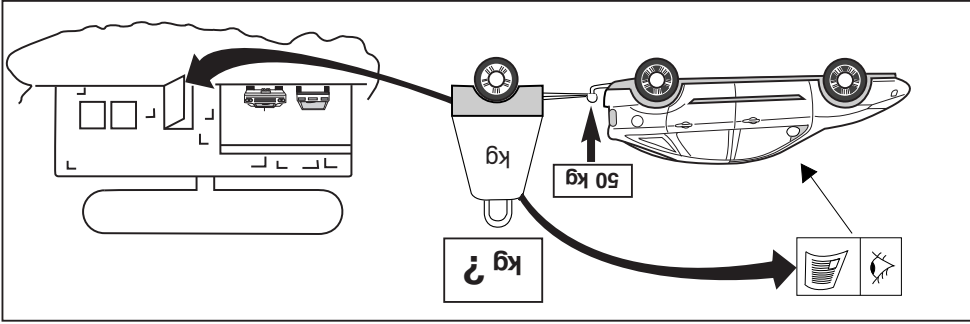
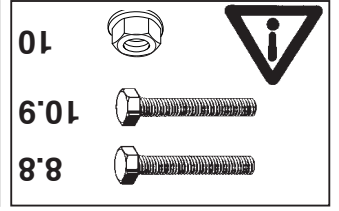
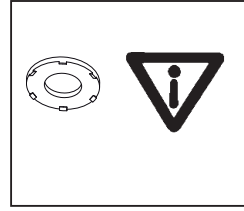
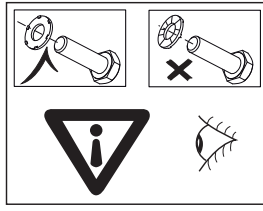
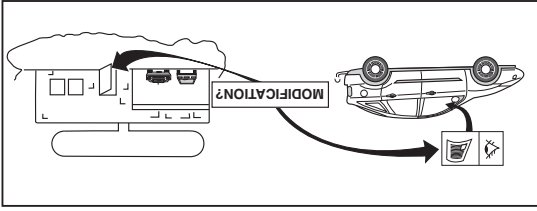

D-Value : 6,1 kN

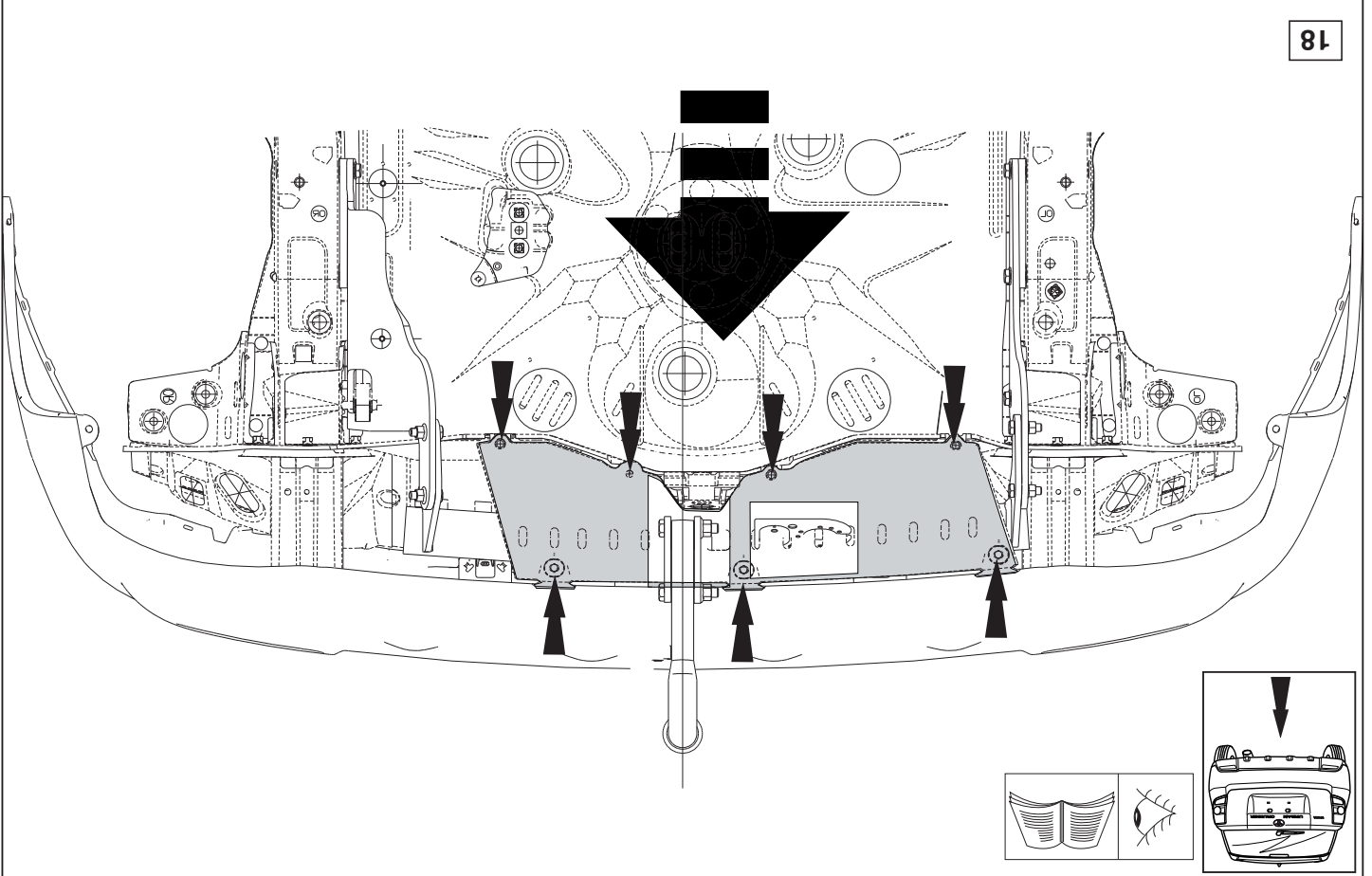
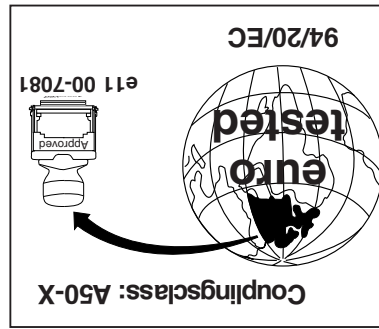



NOTE:

* Should this installation process entail the cutting of the bumper – confirmation **MUST** be obtained by the installation engineer of the customer's acceptance prior to completion. Thule Towing Systems do not accept responsibility for any matters arising as a result of this miscommunication.

All measurements are in mm!

HINWEISE:

* Die für das Fahrzeug zugelassene Anhängelast ist den Fahrzeug Unterlagen zu entnehmen. Bei Änderungen des Fahrzeuggewichtes muß die höchstzulässige Anhängelast gegebenenfalls aus dem D-Wert nachgerechnet werden.

Auskunft hierüber kann Ihr Fachhändler oder der TÜV geben.

* Elektrische Anlage gemäß StVZO anbringen.

© 508070/28-04-2010/5

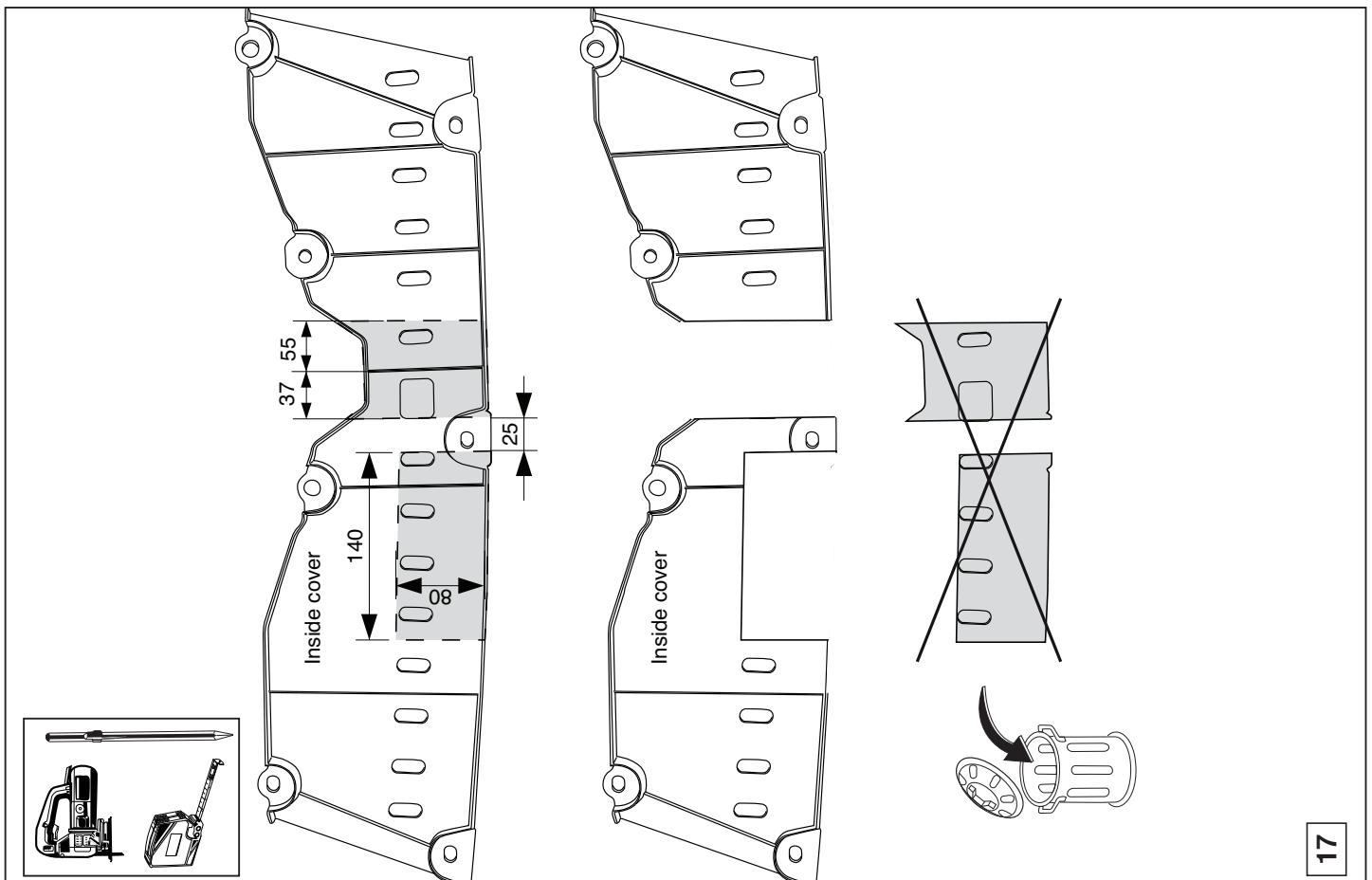

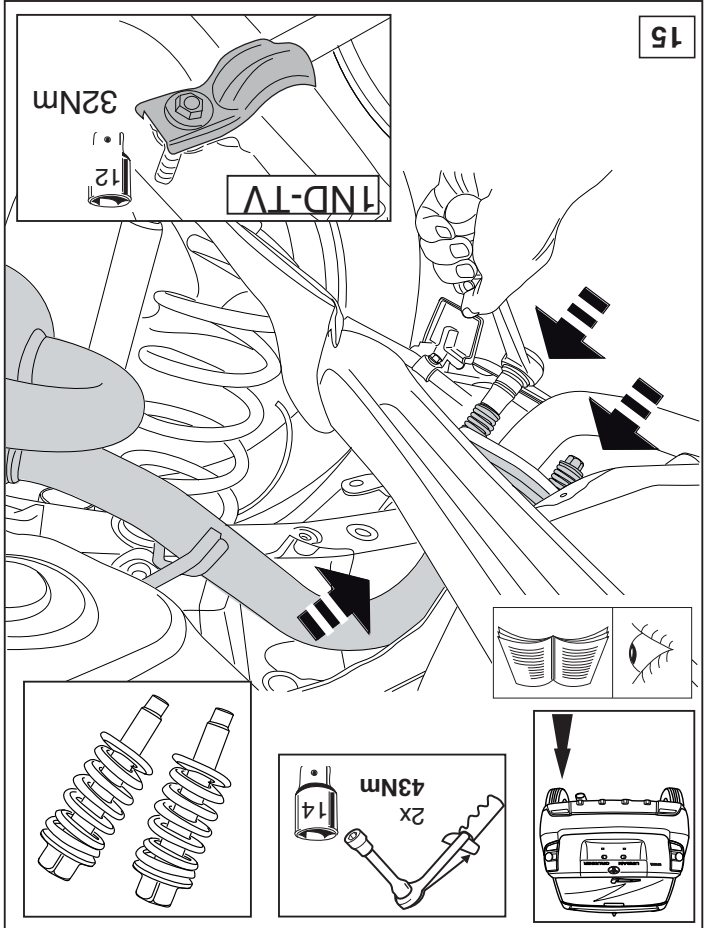
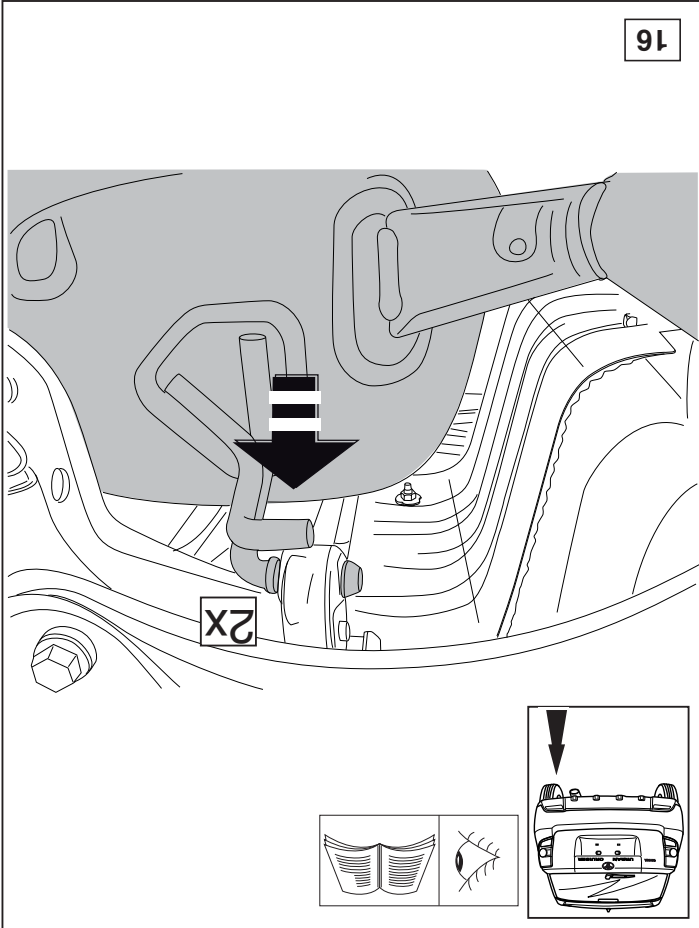
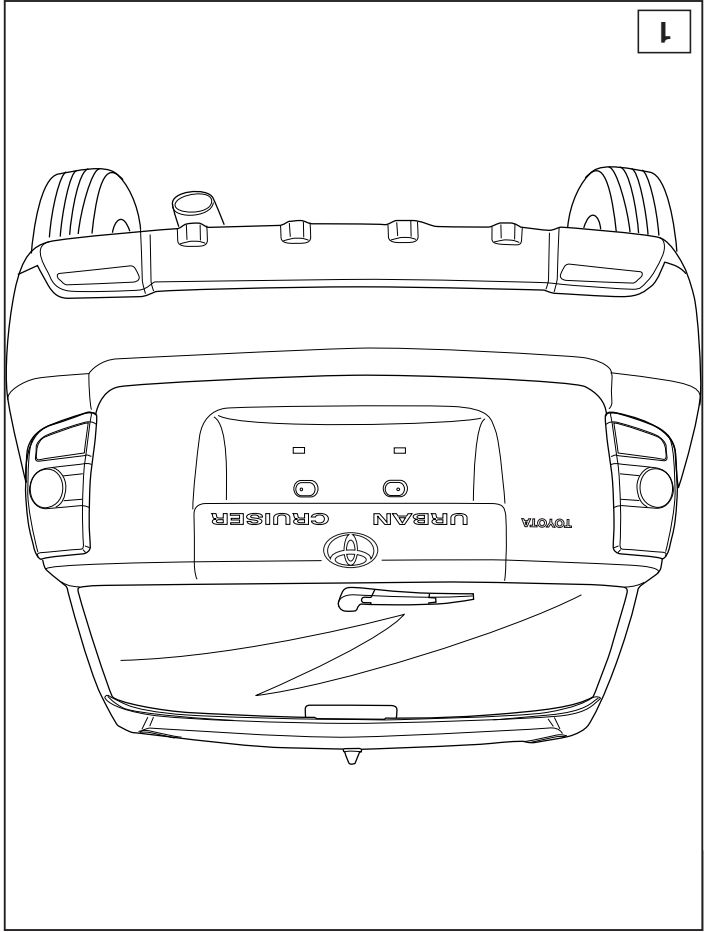
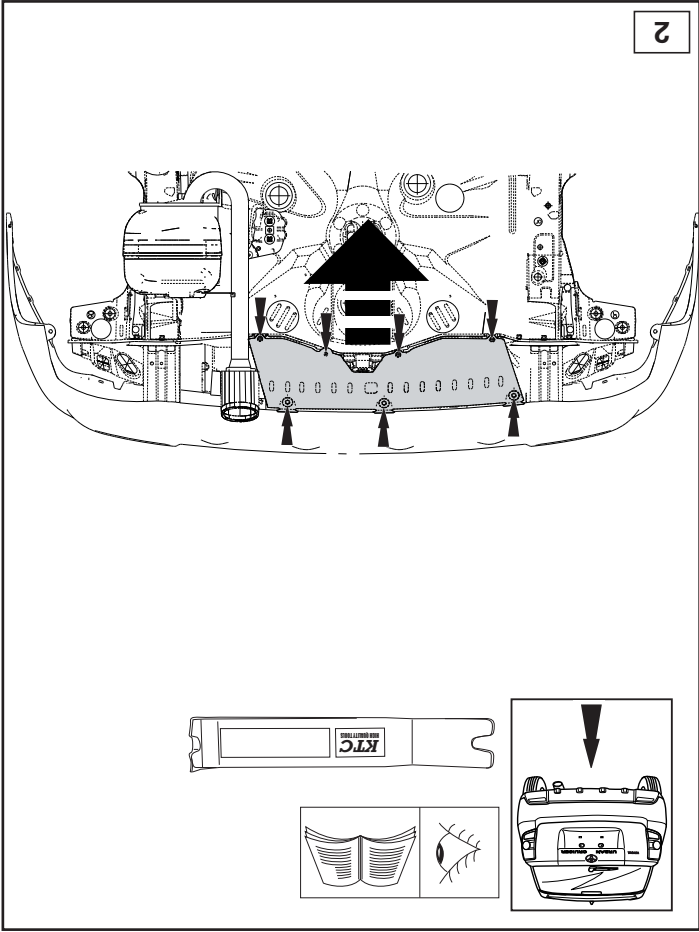

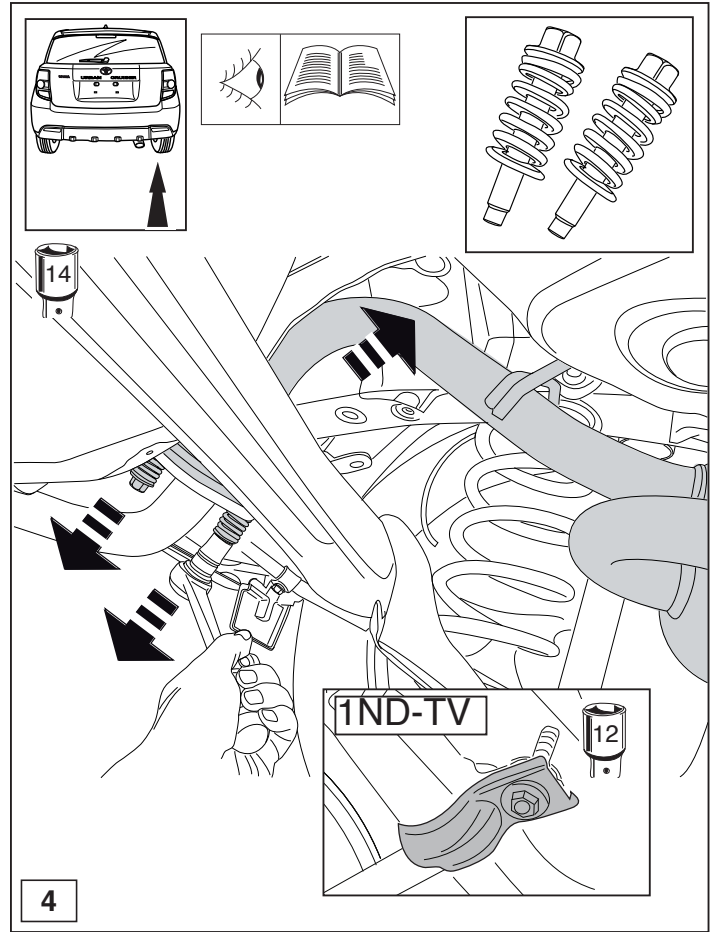
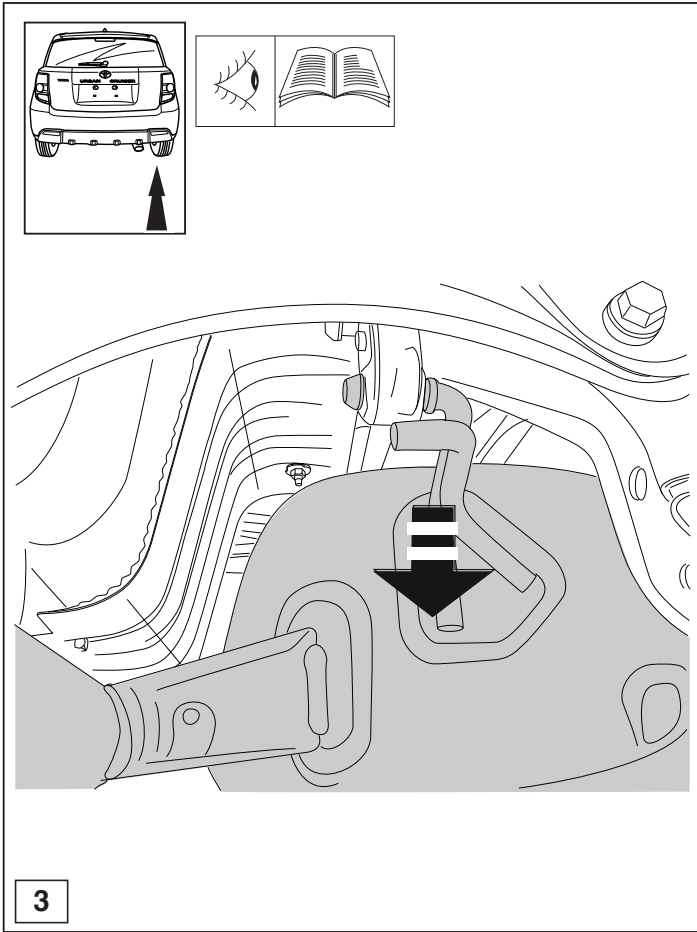

© 508070/28-04-2010/7

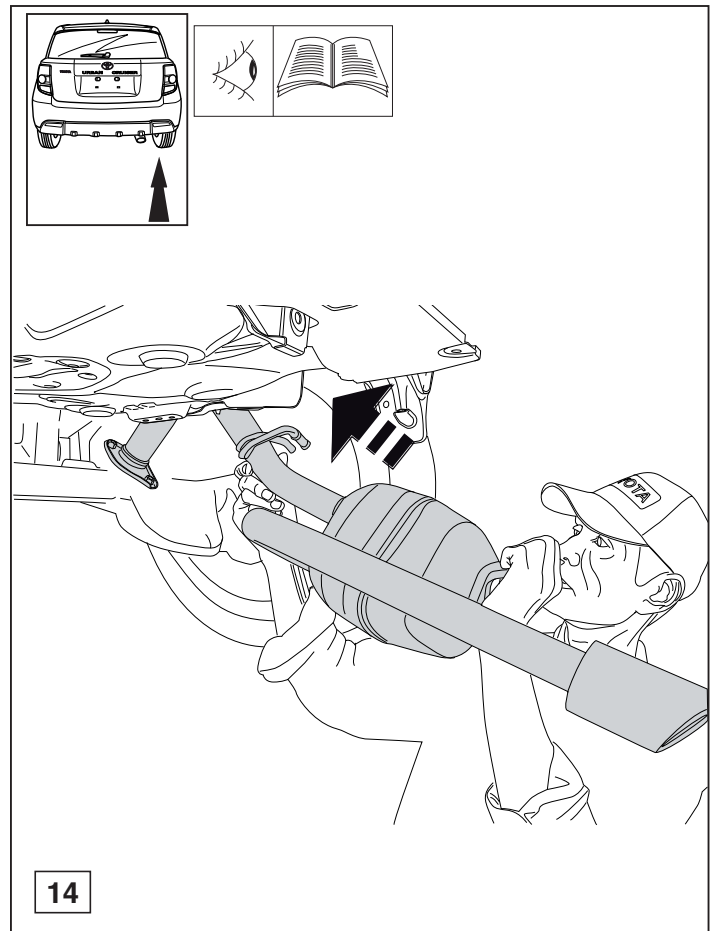
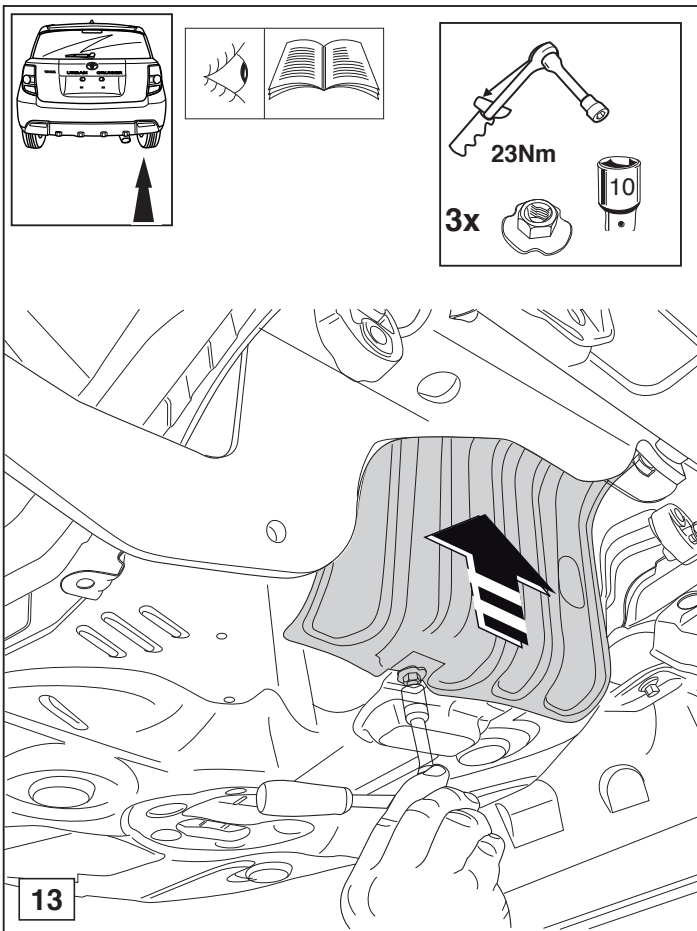

© 508070/28-04-2010/12

