

# Wiringkit

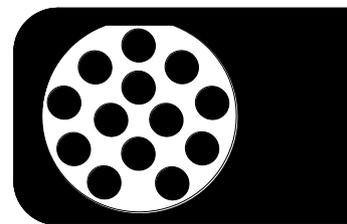

D	Einbauanleitung
GB	Installation instructions
F	Consignes de montage
NL	Montagehandleiding
DK	Montagevejledning
N	Monteringsinstruksjon
S	Installationsanvisning
FIN	Asennusohje
I	Istruzioni per il montaggio
E	Instrucciones de montaje
P	Instruções de montagem
GR	Οδηγίες εγκατάστασης
CZ	Návod k montáži
SLO	Navodilo za vgradnjo
SK	Montážny návod
PL	Instrukcja montażu
TR	Montaj talimatı
H	Beépítési útmutató
HR	Upute o ugradnji
BUL	Инструкция за монтаж
RO	Instrucțiuni de montaj
RU	Инструкция по монтажу и установке
LT	Montavimo informacija
LV	Iemontēšanas pamācība
EST	Paigaldusjuhend

## 709544

FIAT

- **Tipo Sedan** 02/16>>
- **Tipo Hatchback** 06/16>>
- **Tipo Combi** 06/16>>

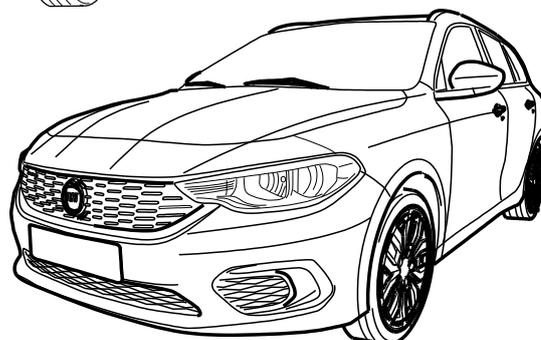
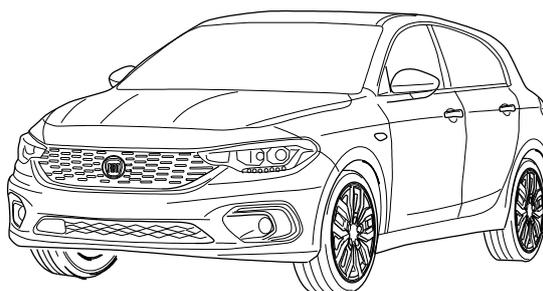
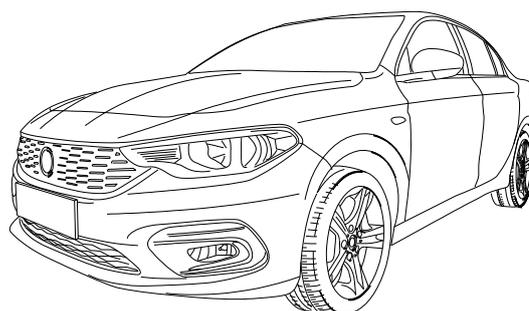



# OVERVIEW

# Hatchback, Combi

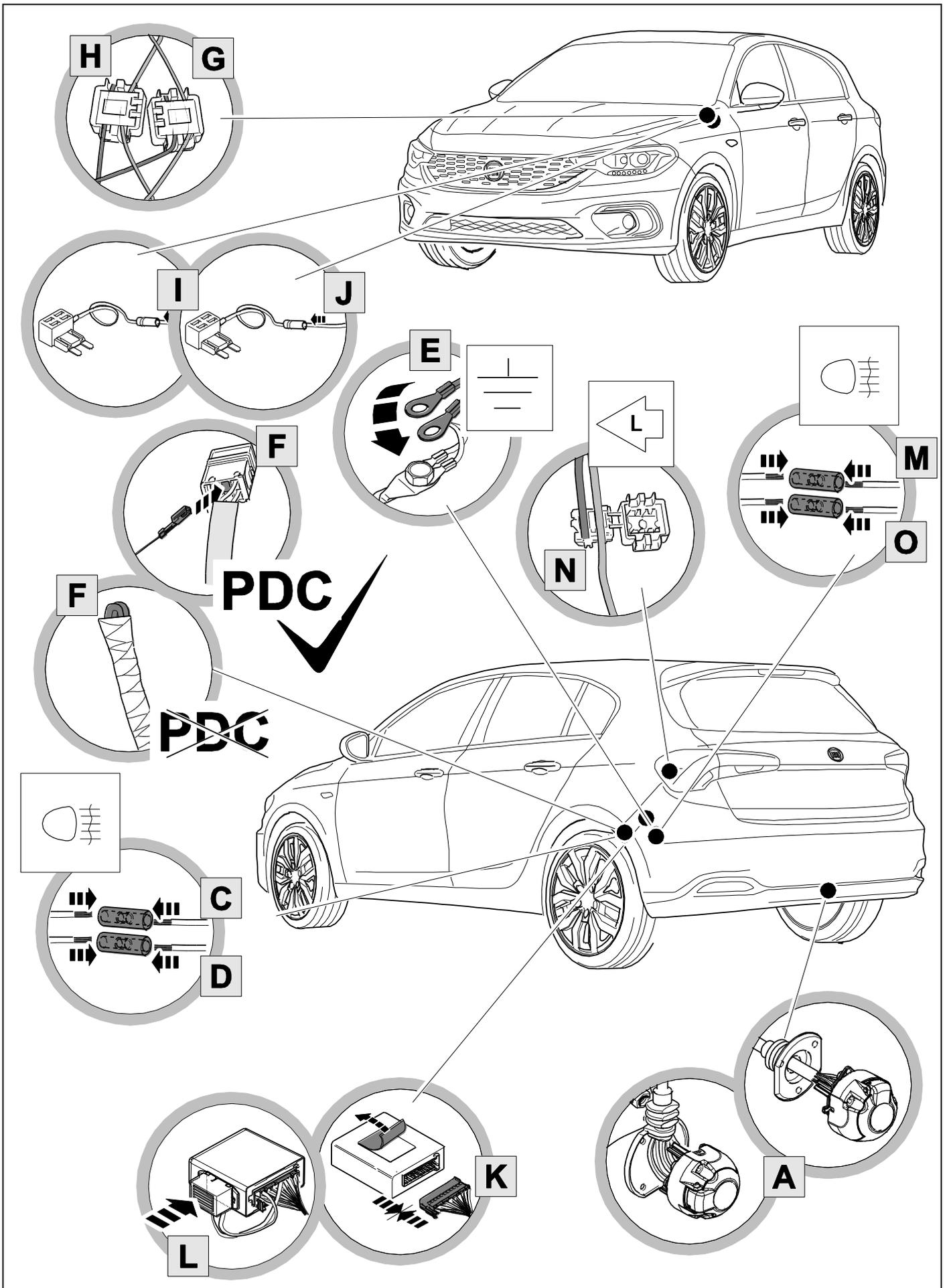

# KIT

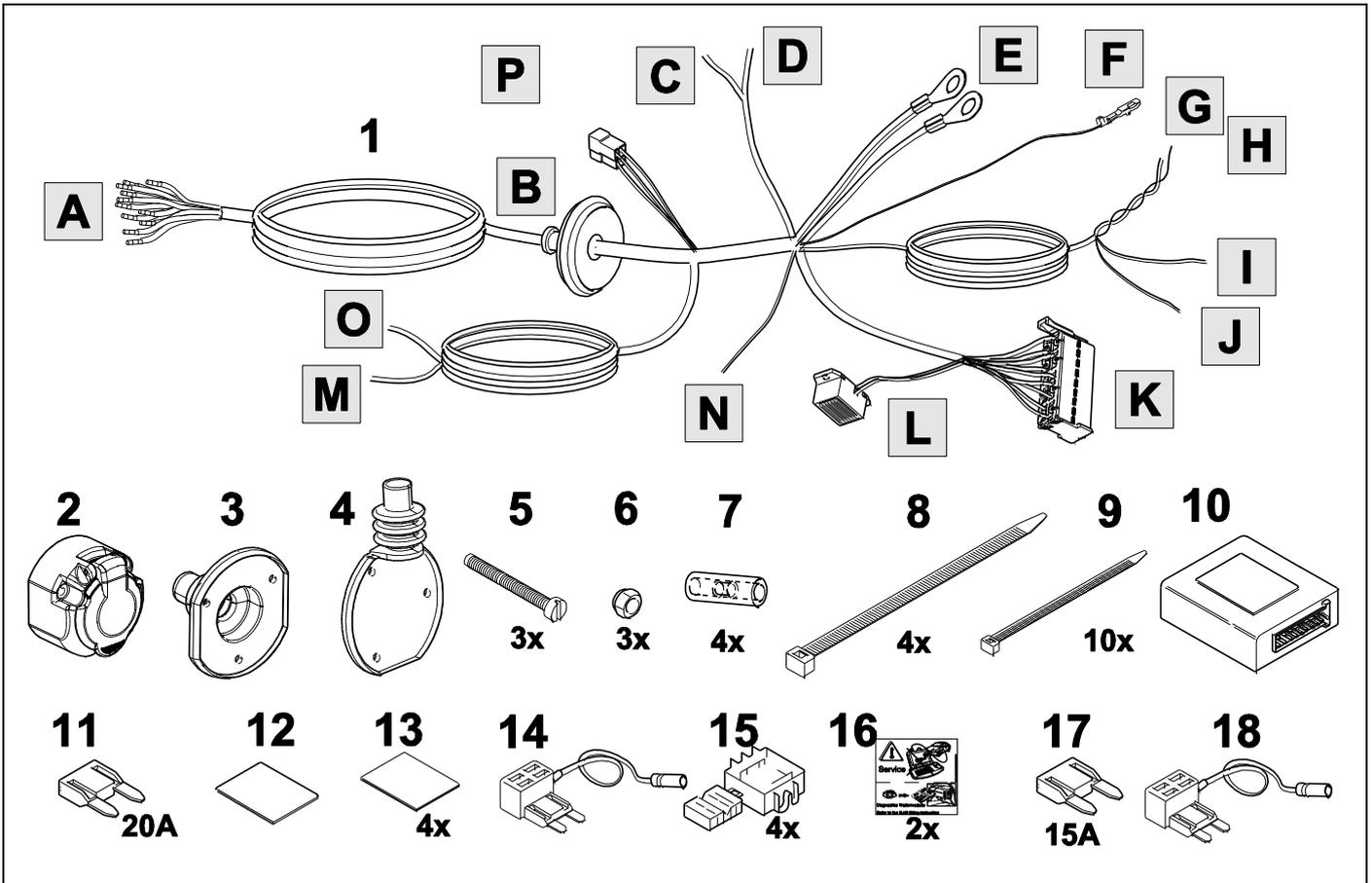

# TOOLS

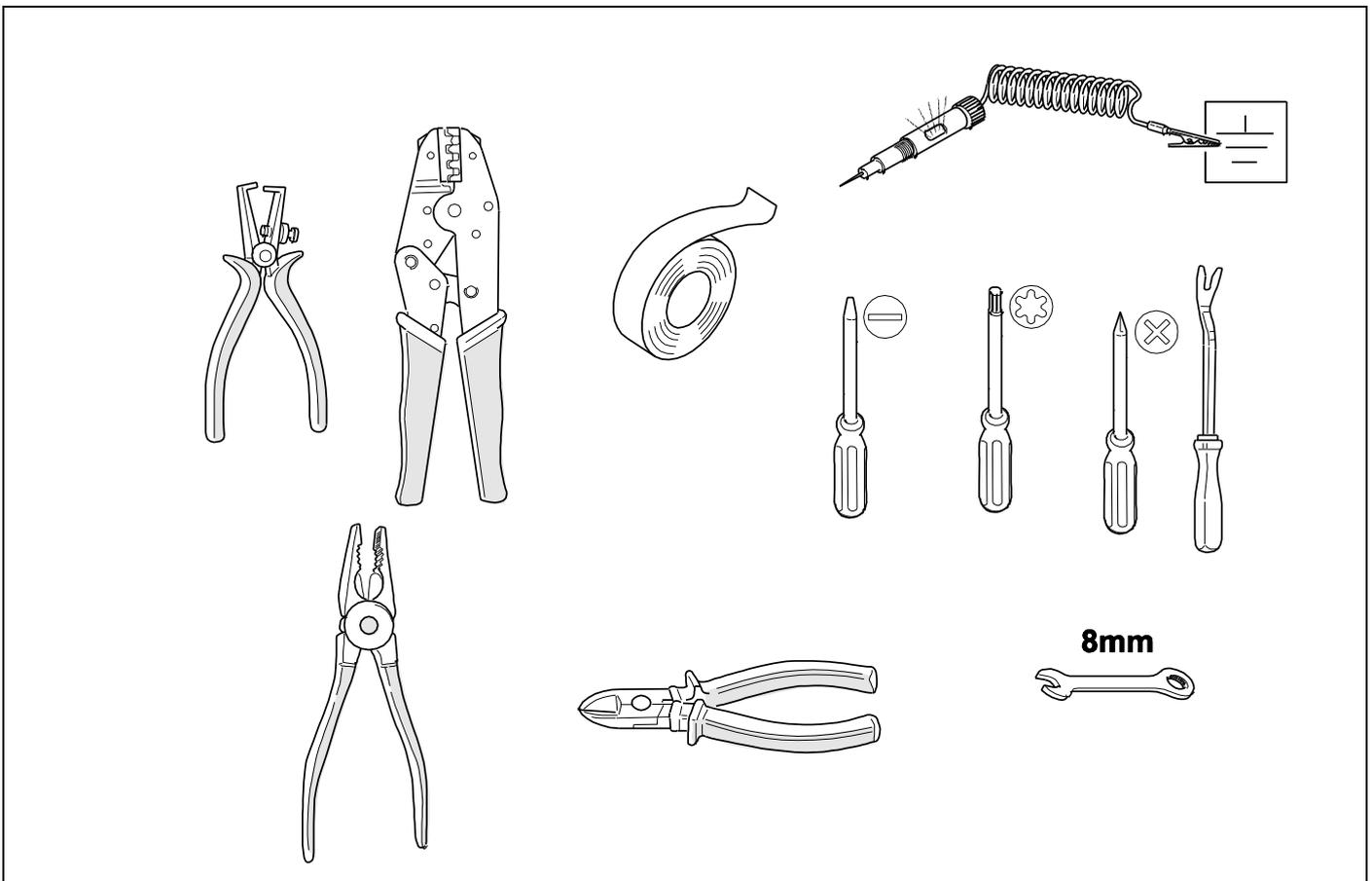

1

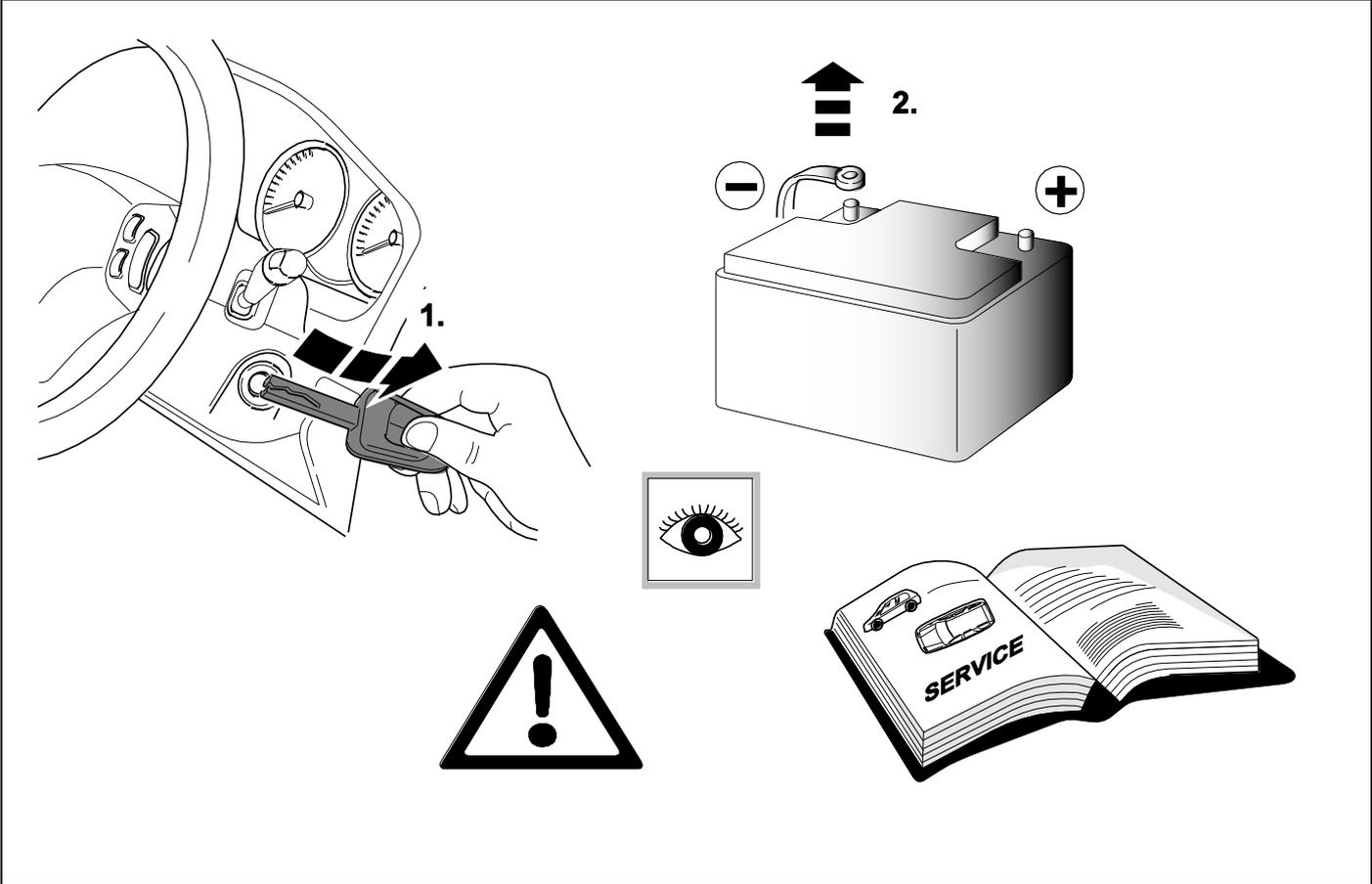

# 2 REMOVE

## Sedan

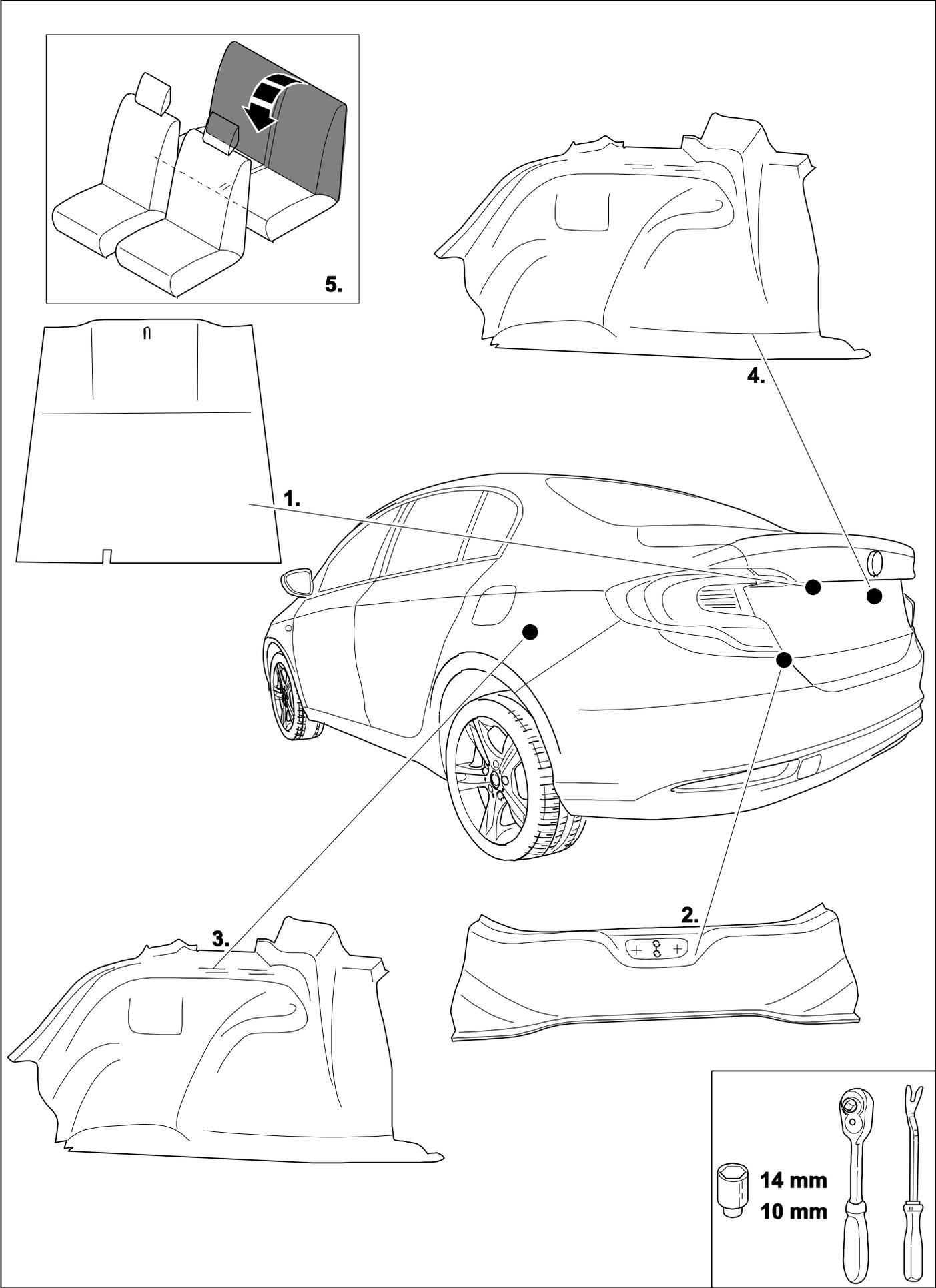

### 3 REMOVE

### Hatchback

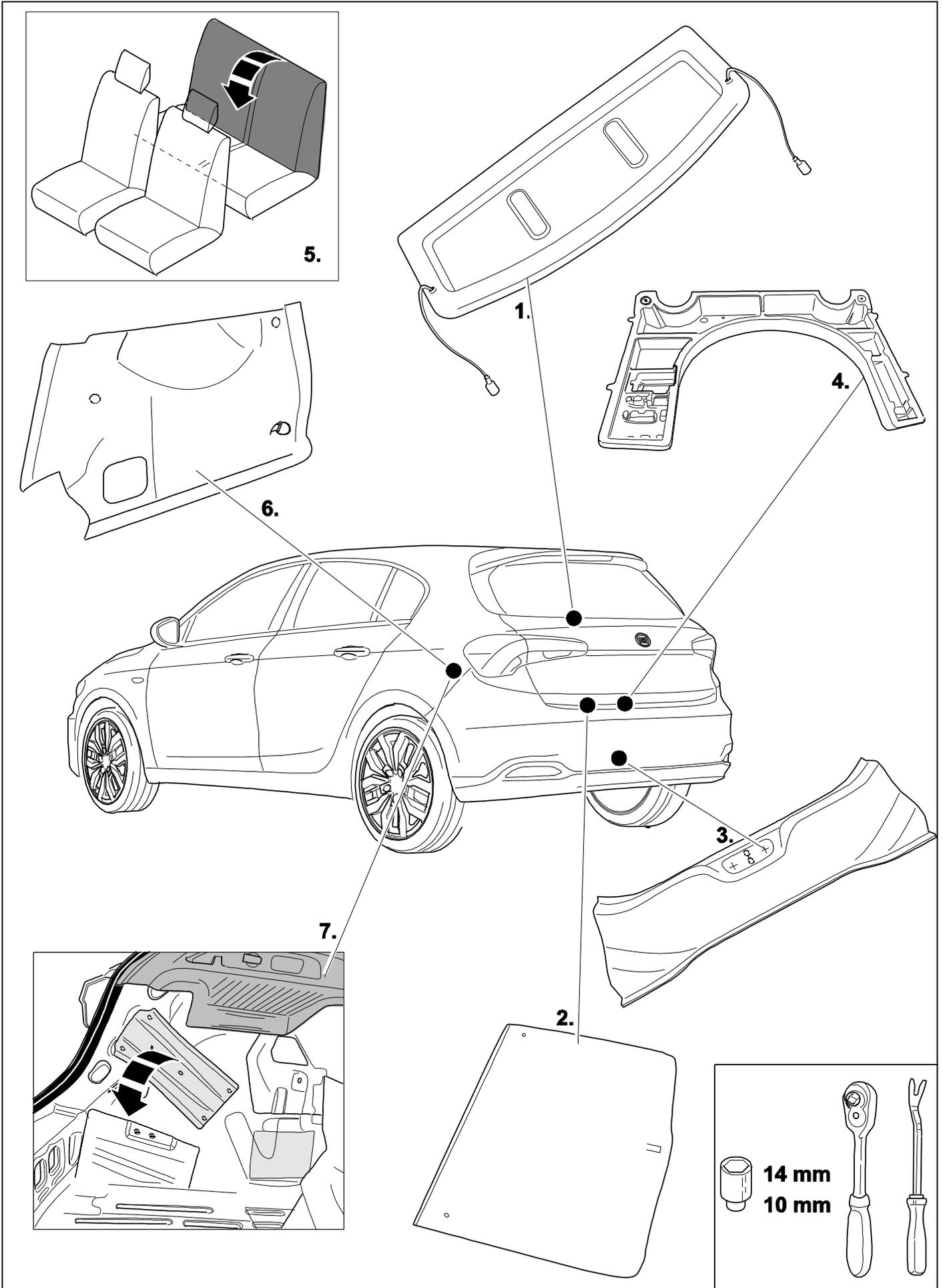

# 4 REMOVE

# Combi

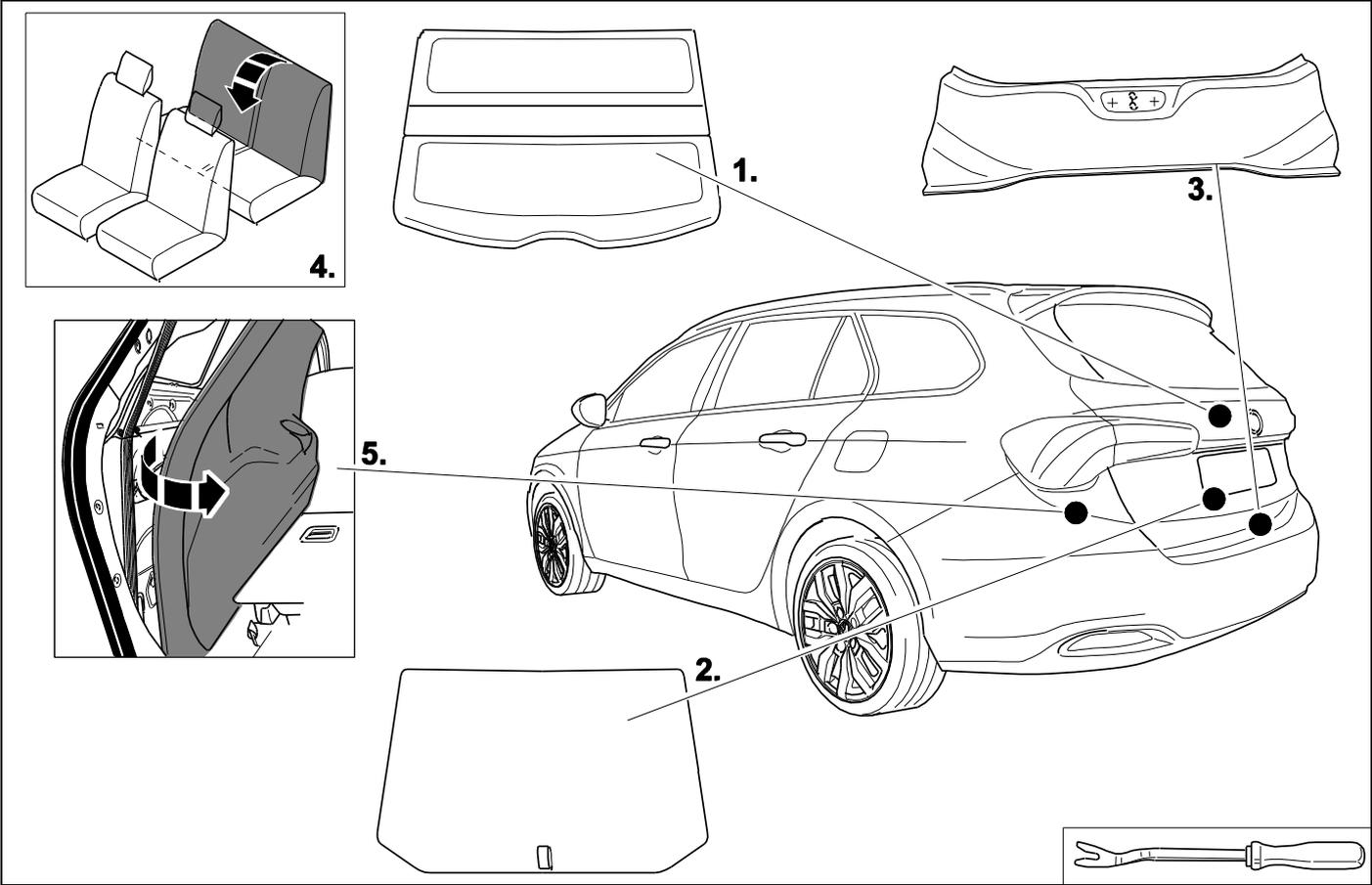



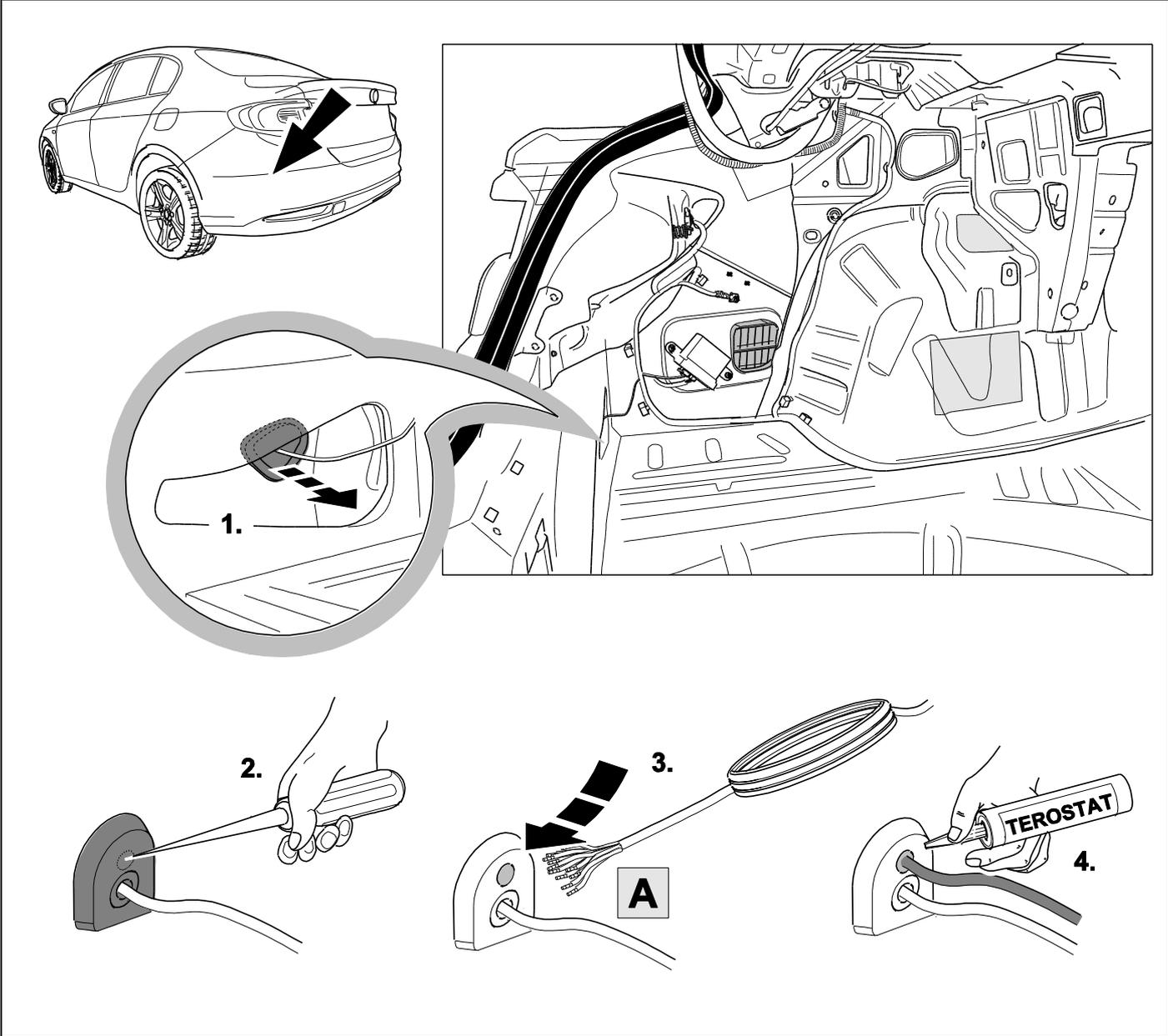

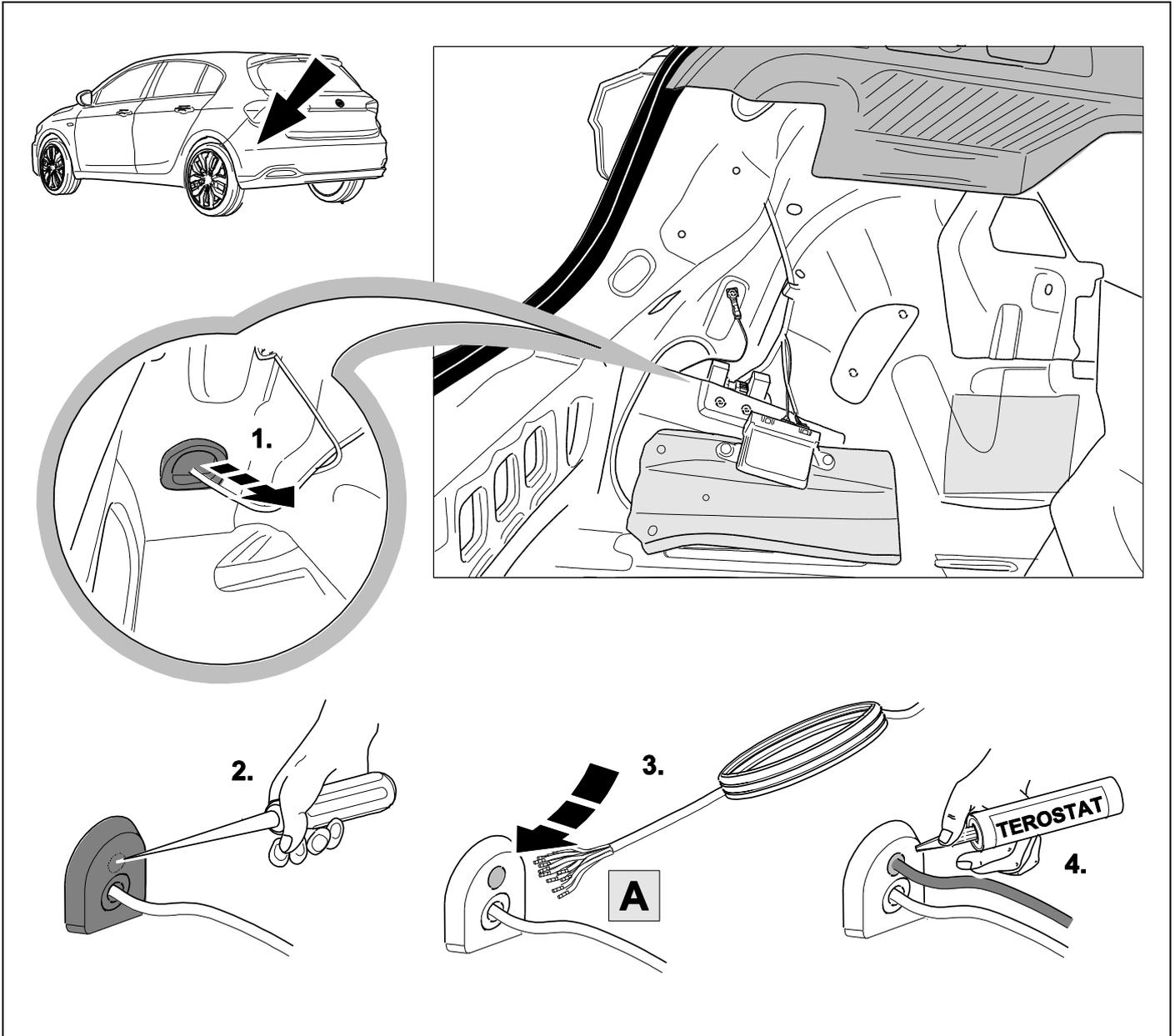

7

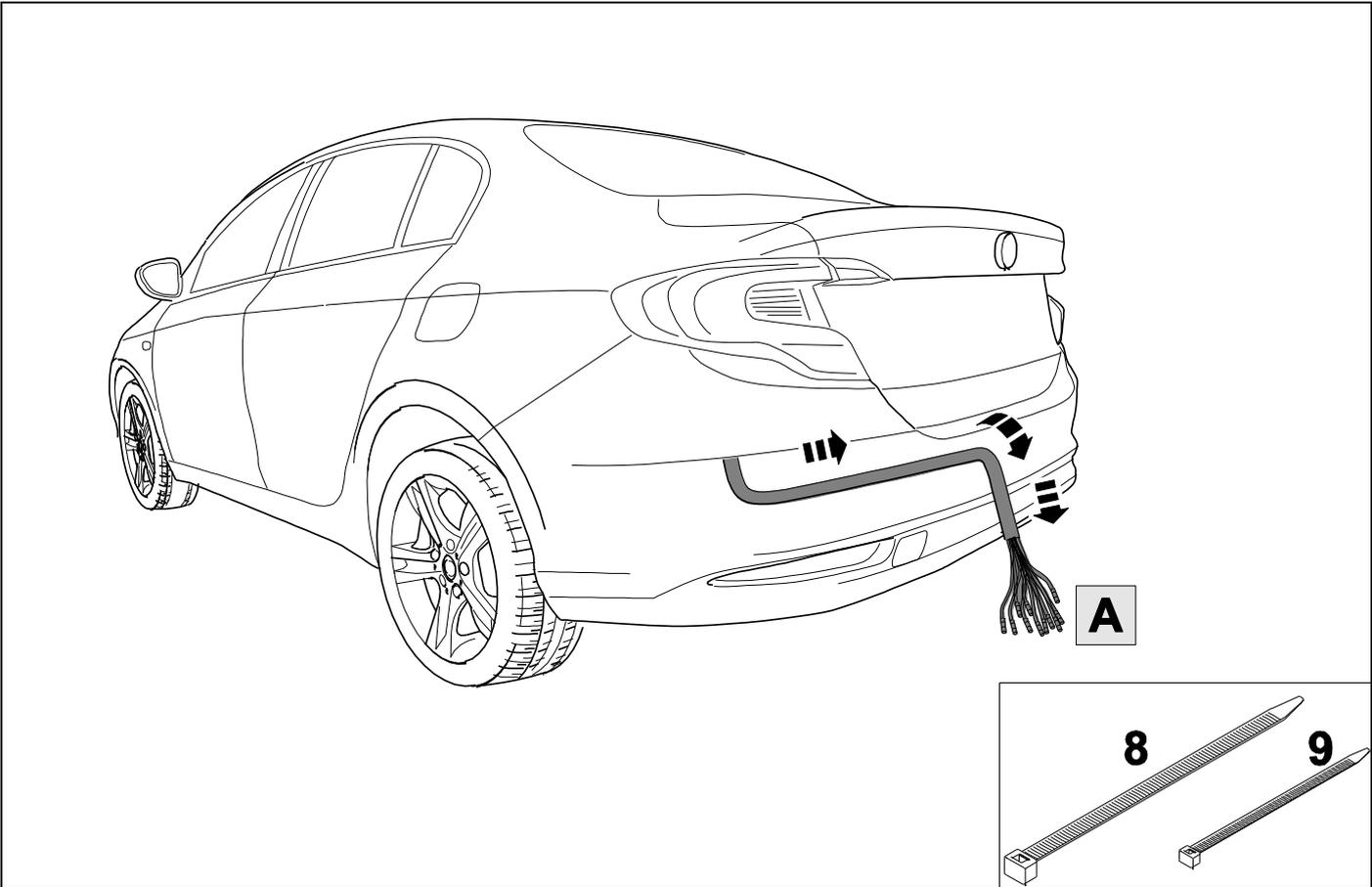

8

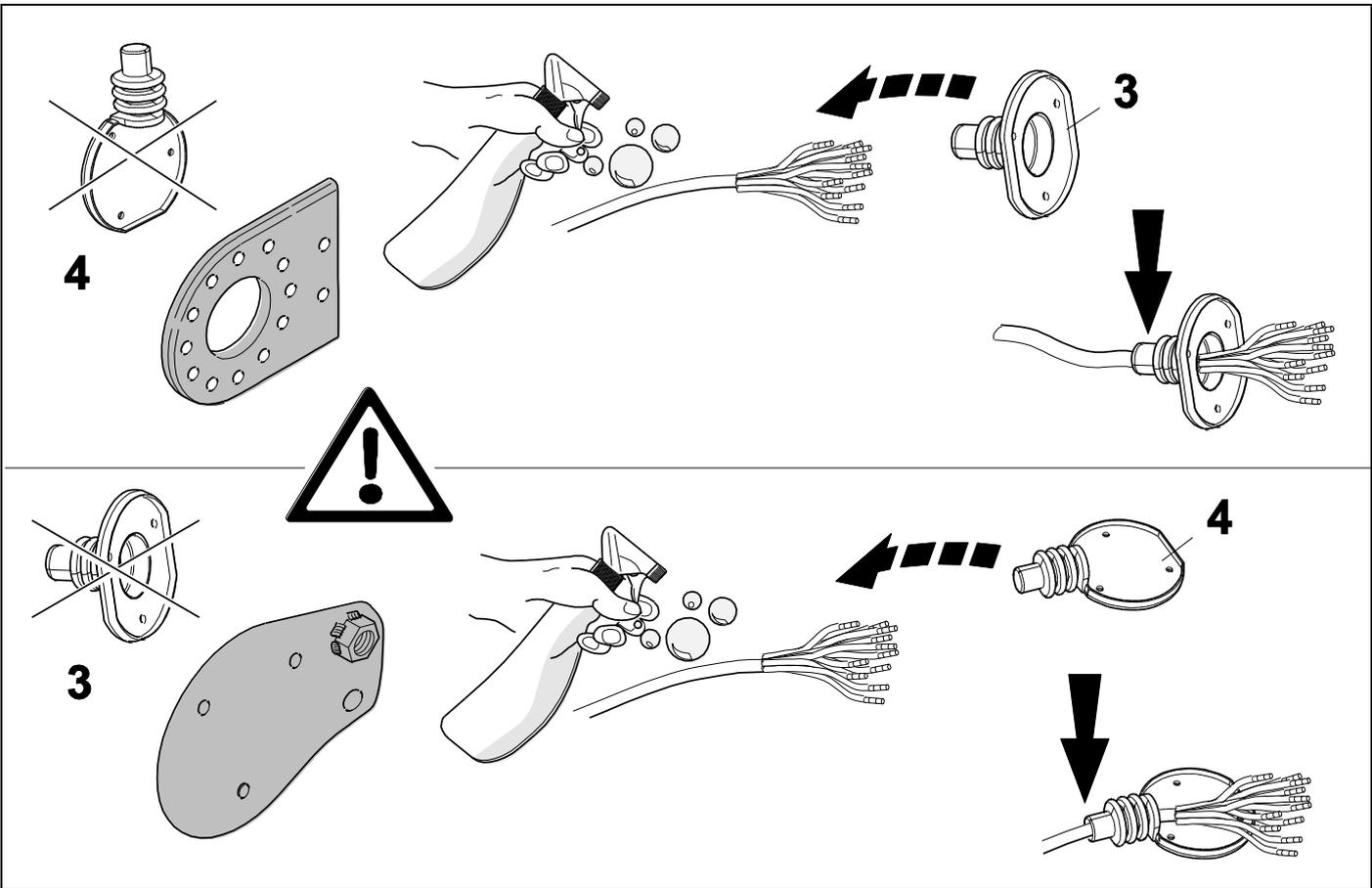

9



11

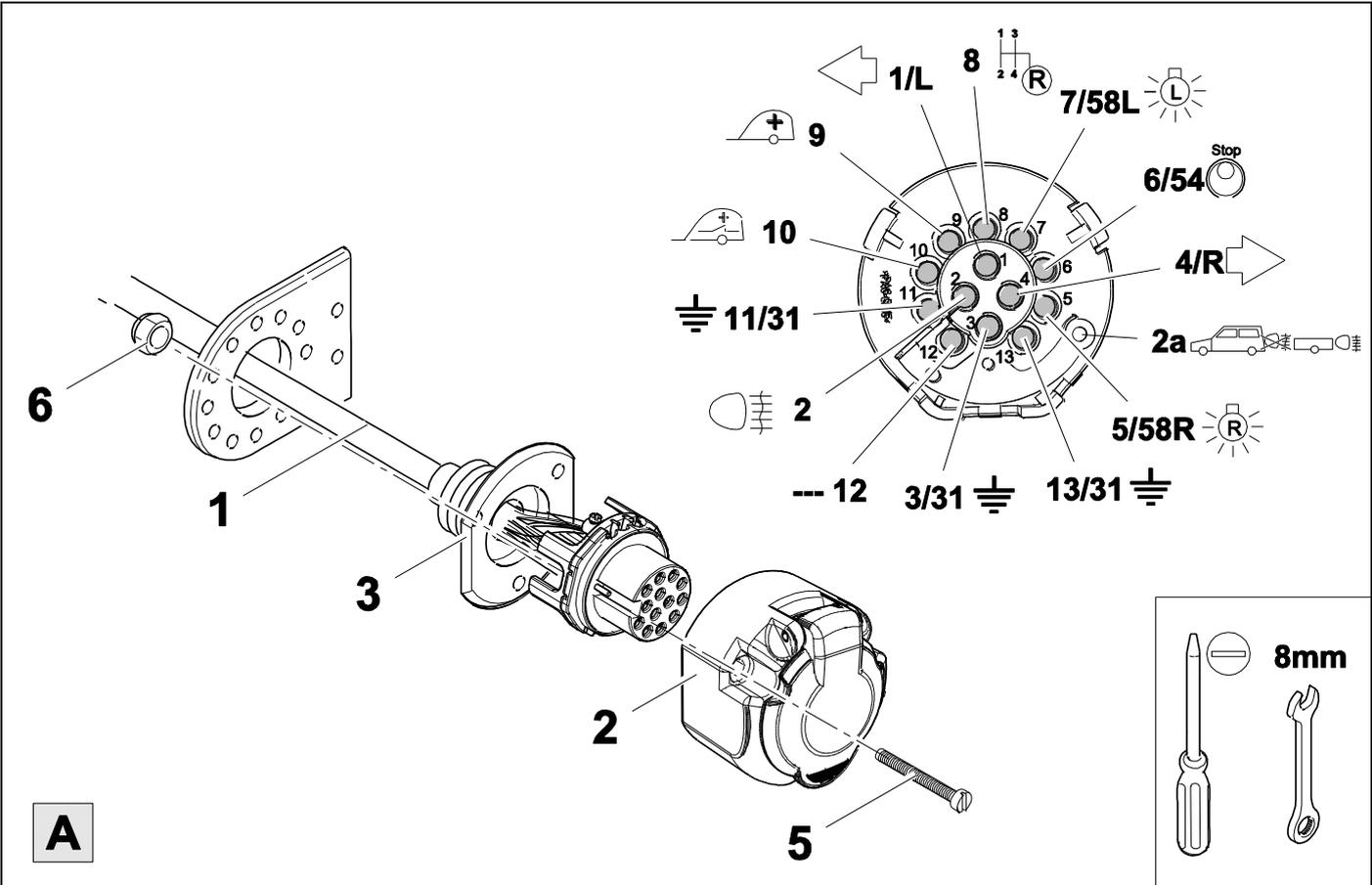

A

10



11

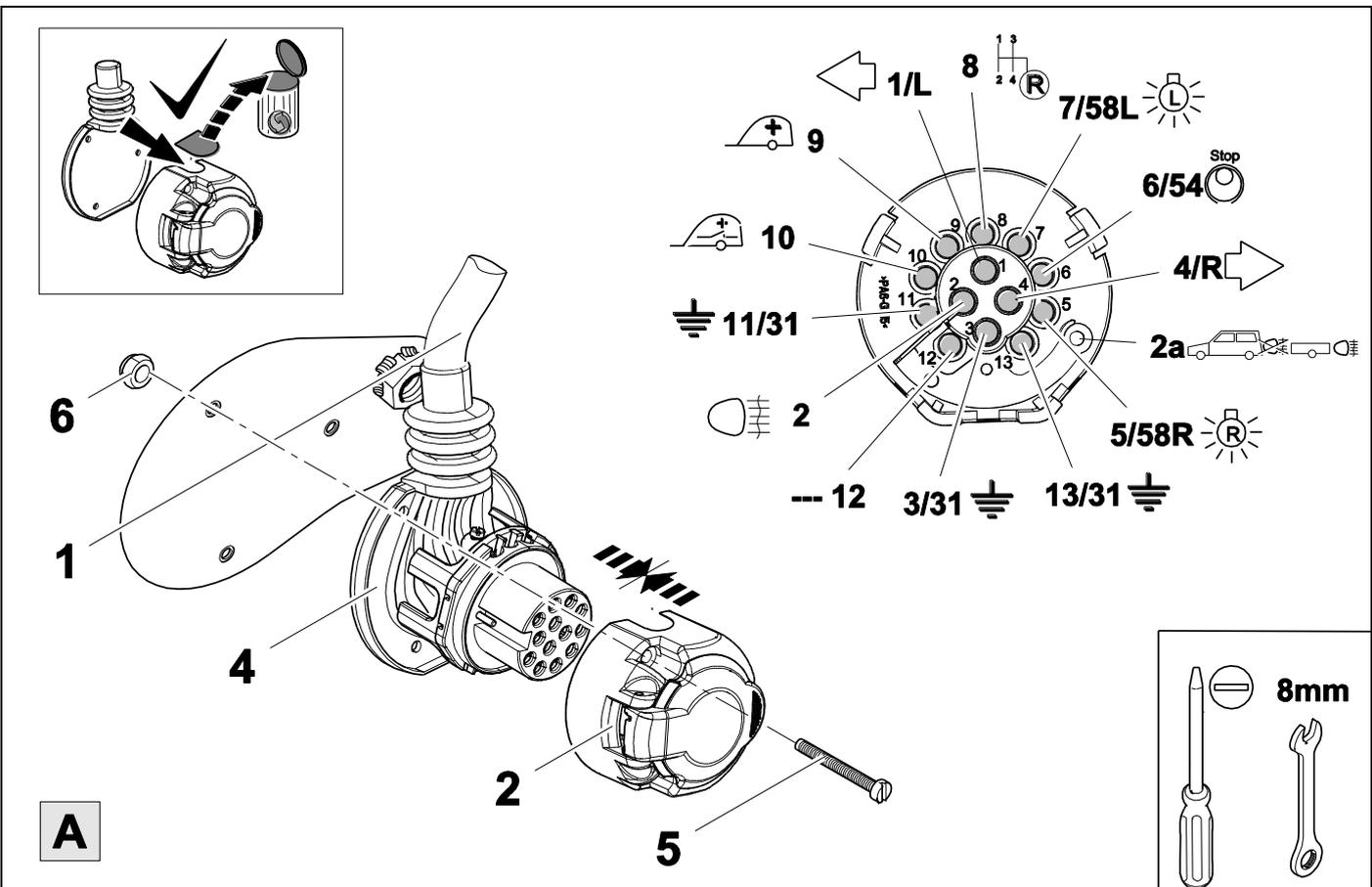

A



1	bk/wh		8	bu/rd	
2	gy, bu		9	rd/bu	
3	wh/bn		10	ye	
4	bk/gn		11	bn/gn	
5	gy/rd		12	no	
6	bk/rd		13	bn	
7	gy/bk		58b/2a	gy/bu, ye	

12	bk	wh	gy	gn	rd	bu	ye	bn	pu	or	no
<b>(D)</b>	schwarz	weiß	grau	grün	rot	blau	gelb	braun	violett	orange	nicht belegt
<b>(GB)</b>	black	white	grey	green	red	blue	yellow	brown	purple	orange	not occupied
<b>(F)</b>	noir	blanc	gris	vert	rouge	bleu	jaune	brun	violet	orange	inutilisé
<b>(NL)</b>	zwart	wit	grijs	groen	rood	blauw	geel	bruin	violet	oranje	niet aangesloten
<b>(DK)</b>	sort	hvid	grå	grøn	rød	blå	gul	brun	violet	orange	ikke anvendt
<b>(N)</b>	svart	hvit	grå	grønn	rød	blå	gul	brun	fiolett	oransje	ikke i bruk
<b>(S)</b>	svart	vit	grå	grön	röd	blå	gul	brun	violett	orange	ej använd
<b>(FIN)</b>	musta	valkoinen	harmaa	vihreä	punainen	sininen	keltainen	ruskea	violetti	oranssi	ei varattu
<b>(I)</b>	nero	bianco	grigio	verde	rosso	blu	giallo	marrone	viola	arancione	libero
<b>(E)</b>	negro	blanco	gris	verde	rojo	azul	amarillo	marrón	violeta	anaranjado	no ocupado
<b>(P)</b>	preto	branco	cinzento	verde	vermelho	azul	amarelo	castanho	violeta	laranja	não ocupado
<b>(GR)</b>	μαύρος	λευκός	Γκρι	πράσινος	κόκκινος	μπλε	κίτρινος	καφέ	Μωβ	πορτοκαλί	δεν είναι κατ'επιτημένος
<b>(PL)</b>	czarny	biały	szary	zielony	czerwony	niebiesko	żółty	brazowy	fioletowy	pomarańczowy	wolny
<b>(CZ)</b>	černý	bílý	šedý	zelený	červený	modrý	žlutý	hnědý	fialový	oranžový	neobsazen
<b>(TR)</b>	siyah	beyaz	gri	yeşil	kırmızı	mavi	sarı	kahverengi	mor	portakal rengi	boş
<b>(H)</b>	fekete	fehér	szürke	zöld	piros	kék	sárga	barna	ibolyakék	narancssárga	nem foglalt
<b>(HR)</b>	crno	bijelo	sivo	zeleno	crveno	plavo	zuto	smeđe	ljubičasto	narandasto	nije zauzeto
<b>(BUL)</b>	черен	бял	сив	зелен	червен	син	жълт	кафяв	виолетов	оранжев	свободно
<b>(RO)</b>	negru	alb	gri	verde	roșu	albastru	galben	maro	violet	portocaliu	liber
<b>(RU)</b>	черный	белый	серый	зеленый	красный	голубой	желтый	коричневый	пурпурный	оранжевый	свободно
<b>(LT)</b>	juoda	balta	pilka	žalia	raudona	mėlyna	geltona	ruda	purpurinė	oranžinė	laisva
<b>(LV)</b>	melna	balta	pelēka	zaļa	sarkana	zila	dzeltena	brūna	purpur-sarkana	oranža	brīvs
<b>(EST)</b>	must	valge	hall	roheline	punane	sinine	kollane	pruun	purpur-punane	oraanž	vaba
<b>(SLO)</b>	črna	bela	siva	zelena	rdeča	modra	rumena	smeđ	vijoličast	oranžen	ni zasedeno
<b>(SK)</b>	čierny	biely	šedý	zelený	červený	modrý	žltý	hnědý	fialový	pomarančový	neobsadený

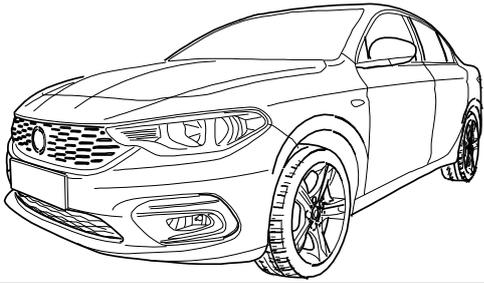

TIPO  
SEDAN

14



19

32



59

TIPO  
HATCHBACK

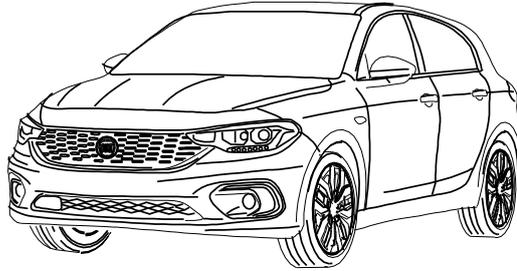

20



25

32



59

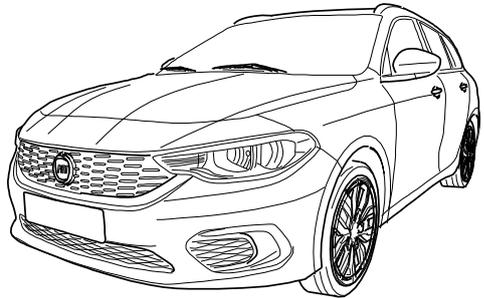

TIPO  
COMBI

26



59

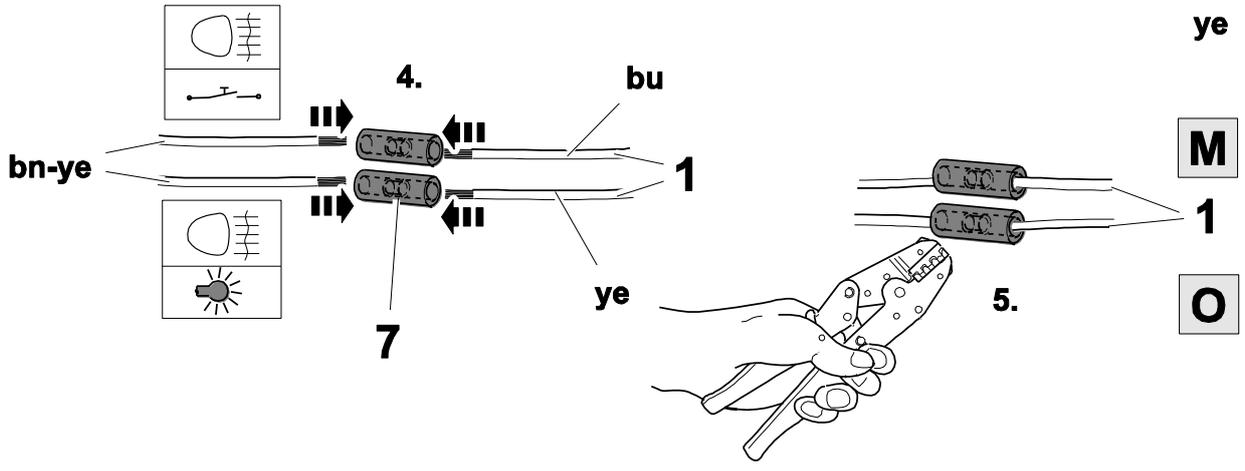
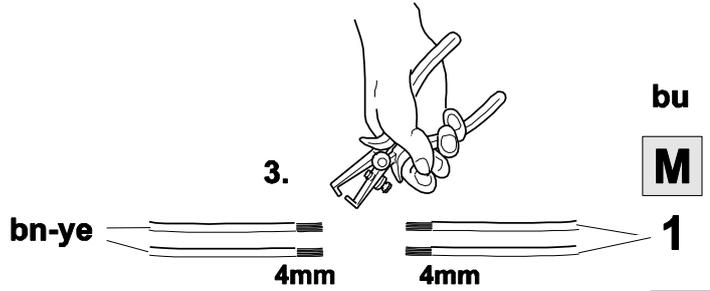
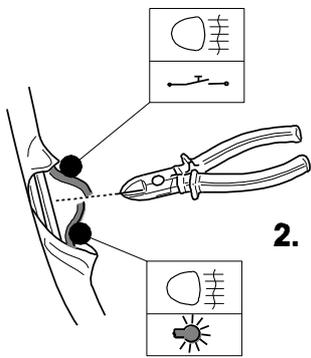
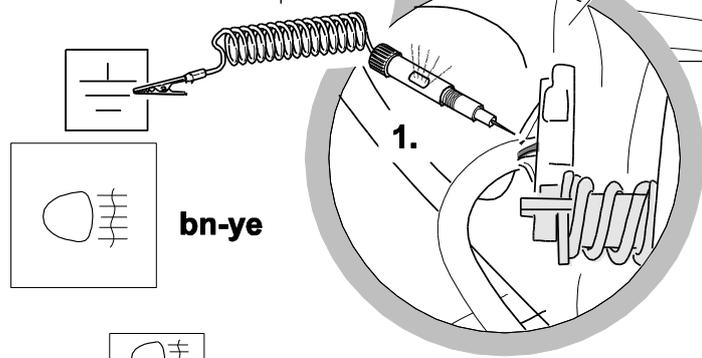
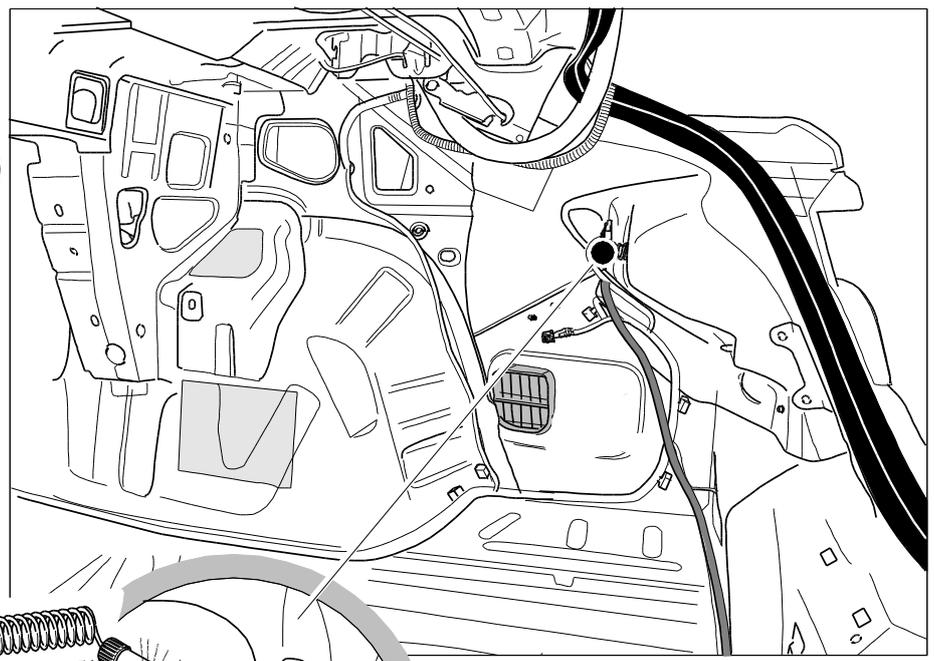
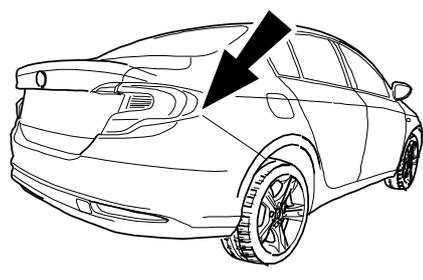

15

Sedan

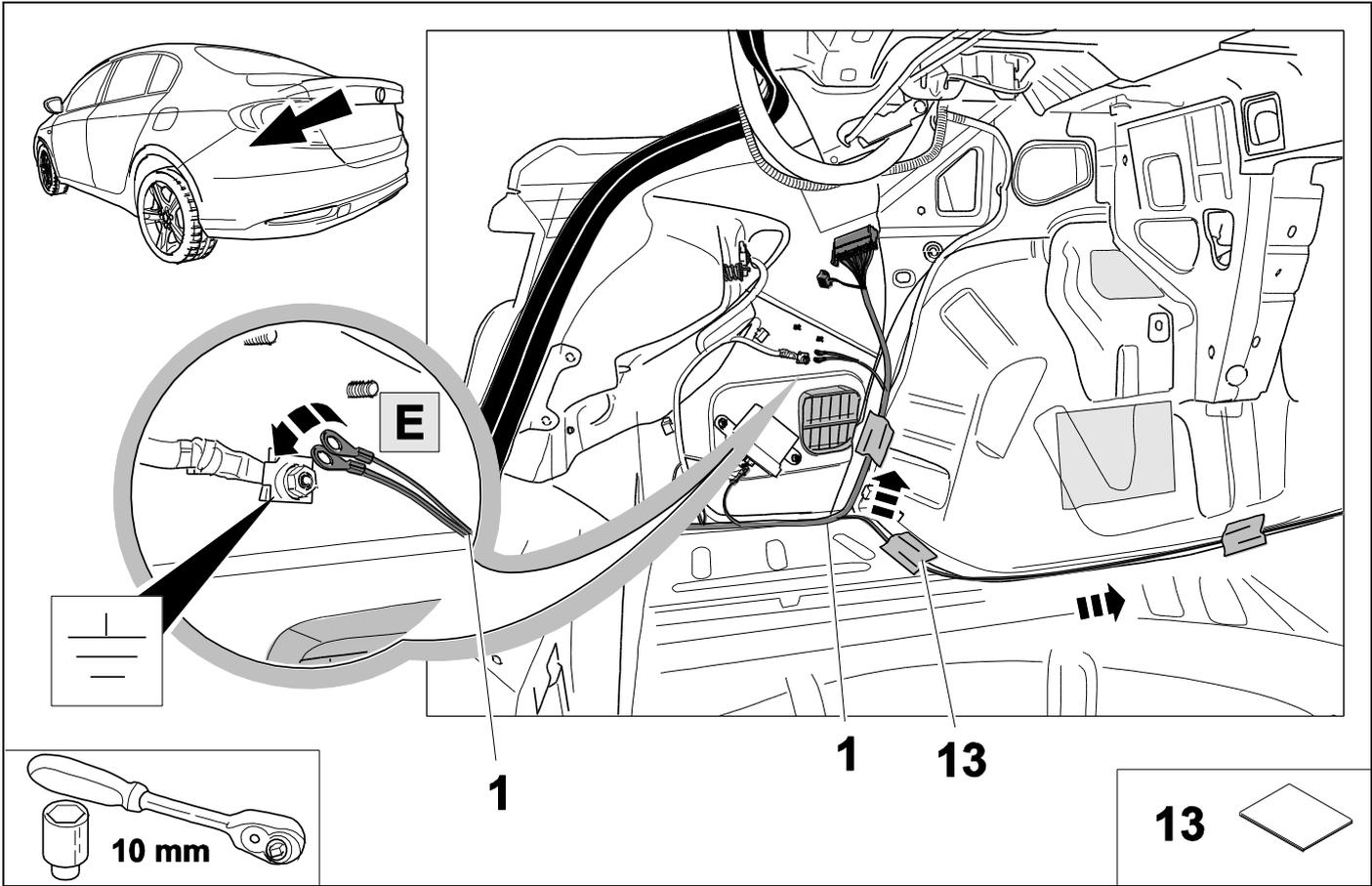

16

Sedan

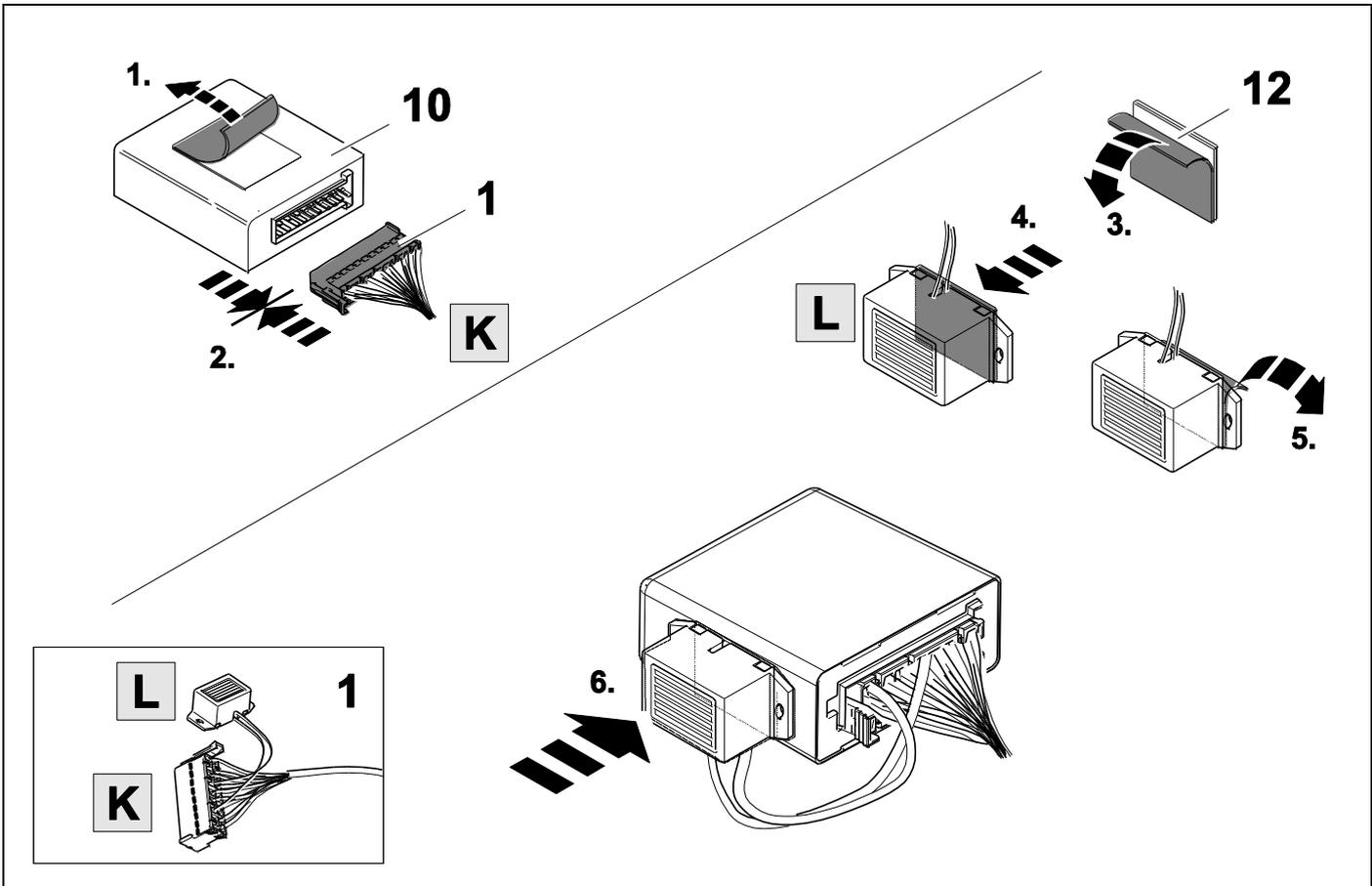





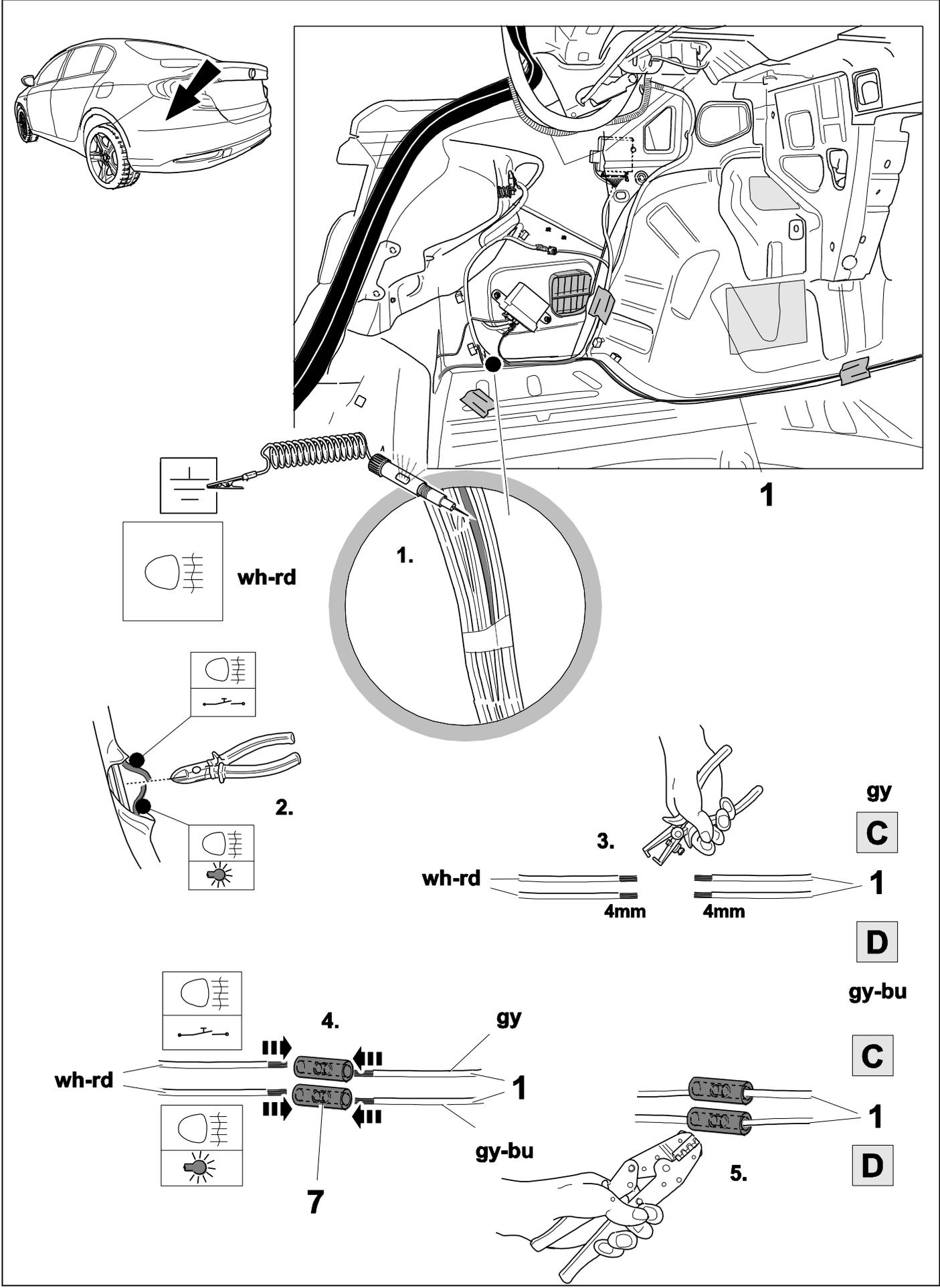

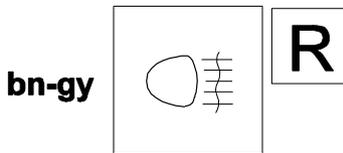
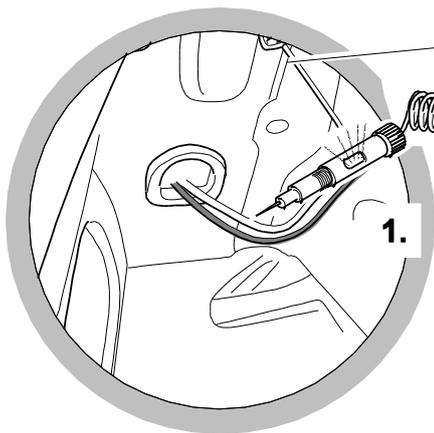
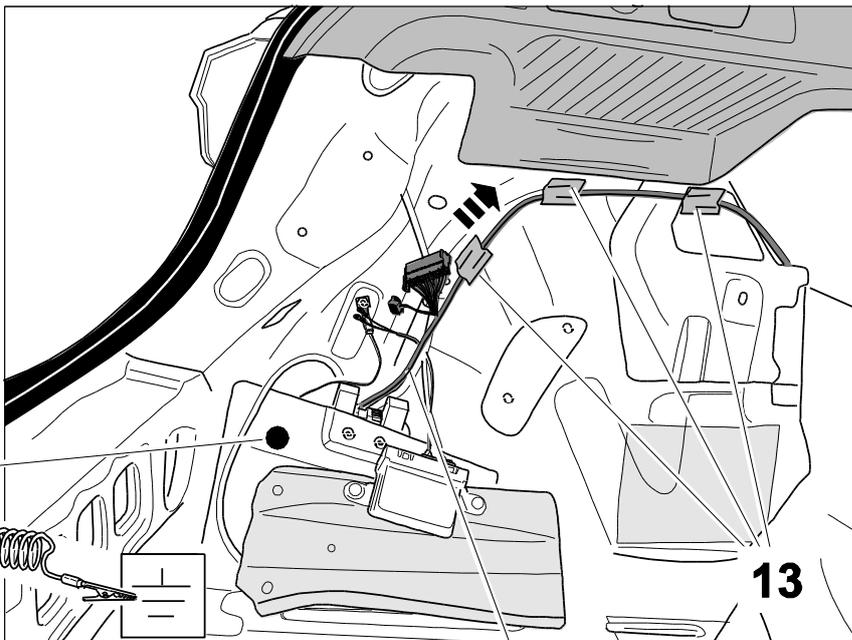
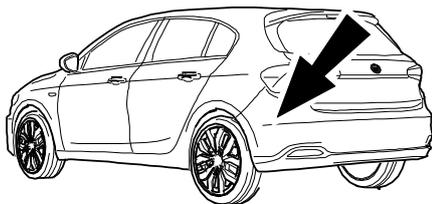

1

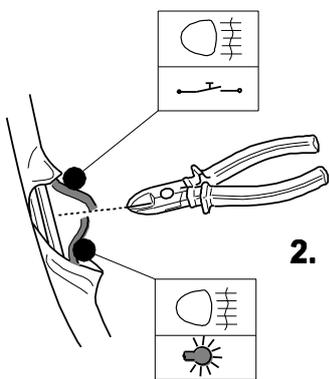

2.

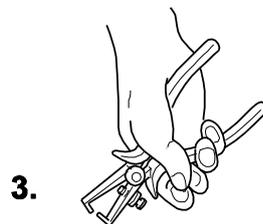

3.

bu

L

1

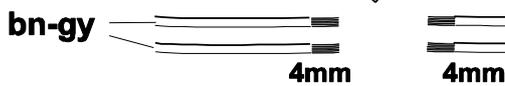

4mm

4mm

M

ye

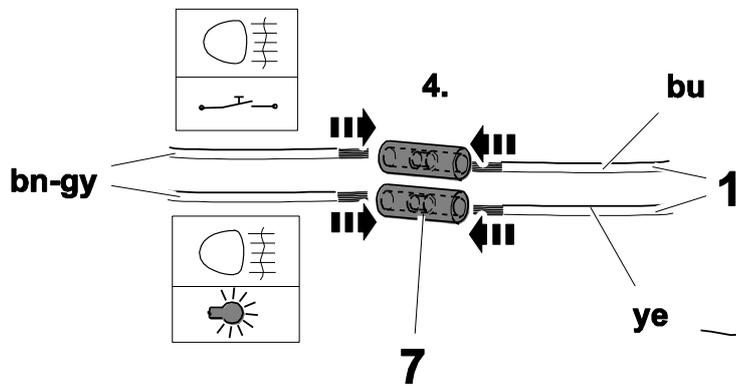

4.

bu

bn-gy

1

ye

7

L

1

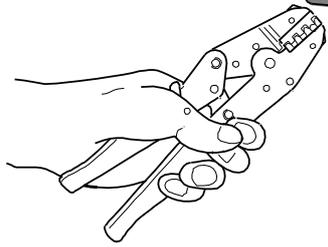

5.

M

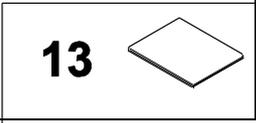

13

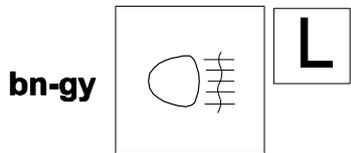
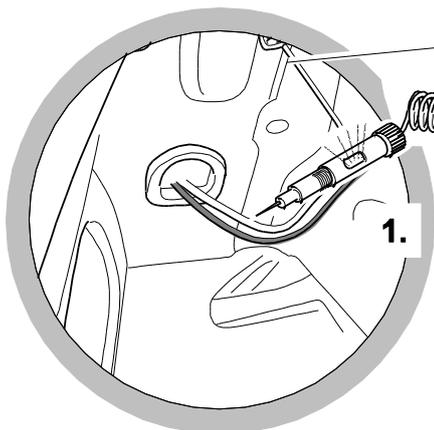
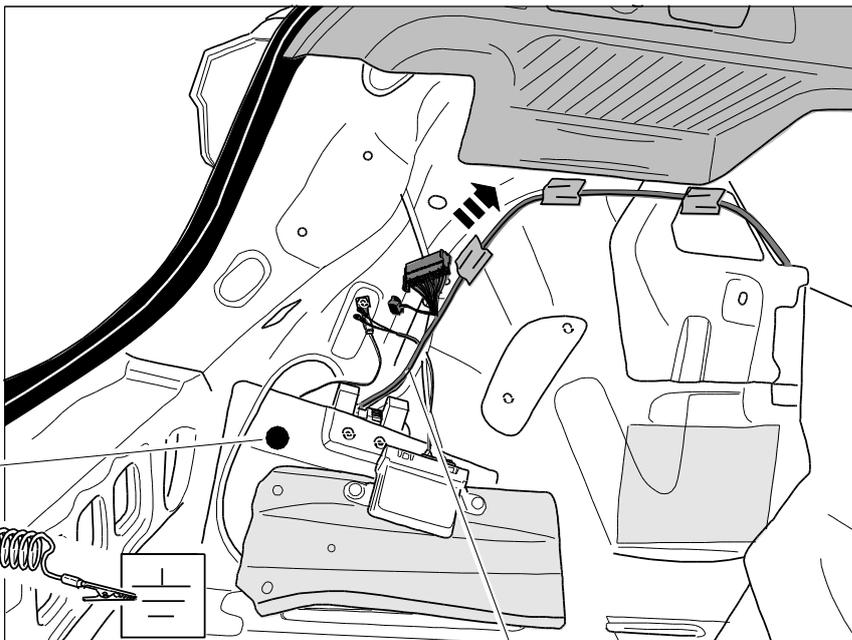
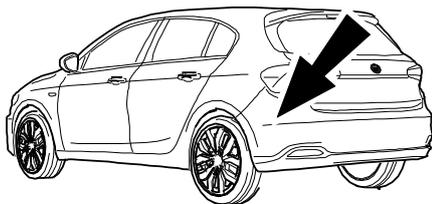

1

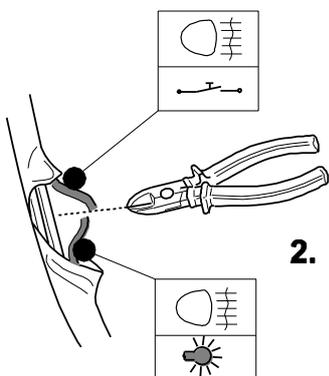

2.

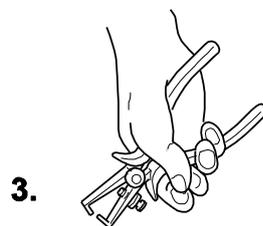

3.



gy

C

1

4mm

4mm

D

gy-bu

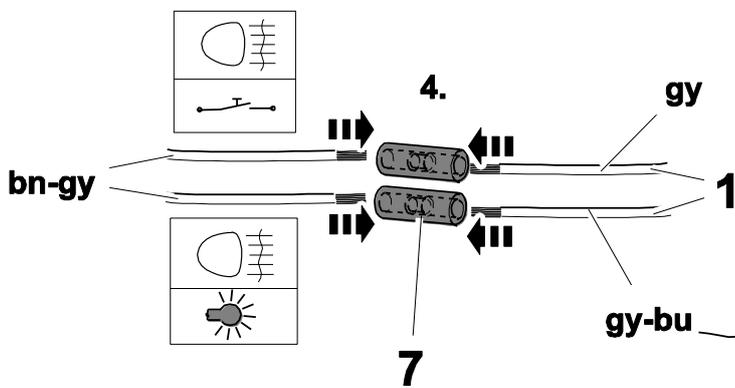

4.

gy

bn-gy

1

gy-bu

7

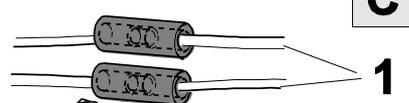

C

1

5.

D

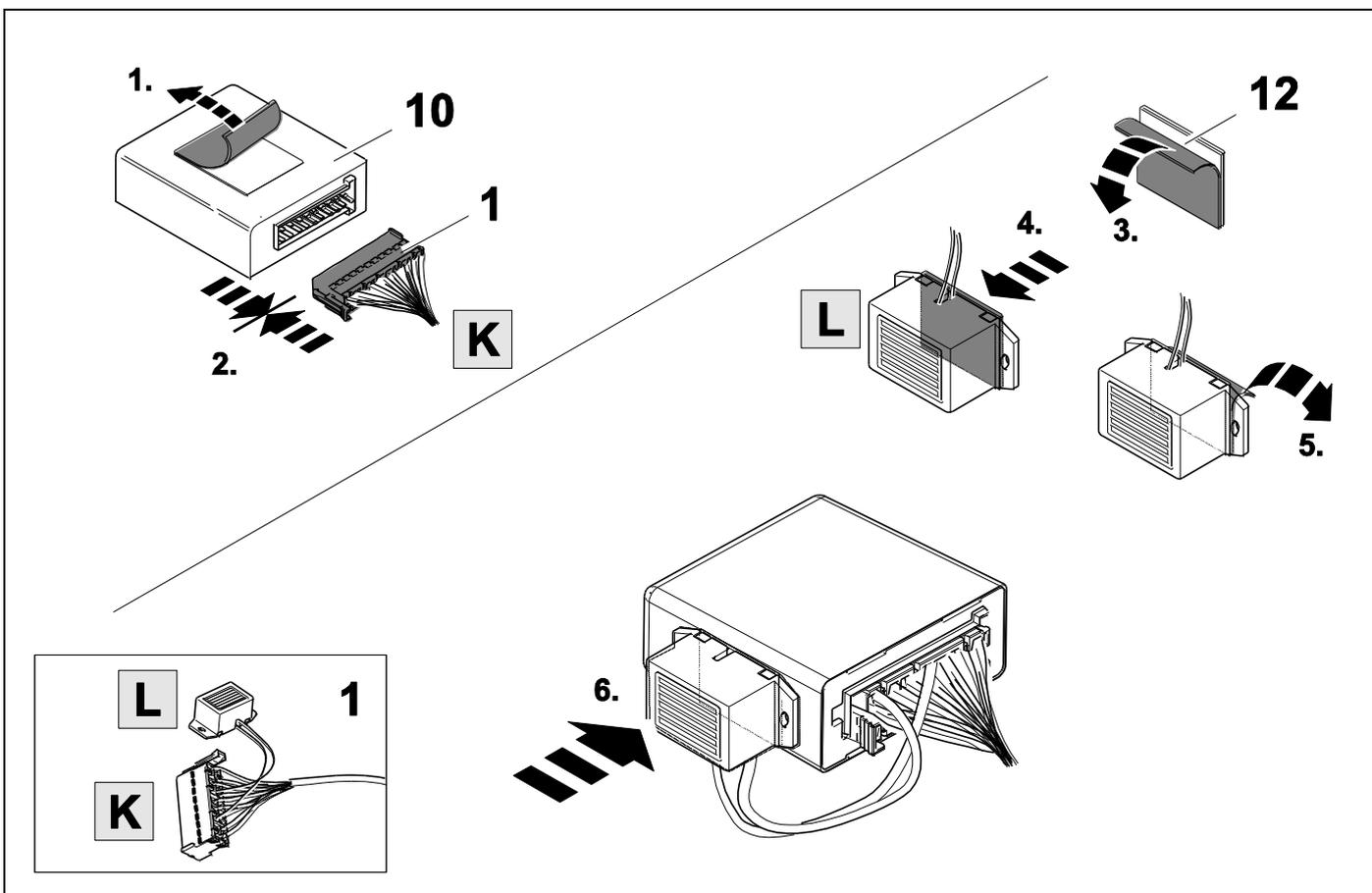
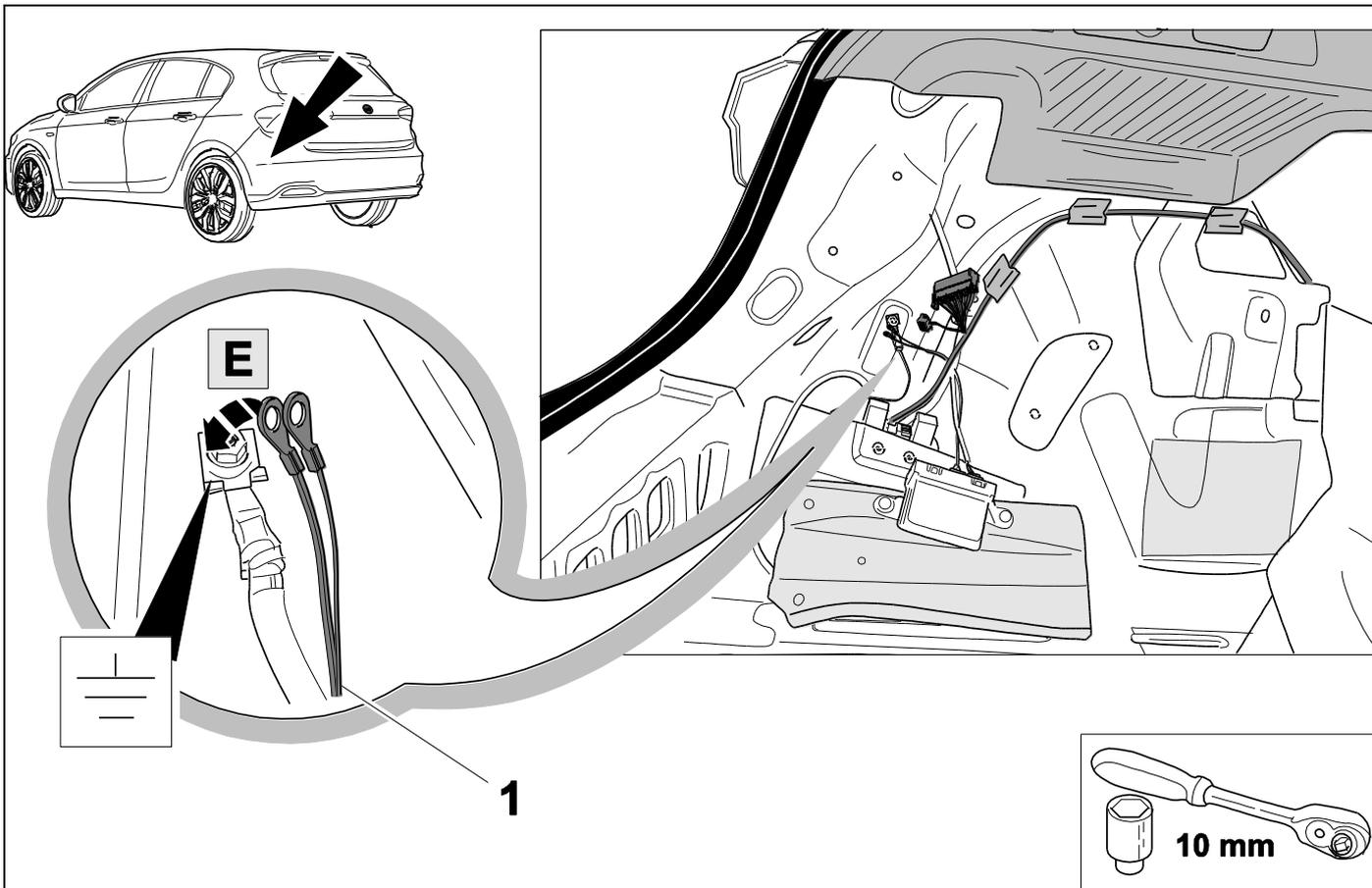

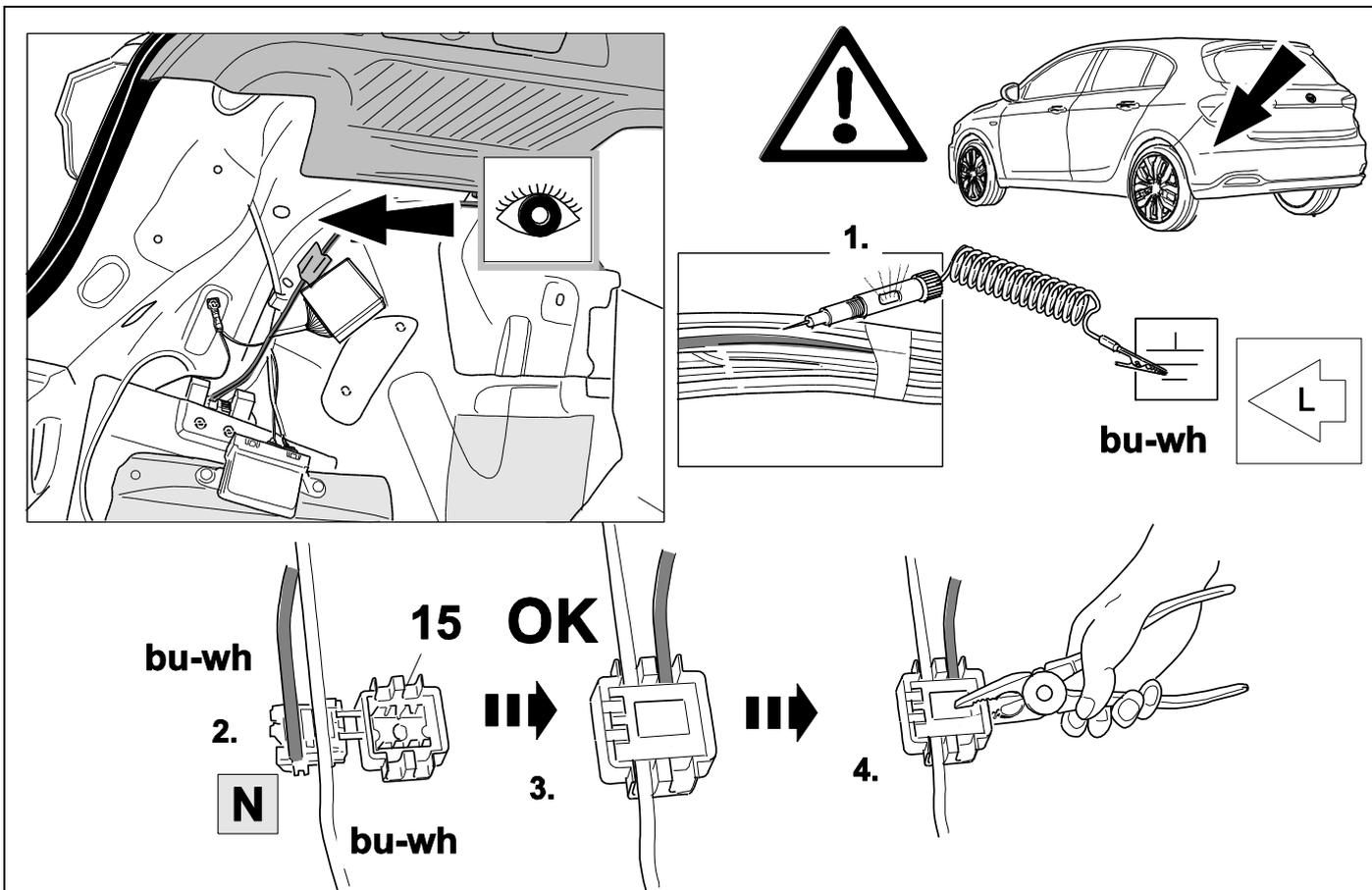
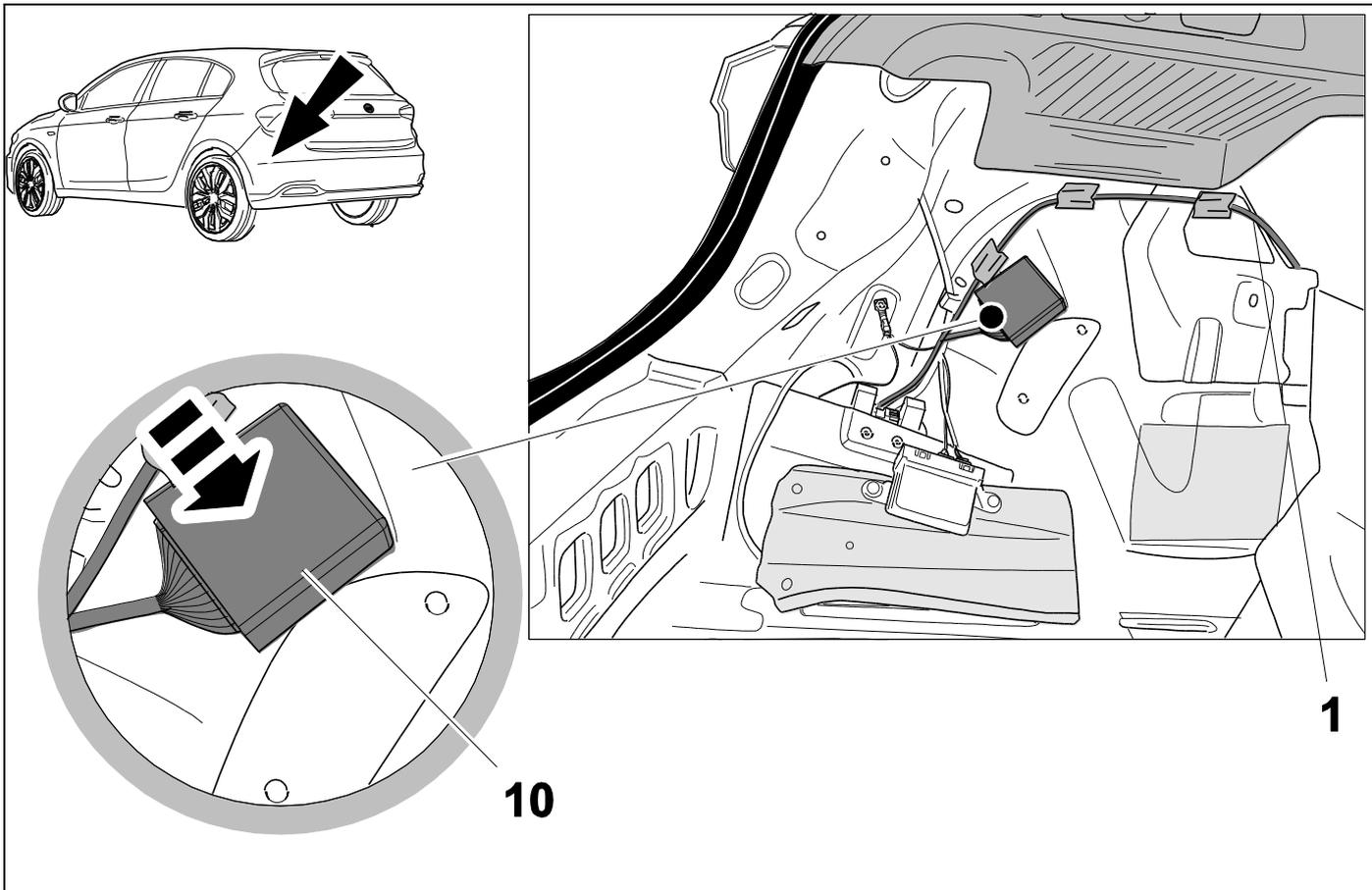

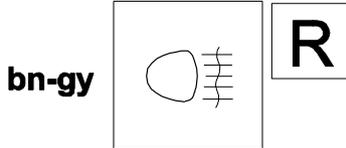
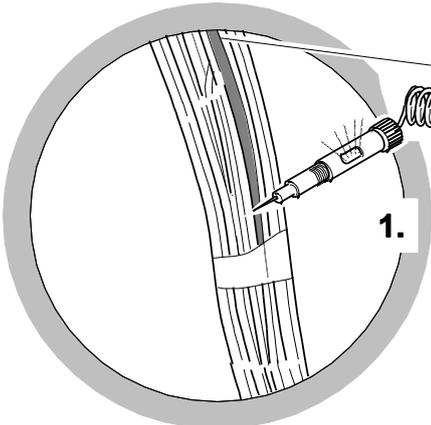
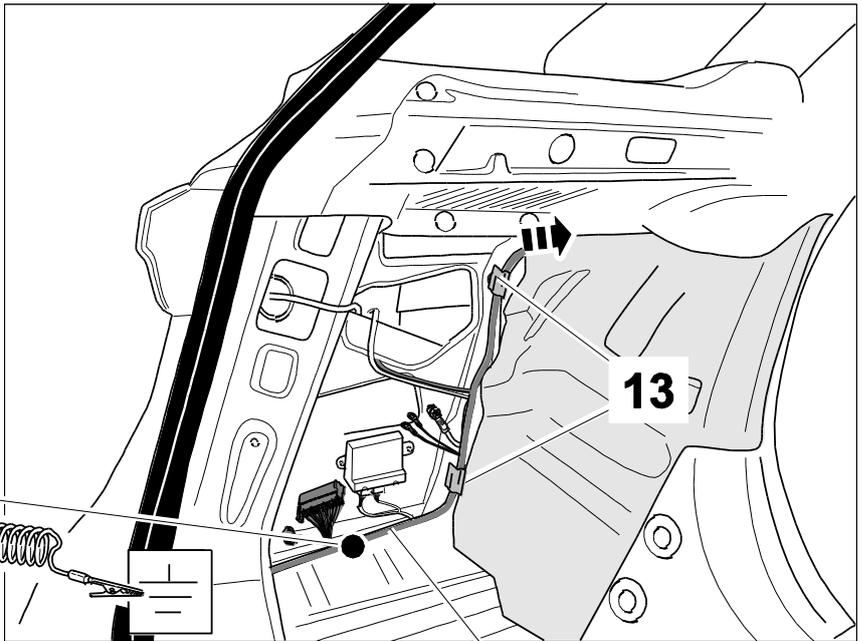
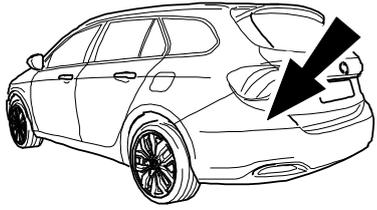

1

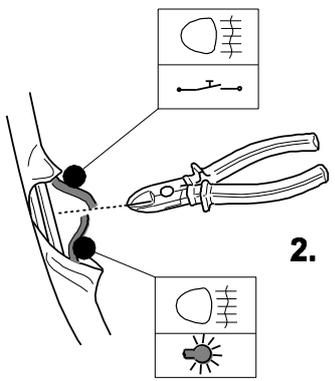

2.

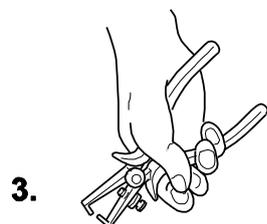

3.

bu  
M



N  
ye

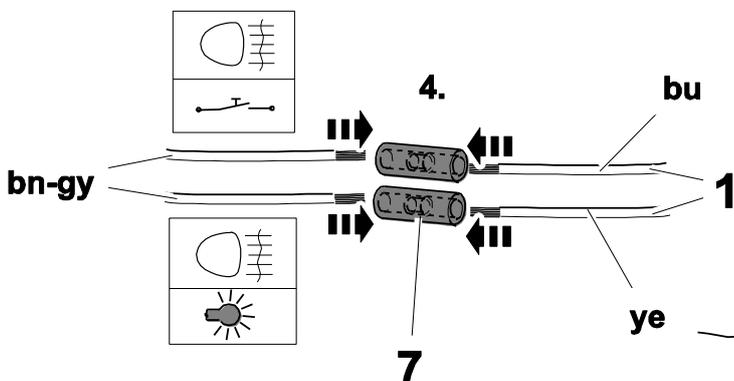

4.

bu

bn-gy

1

ye

7

M

N

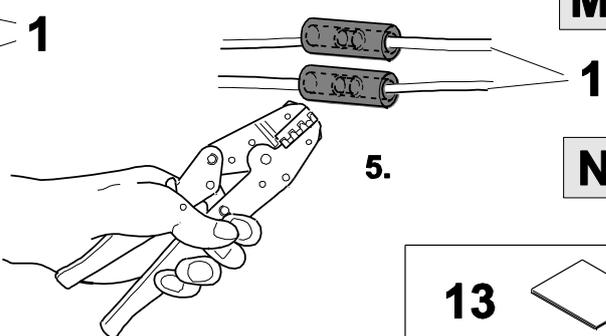

5.

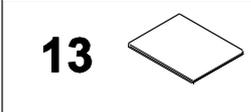

13

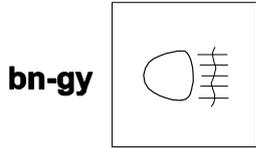
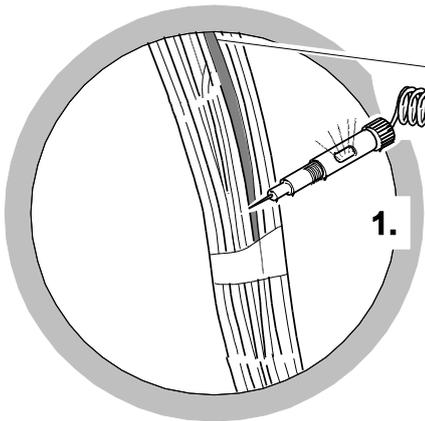
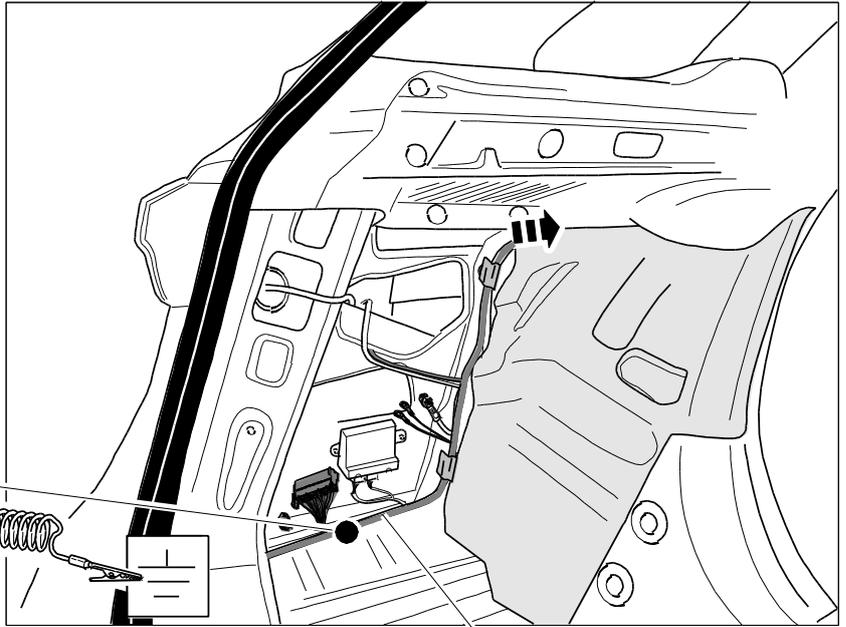
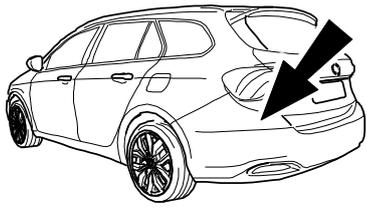

1

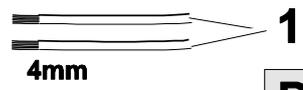
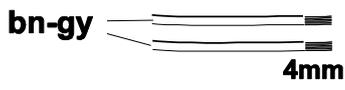
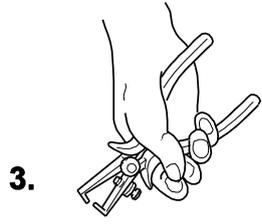
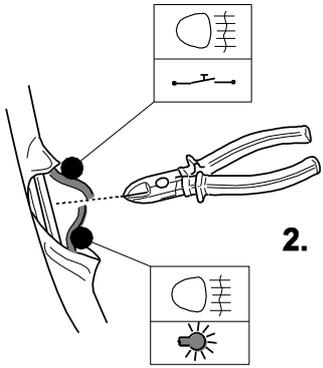

gy  
C

D

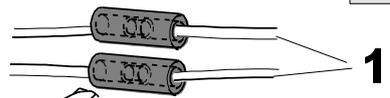
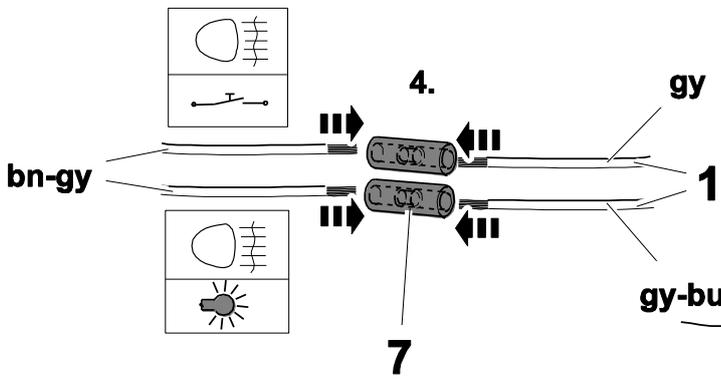

C

D

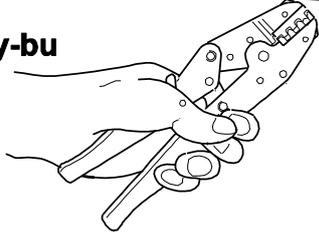



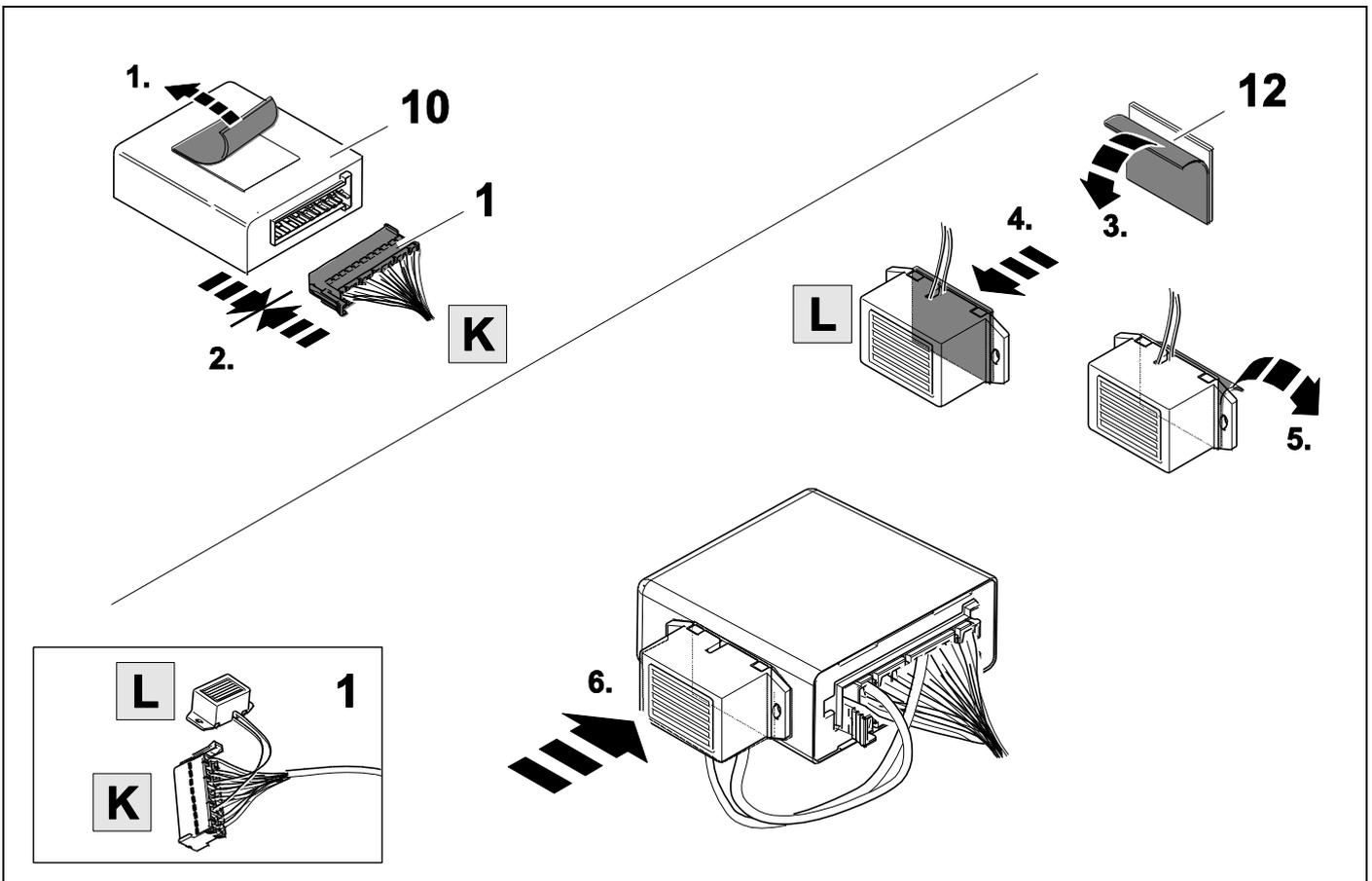
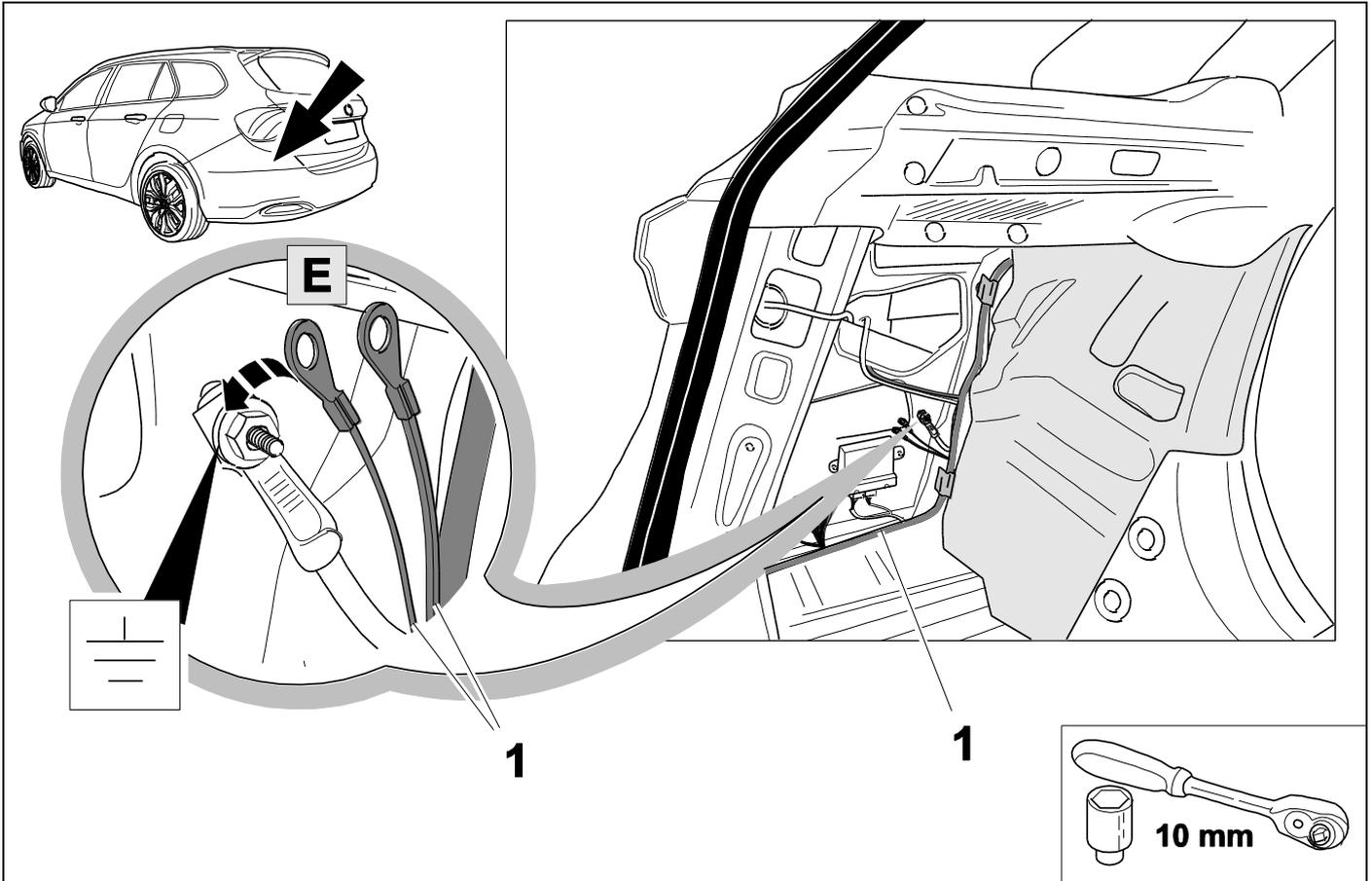

30

Combi

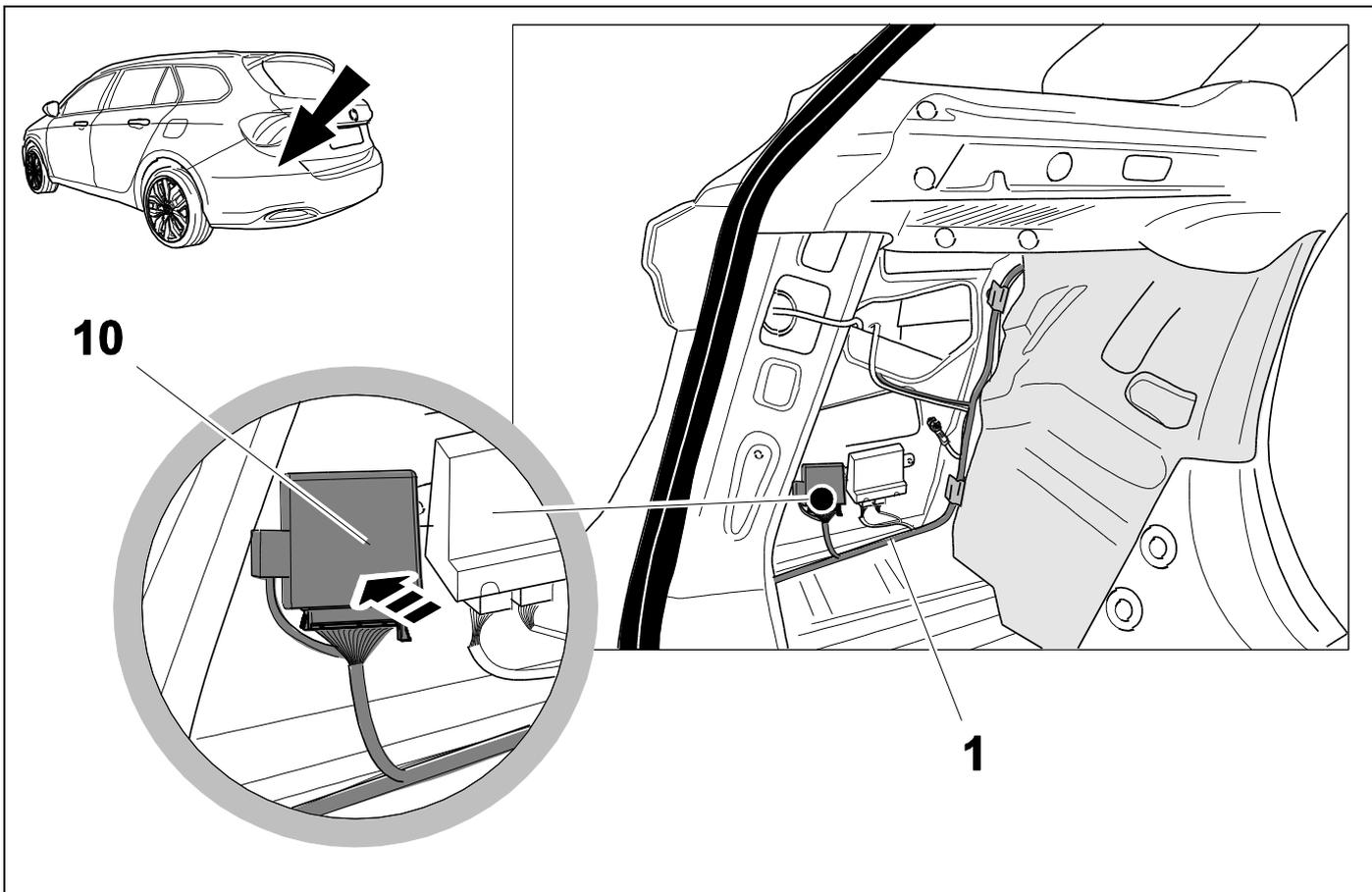

31



12

Combi

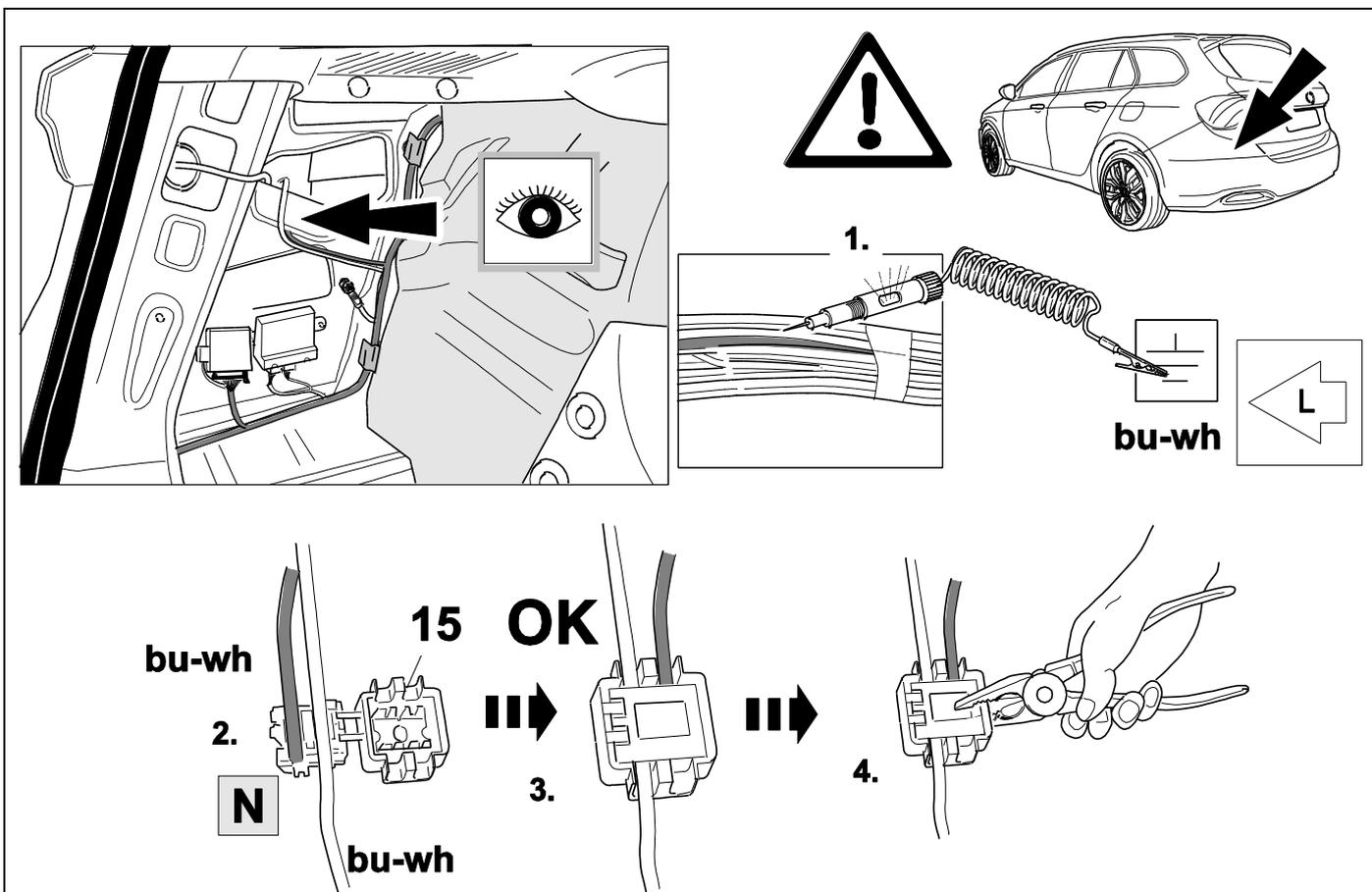

32

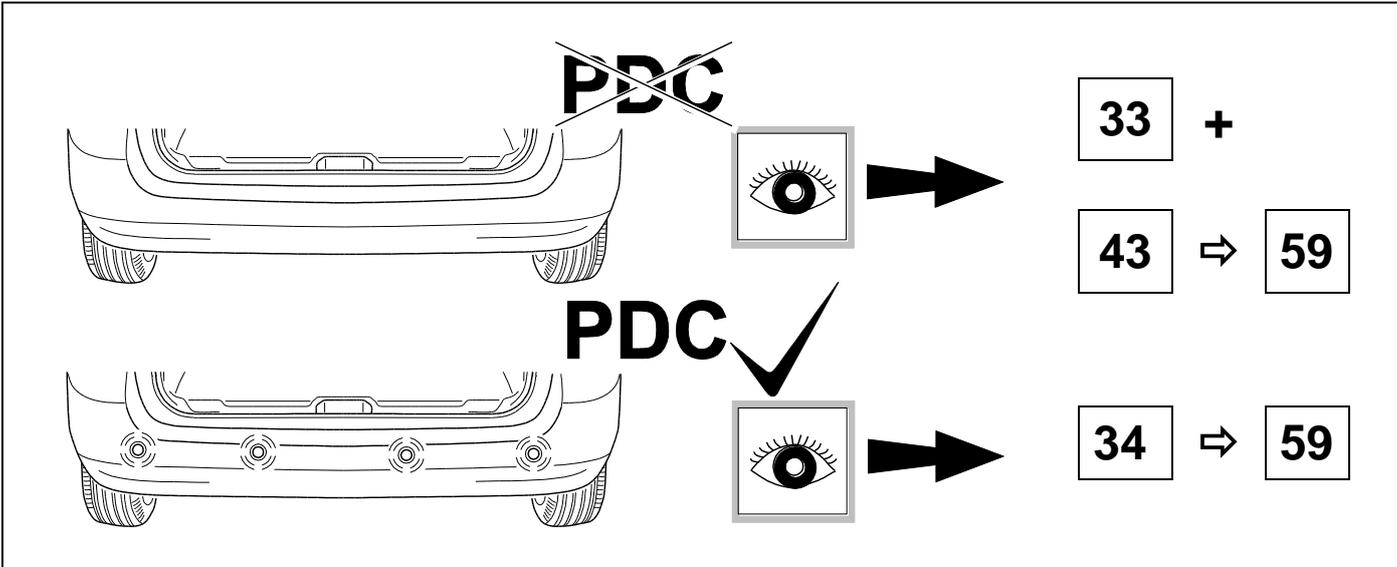

33

👁️ ⇒ 12

~~P~~

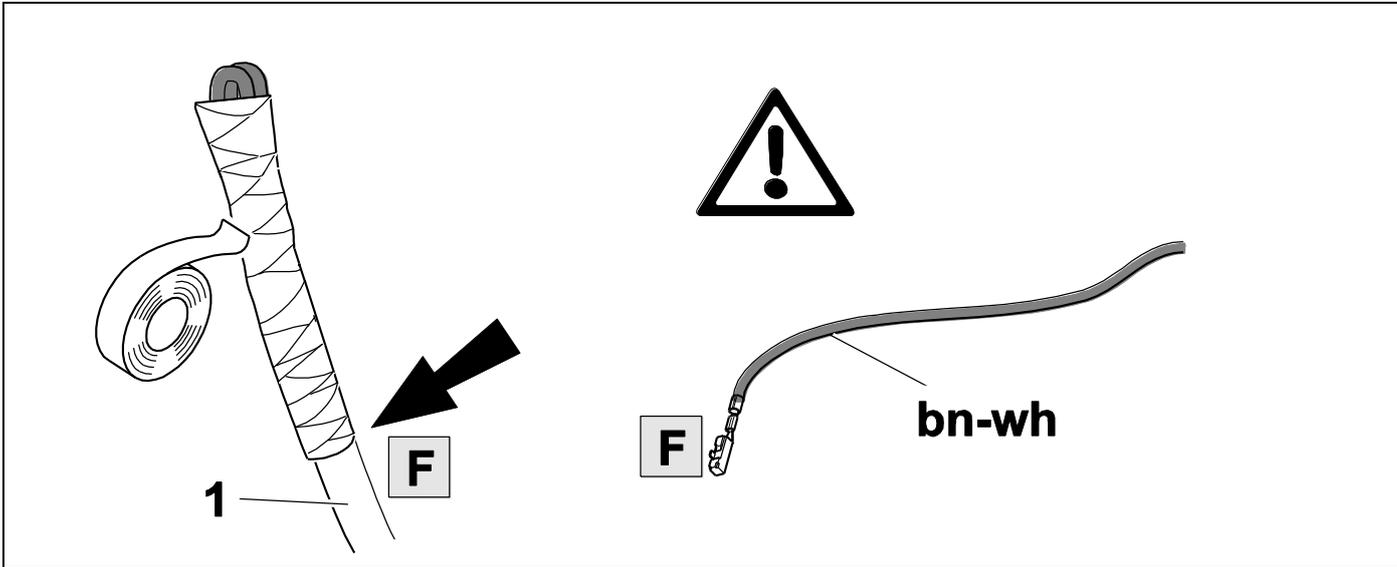

34

Sedan

👁️ ⇒ 12

P

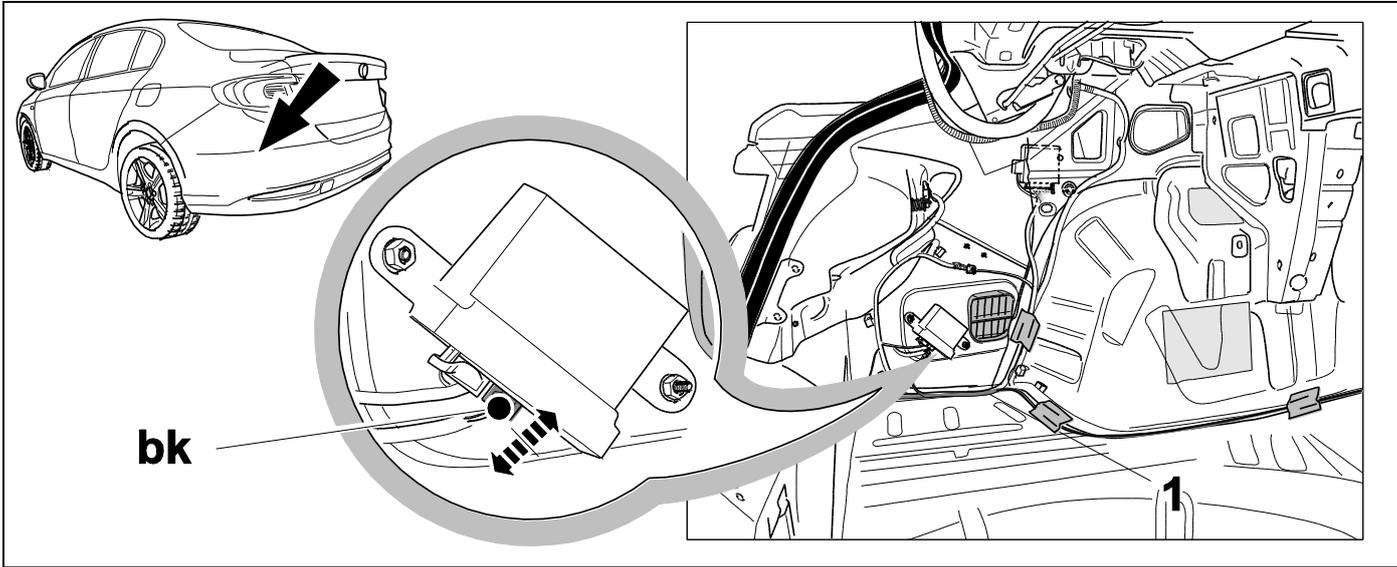

**35 Hatchback**



**12**

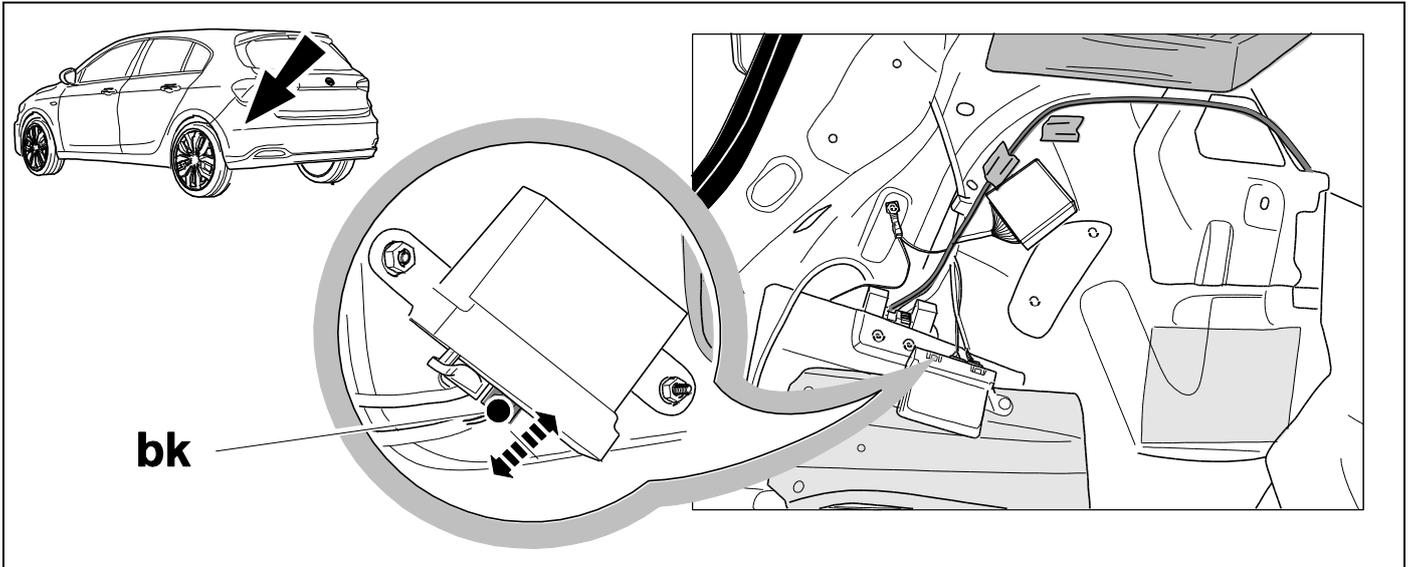

**36 Combi**



**12**

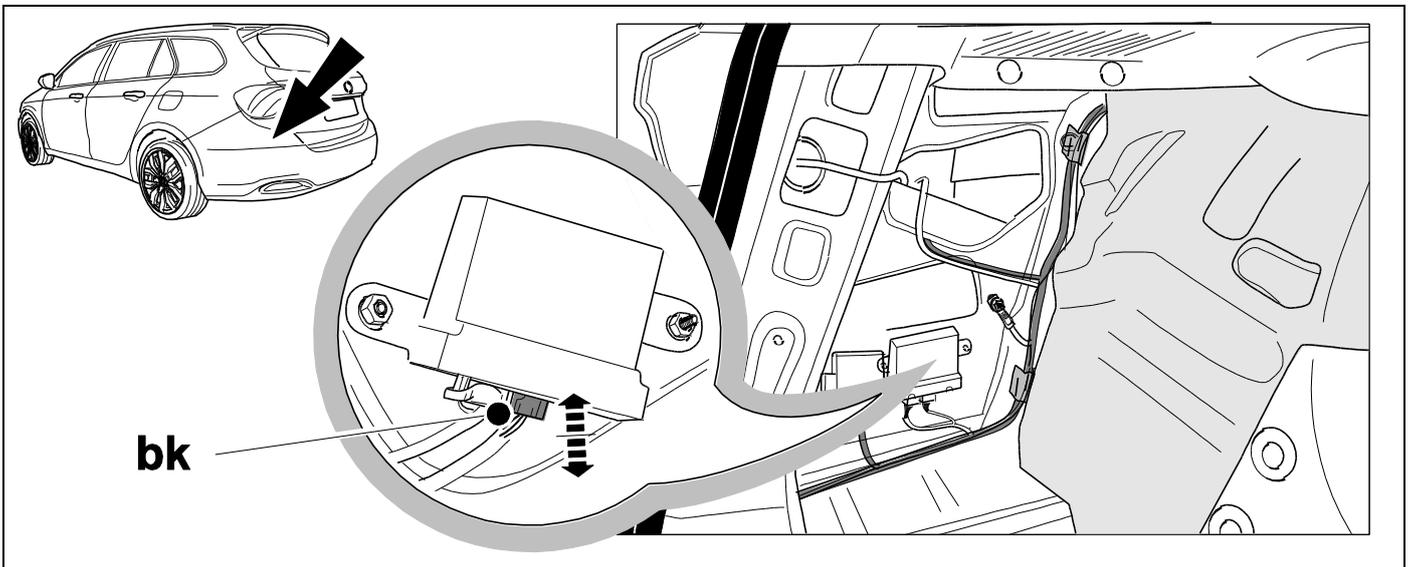

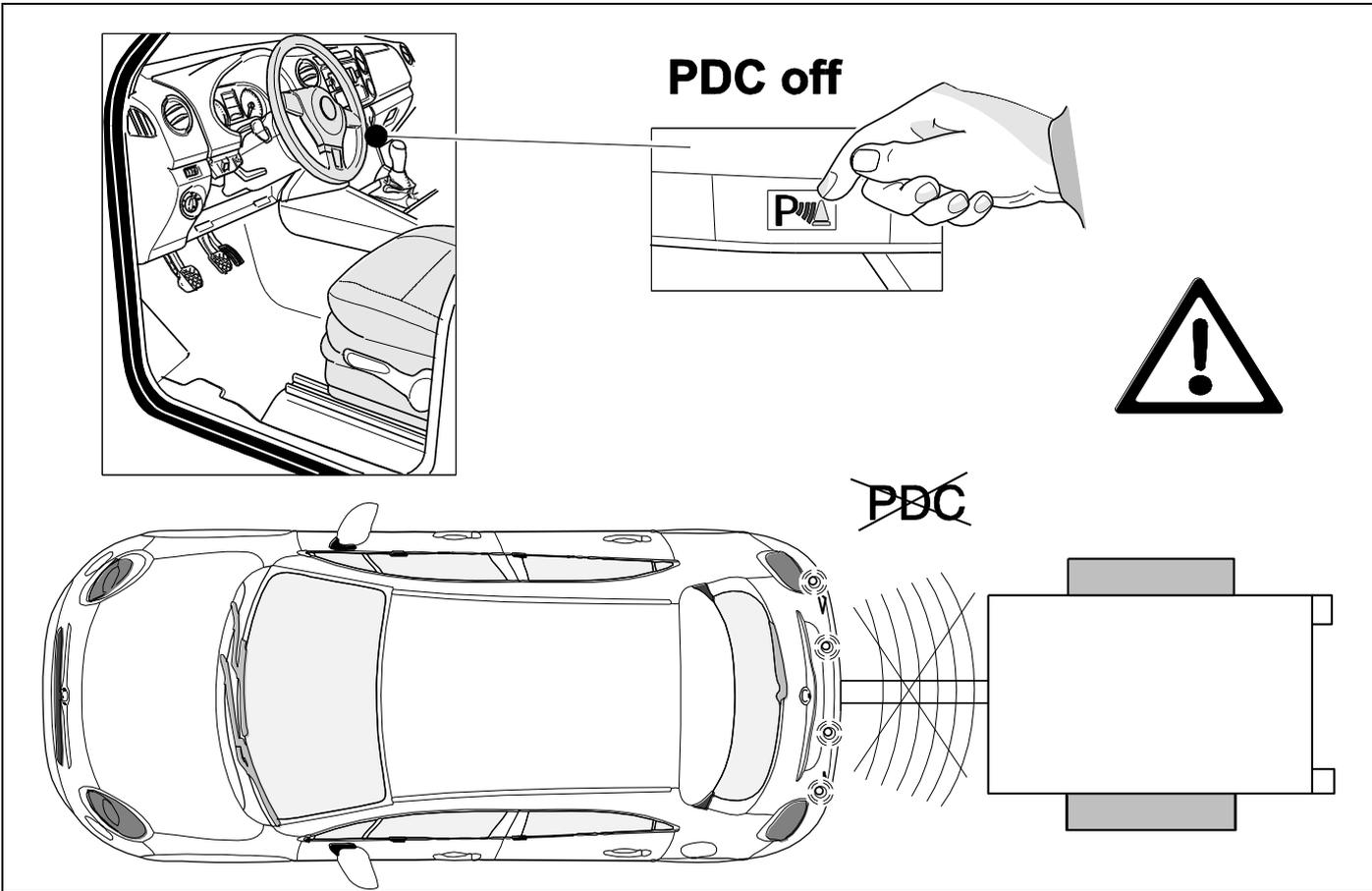
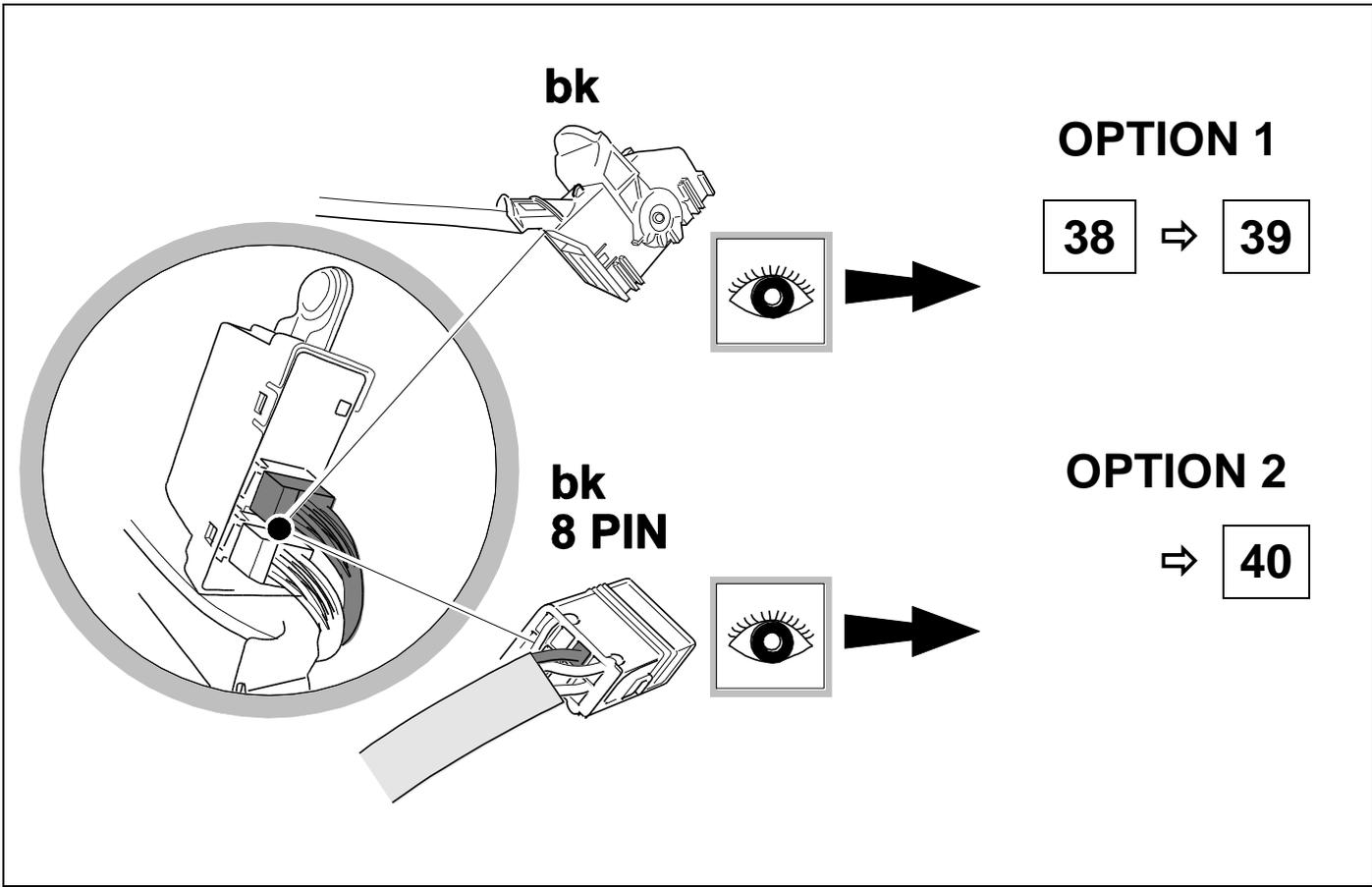

**39** **OPTION 1**

 ⇒ **12**

**P**  

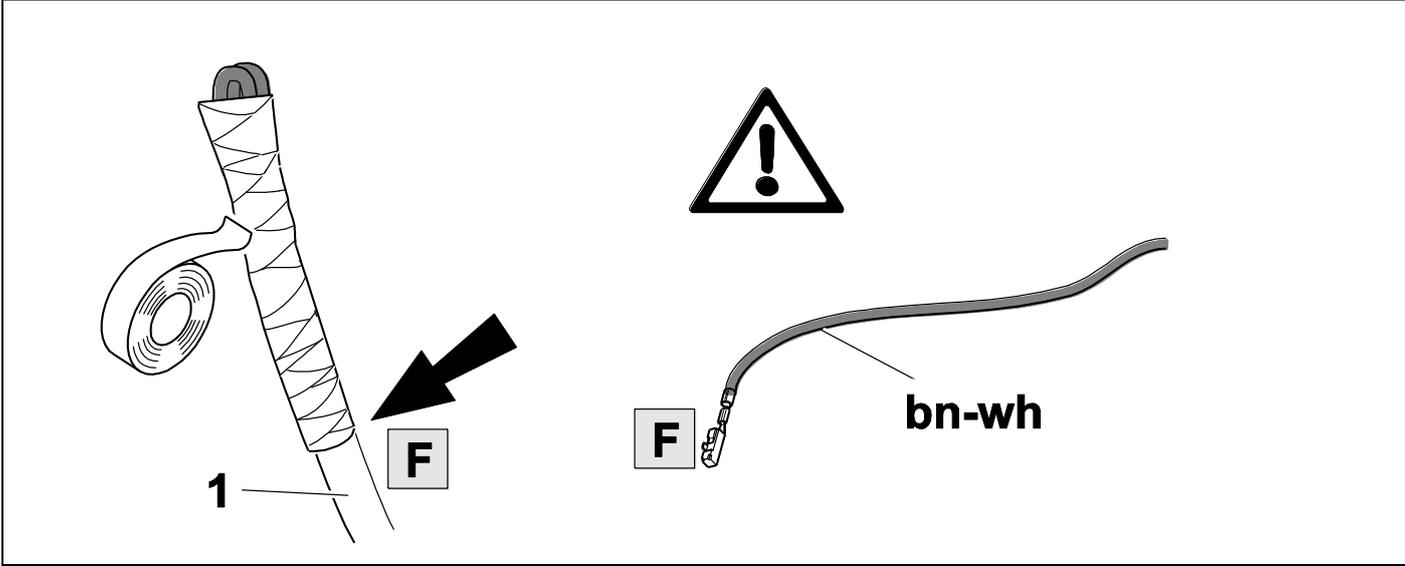

**40** **OPTION 2**

**P**  

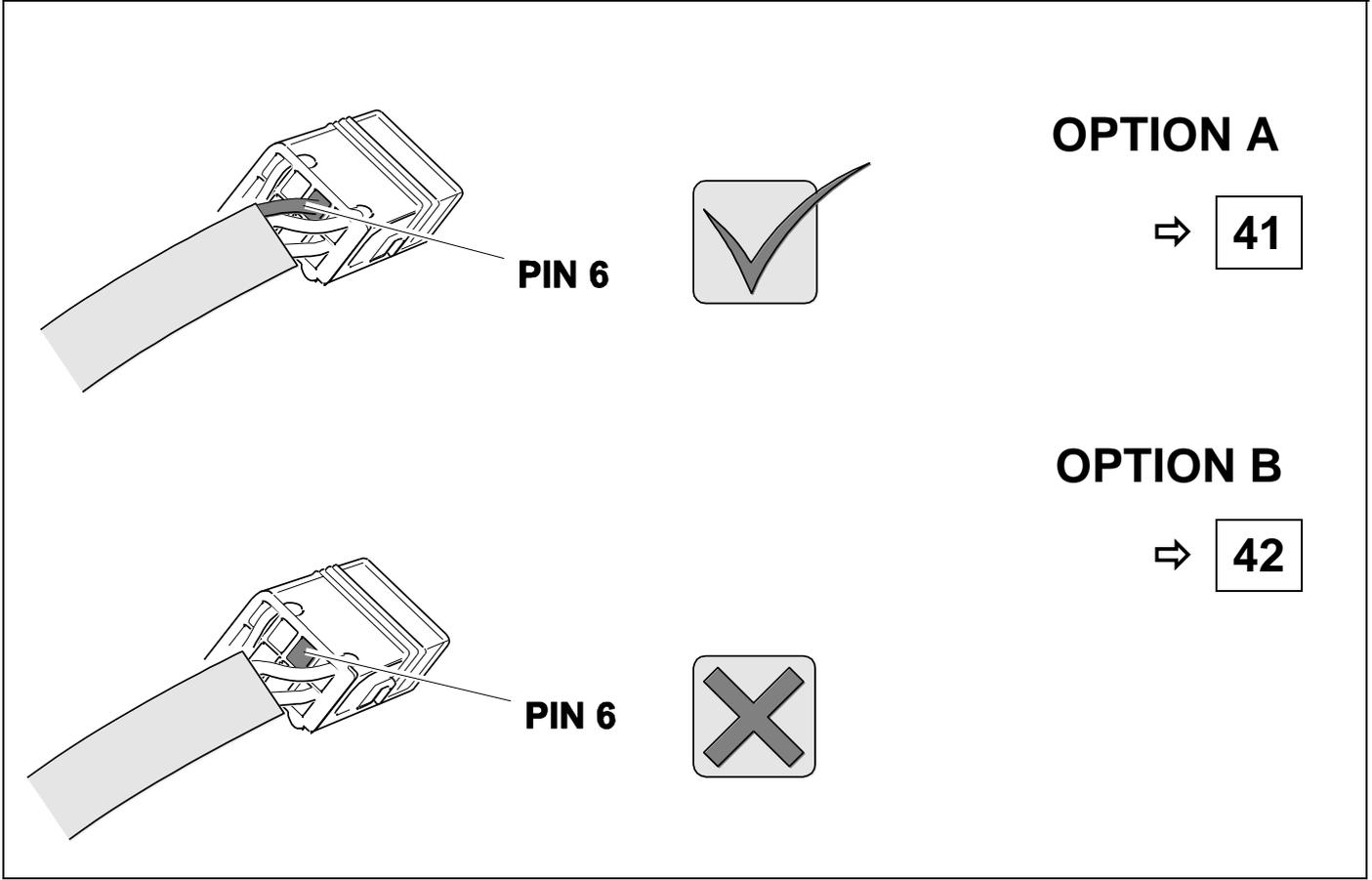

**41 OPTION A**

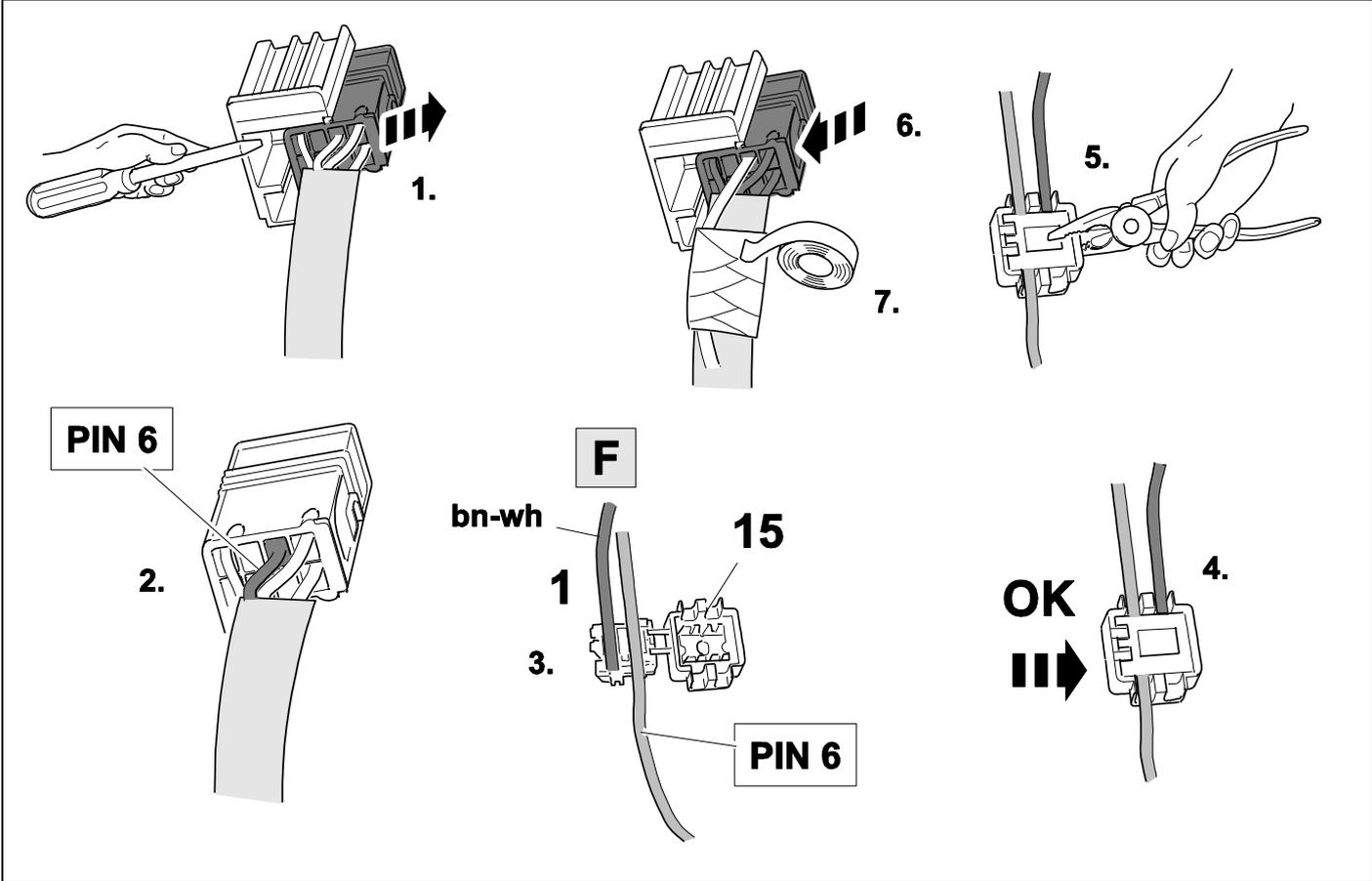
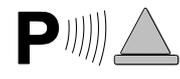

**42 OPTION B**

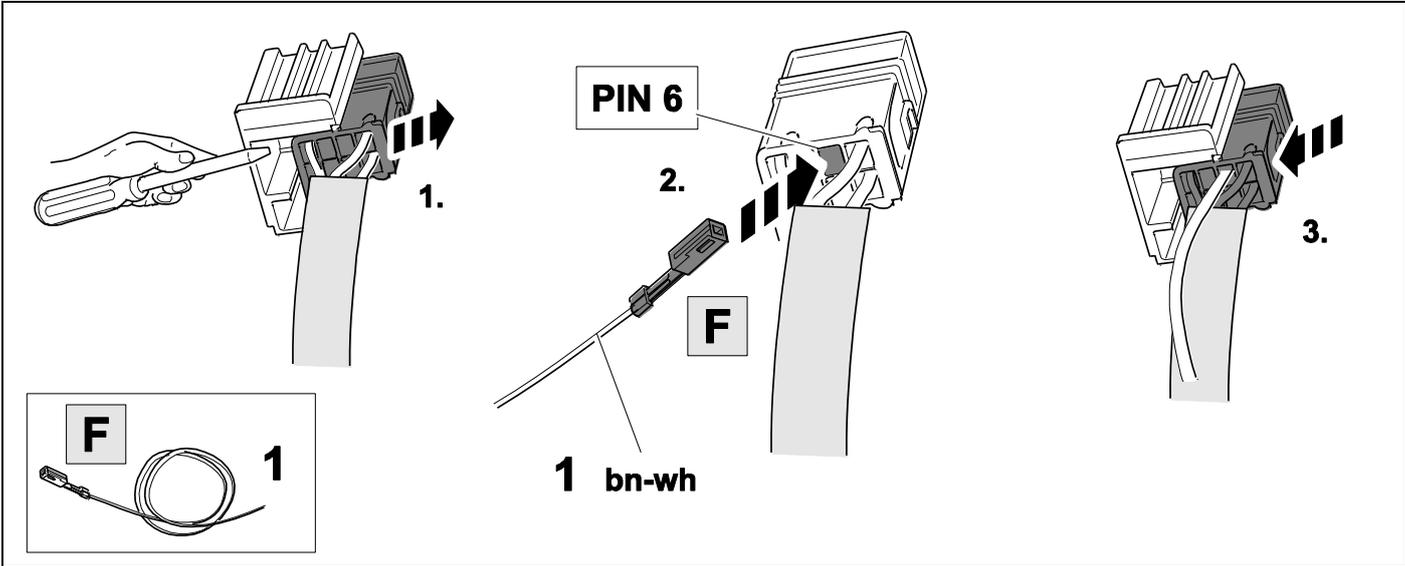

43

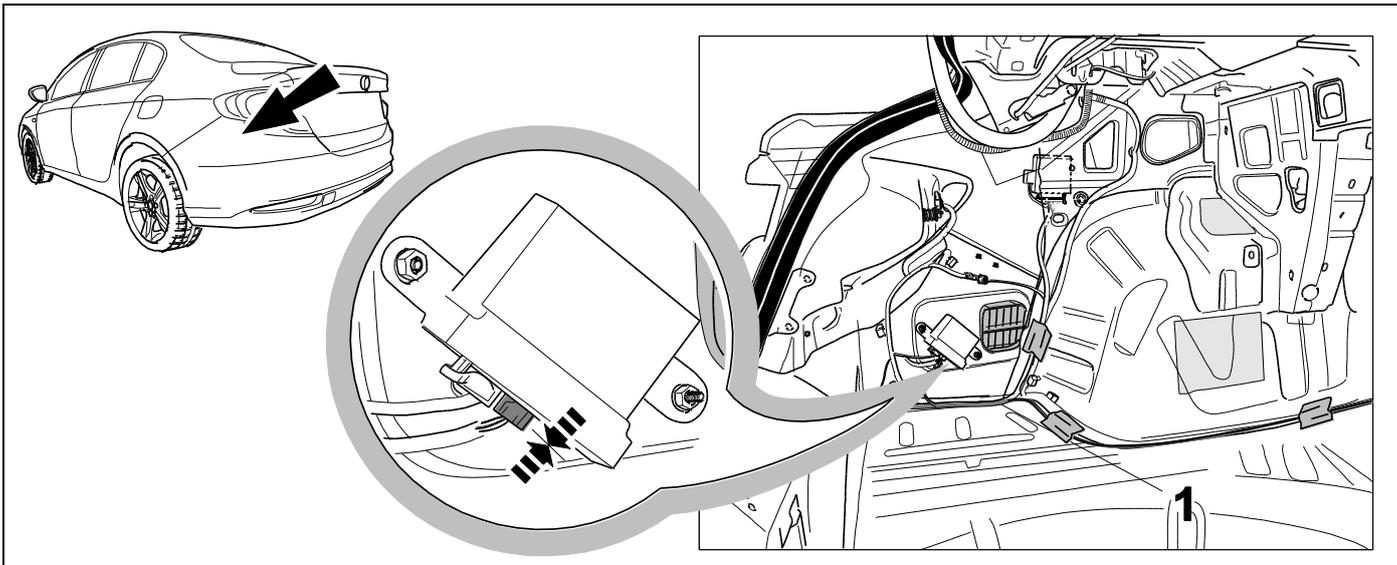

44

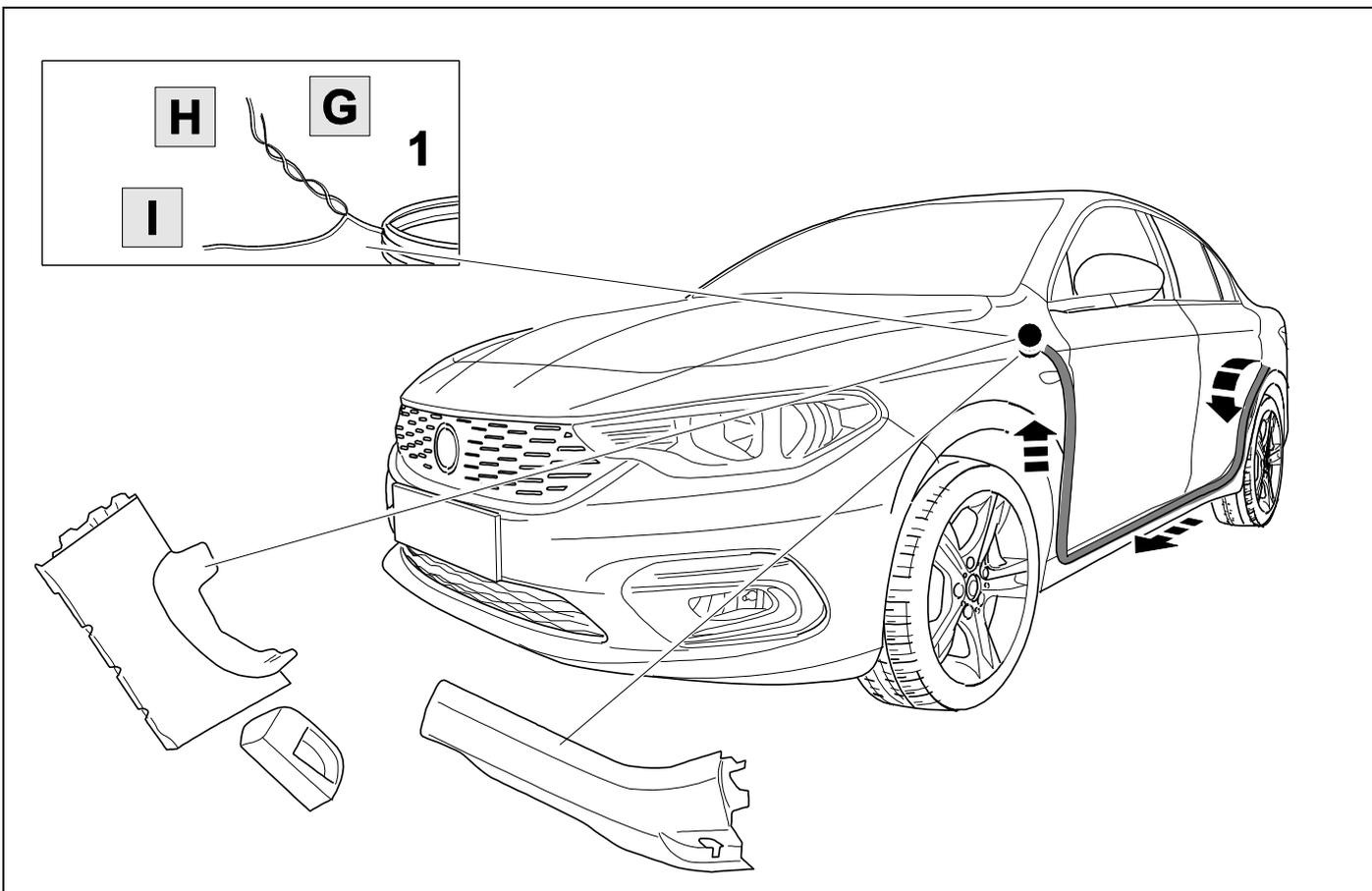



45

👁️ ⇒ 12

**OBD**

**PIN 6** gn

**PIN 14** bn

bn

**H** bn

**G** bn-rd

15

15

Diagram description: This diagram shows the location of the OBD-II connector in a car's engine compartment. An inset shows the connector's 16-pin layout. Pin 6 is green (gn) and Pin 14 is brown (bn). Below, a wiring harness is shown with two connectors labeled 15. One connector is brown (bn) and labeled H, the other is brown-red (bn-rd) and labeled G.

46

👁️ ⇒ 12

1. 4mm rd-wh I

4mm rd-bu J

2. I J

3. 14 I

4. 18 J

Diagram description: This diagram illustrates the preparation of two wires. Step 1 shows stripping 4mm of insulation from a red-white (rd-wh) wire (I) and a red-blue (rd-bu) wire (J). Step 2 shows crimping a sleeve onto wire I. Step 3 shows crimping the sleeve onto a connector labeled 14. Step 4 shows crimping the sleeve onto a connector labeled 18. A circular inset shows the crimped sleeve with a checkmark.

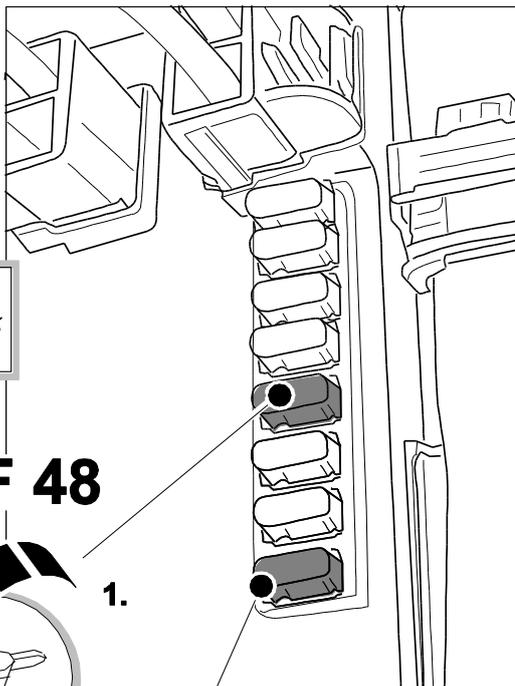
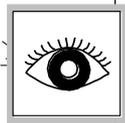
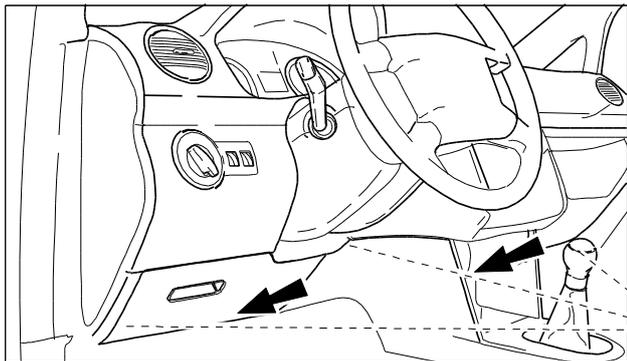

F 48

1.

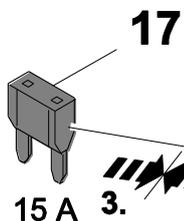

15 A

17

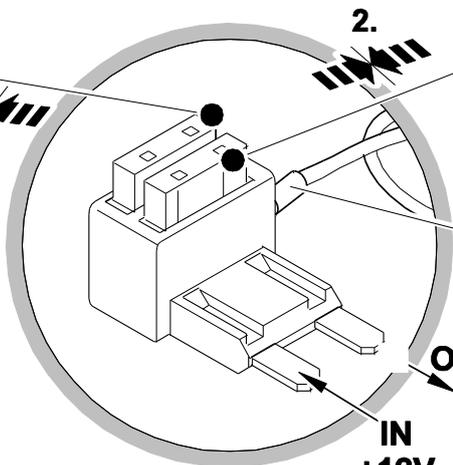

IN +12V

OUT

14

2.

3.

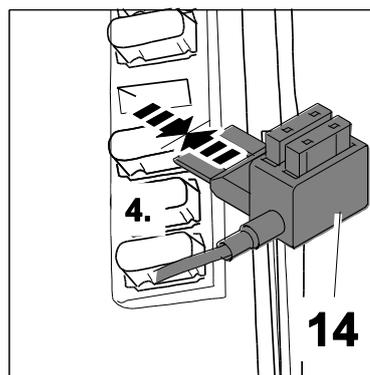
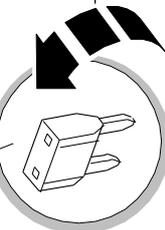

14

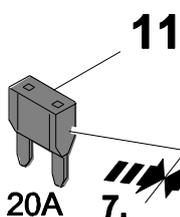

20A

11

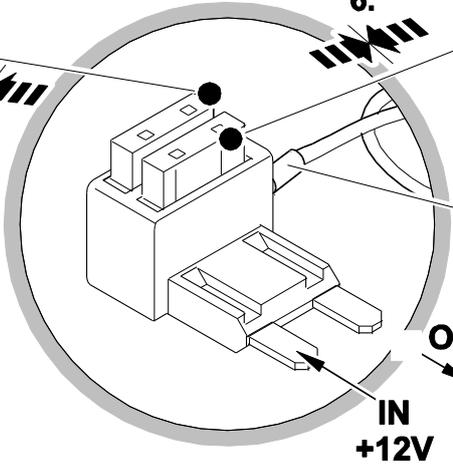

IN +12V

OUT

18

6.

7.

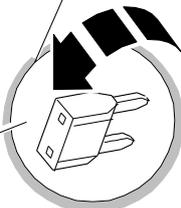

5.

F 33

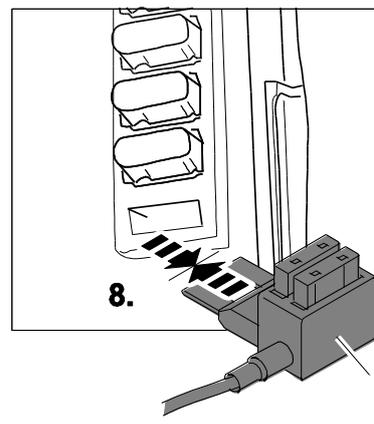

18

**48** OPTIONAL

**764129**

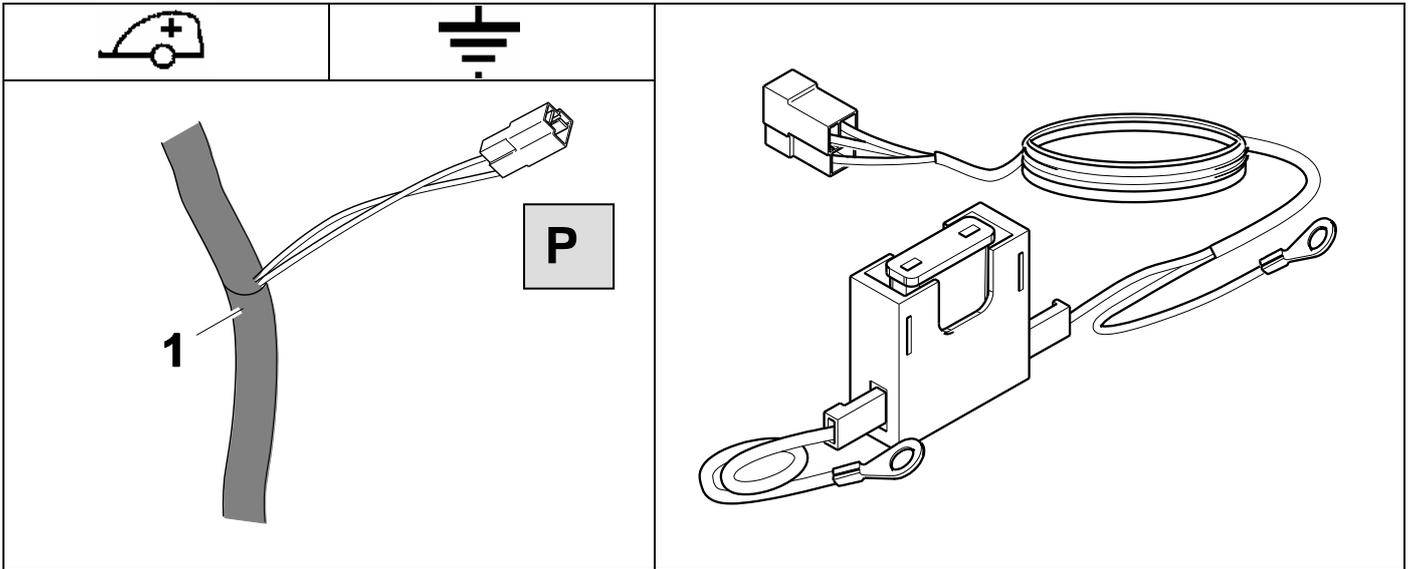

**49** OPTIONAL

**764139**

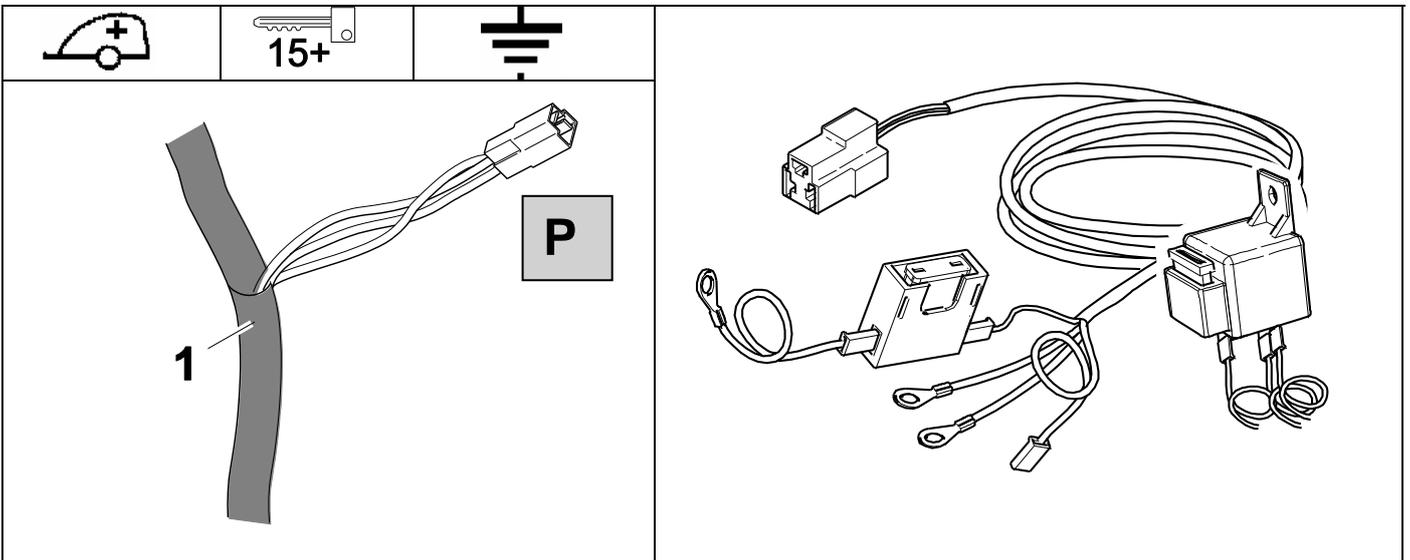

**50** OPTIONAL

**764139**

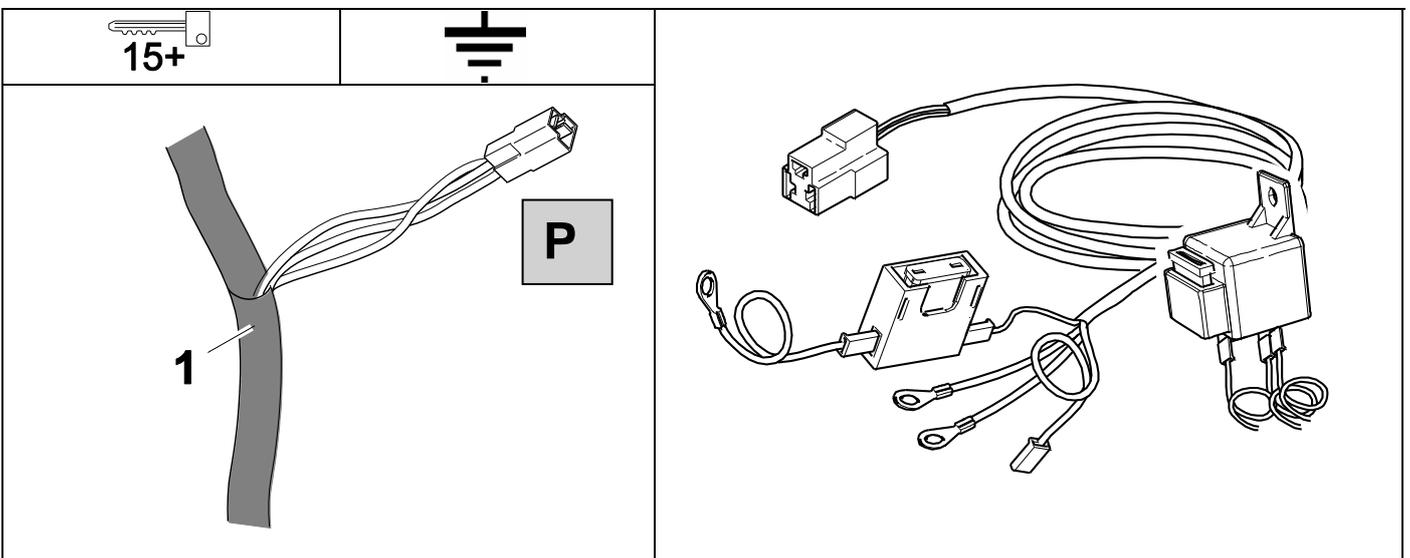

51

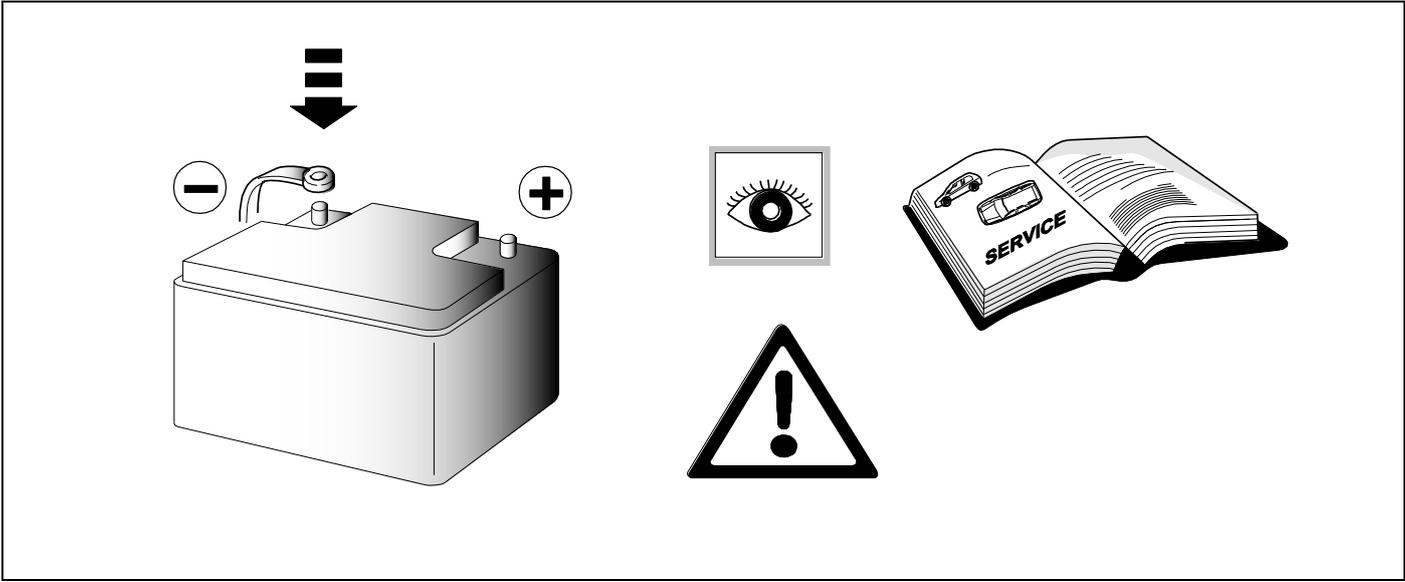

52

CHECK

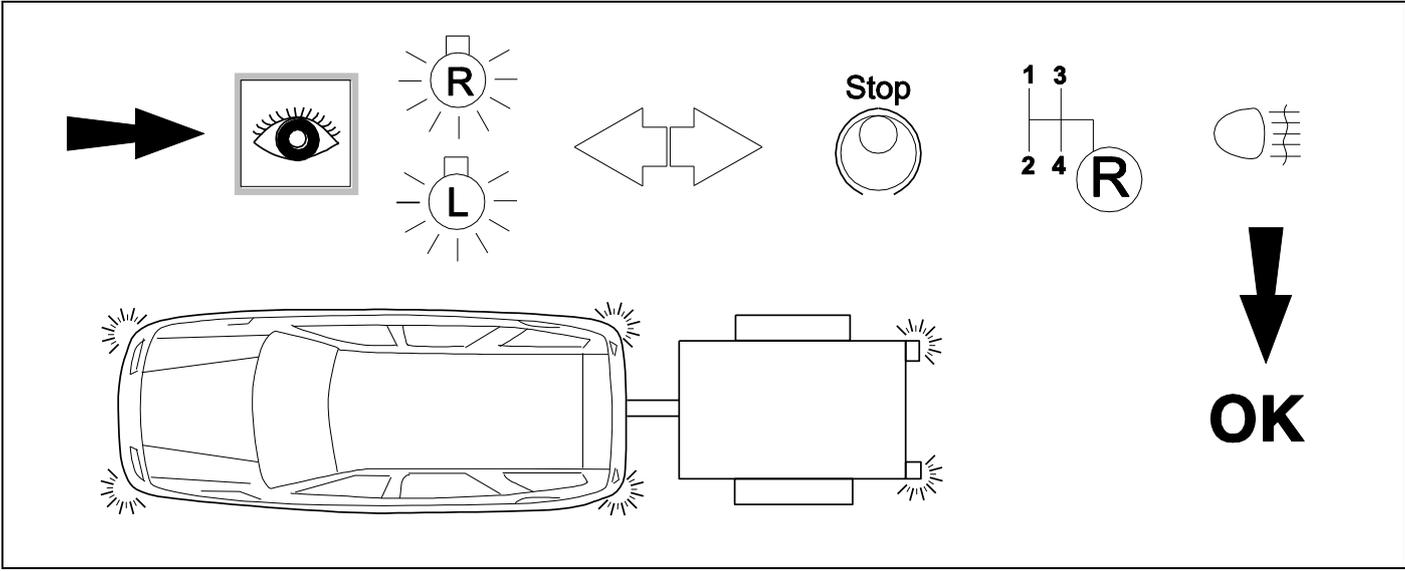

53

CHECK

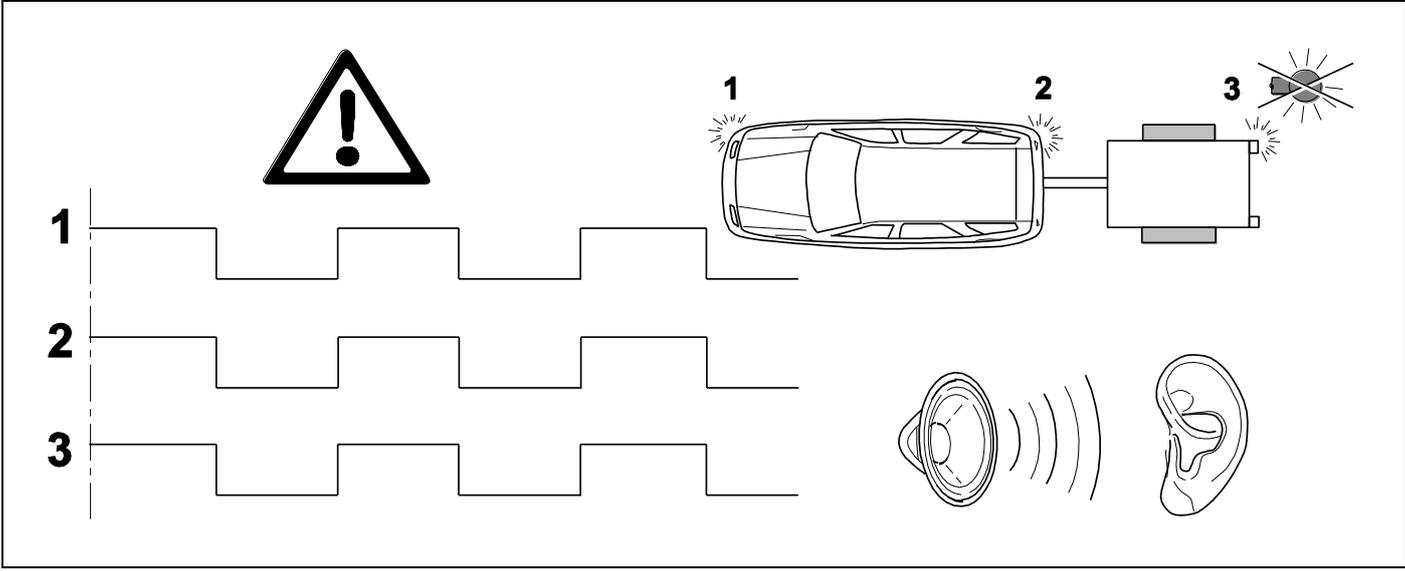

**54** OPTIONAL

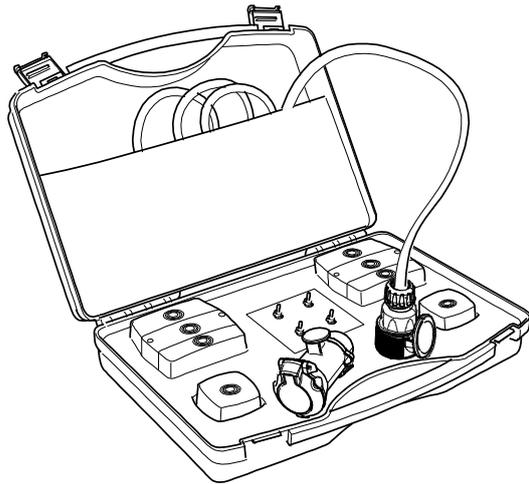

**Trailer Simulator  
for 7p and 13p  
sockets**

**765069**

**55** INFORMATION



**47**

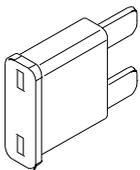

**20 A**

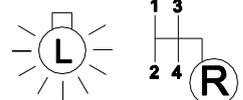
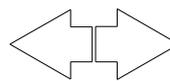
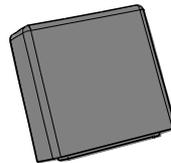
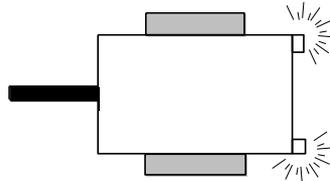

Stop



**56** INFORMATION



**47**

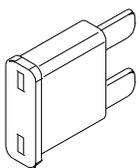

**15 A**

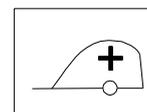
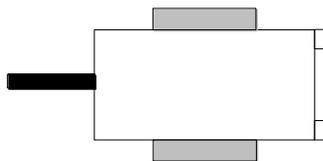

**9**

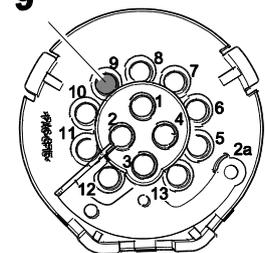

**57** OPTIONAL

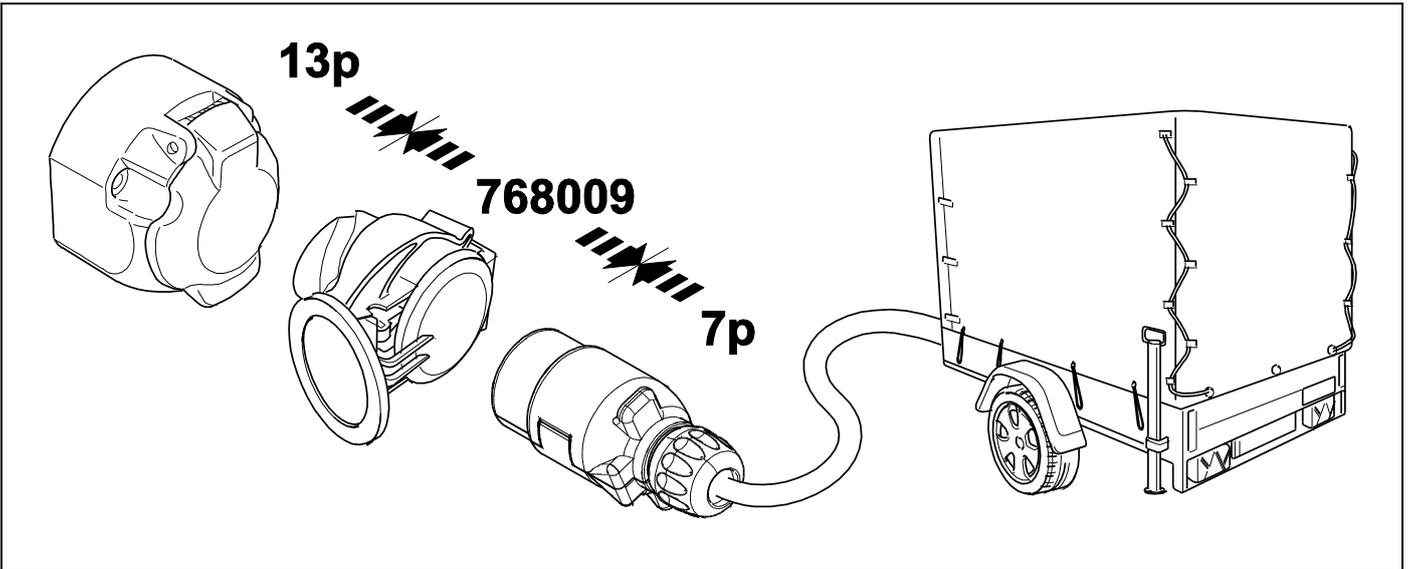

**58** PLEASE NOTICE

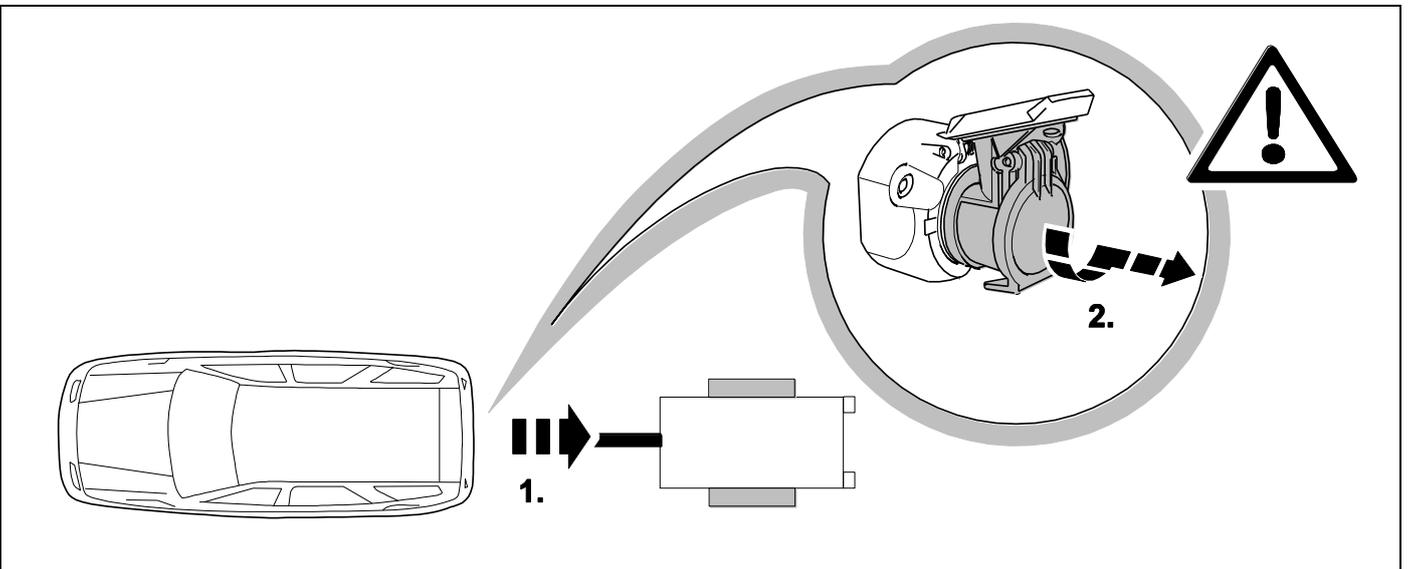

**59**

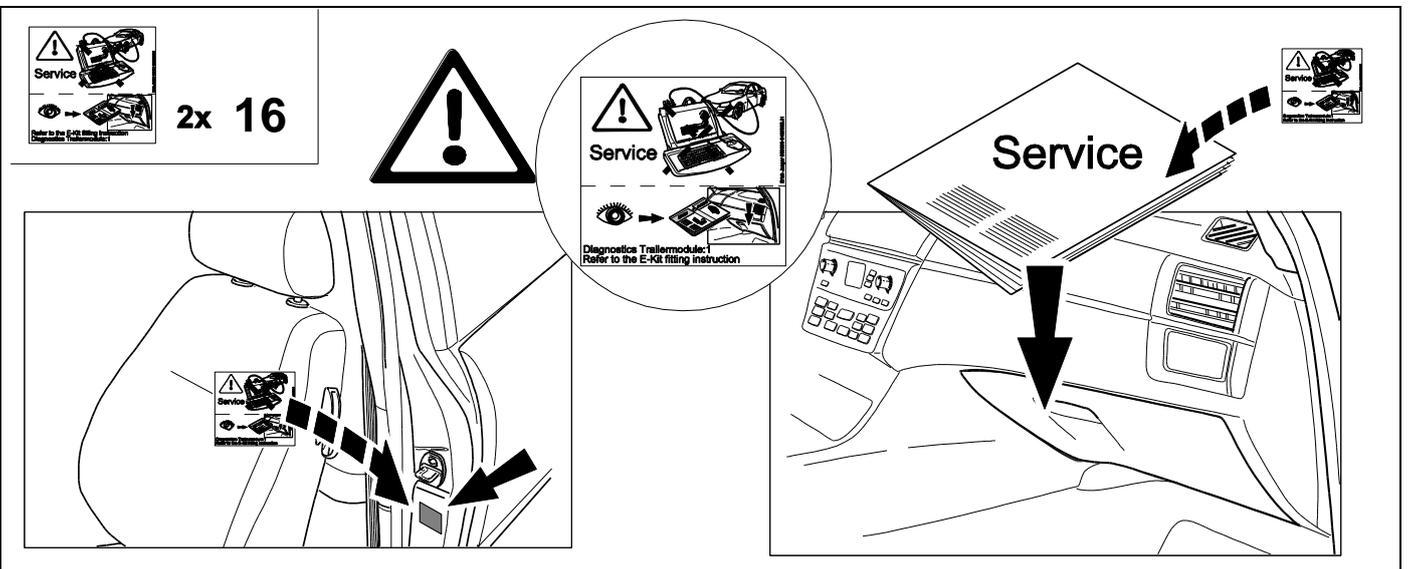



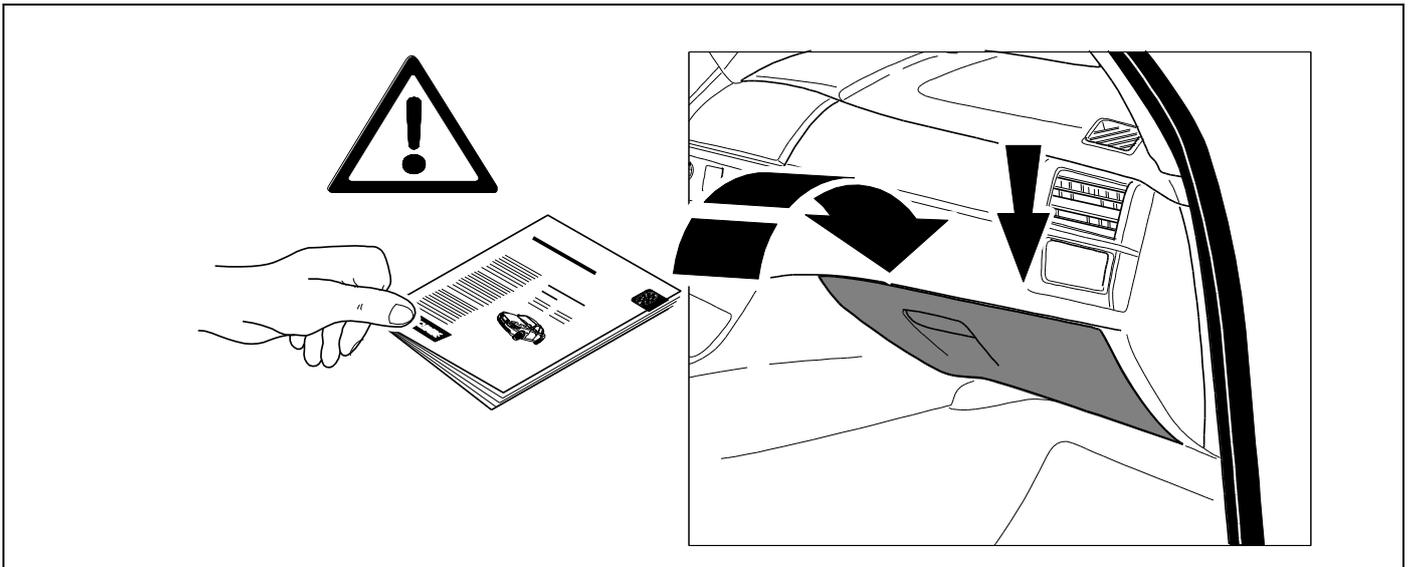

- |   |  |
|---|--|
| <p><b>(D)</b> Änderungen bezüglich Konstruktion, Ausstattung Farbe sowie Irrtum vorbehalten.<br/>Angaben und Abbildungen unverbindlich</p> <p><b>(GB)</b> Subject to change in terms of construction, equipment and colour, and may contain errors.<br/>The information and illustrations are non-binding.</p> <p><b>(F)</b> Sous réserve de modifications de la construction, de l'équipement, de la couleur et sous réserve d'erreurs. Les indications et les illustrations sont sans engagement.</p> <p><b>(NL)</b> Wijzigingen met betrekking tot constructie, uitvoering en kleur evenals vergissingen voorbehouden. Gegevens en afbeeldingen zijn niet bindend.</p> <p><b>(DK)</b> Ændringer med hensyn til konstruktion, udstyr, farver samt fejl forbeholdes.<br/>Oplysninger og illustrationer er uforpligtende.</p> <p><b>(N)</b> Endringer angående konstruksjon, utstyr, farge og feiltagelse forbeholdes.<br/>Oplysninger og illustrasjoner uforbindtlig.</p> <p><b>(S)</b> Med reservation för ändringar vad det gäller konstruktion, utrustning, färg samt för misstag. Uppgifterna och bilderna är inte bindande.</p> <p><b>(FIN)</b> Pidätämme oikeuden rakennetta, varustusta, väriä koskeviin sekä erehdyksestä johtuviin muutoksiin. Tiedot ja kuvat eivät ole sitovia.</p> <p><b>(I)</b> Con riserva di modifiche relative a progettazione, dotazione, colore ed errori.<br/>Le indicazioni e figure sono fornite senza impegno.</p> <p><b>(E)</b> Reservadas las modificaciones respecto a diseño, equipamiento, color, así como error. Indicaciones y figuras sin compromiso.</p> <p><b>(P)</b> Reservamos o direito de alterações relativamente ao desenho, equipamento, cor, bem como de erro. Os dados e as gravuras não implicam compromisso da nossa parte.</p> <p><b>(GR)</b> Διατηρούμε κάθε επιφύλαξη ως προς αλλαγές σε σχέση με κατασκευή, εξοπλισμό, διαρρύθμιση, χρωματισμούς και λάθη παραδρομής.</p> <p><b>(CZ)</b> Změny, týkající se konstrukce, vybavení, barvy, jakož i omyly jsou vyhrazeny.<br/>Údaje a vyobrazení jsou nezávazné.</p> | <p><b>(PL)</b> Zastrzega się prawo do zmian dot. konstrukcji, wykończenia, kolorystyki oraz pomyłek.<br/>Dane i ilustracje niewiążące.</p> <p><b>(TR)</b> Tasarım, donanım ve renk bakımından değişiklik yapma hakkı ve hata ve eksiklik mahfuzdur. Veriler ve resimler bağlayıcı değildir.</p> <p><b>(H)</b> A szerkezet, a kivitell és a szín változtatása, valamint a változások joga fenntartva.<br/>Az adatok és az ábrák nem kötelező érvényűek.</p> <p><b>(HR)</b> Pravo promjena u svezi konstrukcije, opreme, boje kao i zabune oridžavamo.<br/>Podaci i ilustracije su neobavezne.</p> <p><b>(BUL)</b> Запазени права по отношение на конструкцията, обзавеждането, цвета и грешки.<br/>Данните и изображенията не са обвързващи.</p> <p><b>(RO)</b> Ne rezervăm dreptul unor modificări ale construcției, dotării, culorii și dreptul la erori<br/>Datele indicate și imaginile sunt orientative.</p> <p><b>(RU)</b> Права на внесение изменений относительно конструкции, оснащения, окраски, а также на ошибки сохраняются. Данные и иллюстрации имеют примерный характер.</p> <p><b>(LT)</b> Pasiliekaama konstrukcijos, įrangos bei reikmenų, spalvos pakeitimų ir klaidų teisė.<br/>Duomenys ir iliustracijos neįpareigojantys.</p> <p><b>(LV)</b> Tiek paturētas tiesības uz konstrukcijas, iekārtu, krāsu izmaiņām, kā arī kļūdīšanās.<br/>Dati un attēli bez saistībām.</p> <p><b>(EST)</b> Konstruktsiooni, varustuse ja võevi osas muudatused ning eksimine lubatud.<br/>Andmed ja joonised on mittesiduvad.</p> <p><b>(SLO)</b> Zadržana pravica do sprememb glede konstrukcije, opreme, barve ter pomote.<br/>Podatki in slike so neobvezne.</p> <p><b>(SK)</b> Zmeny, ktoré sa týkajú konštrukcie, vybavenia, farby, ako aj omyly sú vyhradené.<br/>Údaje a zobrazenia sú nezáväzné.</p> |
|---|--|