

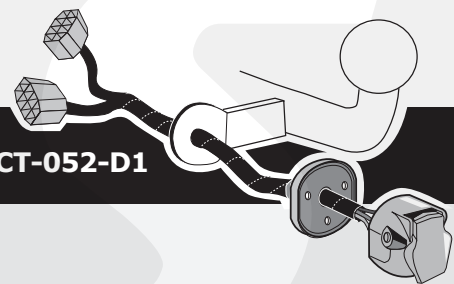

# Citroën C4 Picasso 06/2013- Peugeot 308 HB 10/2013- Peugeot 308 SW 06/2014-



Partnr.: CT-052-D1

**DE** Einbauanleitung Elektrosatz Anhängervorrichtung mit 13-P Steckdose lt. DIN/ISO Norm 11446

**FR** Instructions de montage du faisceau électrique pour crochet d'attelage conforme à la norme DIN/ISO 11446 prise 13-V.

**NL** Montage-handleiding elektrokabelset voor trekhaak met 13-P contactdoos vlg. DIN/ISO norm 11446.

**GB** Fitting instructions electric wiring kit tow bar with 13-P socket up to DIN/ISO Norm 11446.

**ES** Instrucciones de montaje de kit eléctrico para engancho de remolque con caja de conexiones 13-P según norma DIN/ISO 11446.

**IT** Istruzioni di montaggio di set di cavi elettrici per gancio da traino con connettore a 13-P conforme alla norma DIN/ISO 11446.

**SE** Monteringsanvisningar elkabelsats för dragkrok med 13-P kontaktdosa enligt DIN/ISO norm 11446.

**CZ** Montážní pokyny: souprava pro elektrické propojení tažné tyče s 13-P zásuvkou do normy DIN/ISO 11446.

**DK** Monteringsvejledninger for det elektriske ledningsføringssæt for trækstang med 13-N stikdåse, DIN/ISO, norm 11446.

**FI** Ohjeet vetokoukun sähkökaapelisarjan asentamiseen, jossa on DIN/ISO 11446 mukainen 13-N liitin.

**GR** Οδηγίες συναρμολόγησης ηλεκτρικού σετ καλωδίων μπάρας ρυμούλκησης με υποδοχή 13-P μέχρι DIN/ISO Κανόνας 11446.

**NO** Monteringsanviser elkabelsett for trekrok med 13-P koblingsboks ifølge DIN/ISO norm 11446.

**PL** Instrukcje montażu zestawu okablowania elektrycznego dyszla holowniczego z 13-stykowym gniazdem DIN/ISO 11446.

**DE** - Wir weisen ausdrücklich darauf hin, dass eine unsachgemäße und nicht in einer Fachwerkstatt durchgeführte Montage einen Verzicht auf Entschädigung jeglicher Art insbesondere bezüglich des Produkthaftpflichtrechts zur Folge hat

**FR** - Il est expressément prévu qu' on ne saurait se prévaloir d'un quelconque préjudice contractuel ou rédhibitoire si le montage avait été fait en dépit des dites instructions ou dans un garage ne disposant pas des équipements adéquats.

**NL** - Wij wijzen er met nadruk op, dat ondeskundige en niet door een vakkundige werkplaats uitgevoerde montage tot gevolg heeft dat daardoor ieder recht op schadevergoeding, ook op wettelijke aansprakelijkheid inzake producten, vervalt.

**GB** - We would expressly point out that assembly not carried out properly by a competent installer will result in cancellation of any right to damage compensation, in particular those arising by virtue of the product liability act.

**ES** - El montaje inapropiado y efectuado por personal no cualificado originará la pérdida de todo derecho a indemnización o la expiración de toda responsabilidad civil con respecto al producto.

**IT** - Sottolineiamo espressamente che un montaggio inadeguato ed eseguito da un'officina non specializzata ha come conseguenza il decadere di qualsiasi diritto al risarcimento danni, nonché alla responsabilità legale relativa ai prodotti.

**SE** - Vi påpekar med eftertryck att all rätt till skadeersättning och all laglig ansvarighet förfaller om monteringen inte har utförts på rätt sätt och av en professionell verkstad.

**CZ** - Výslovně zdůrazňujeme, že jakákoli montáž, která není provedená ve specializované dílně, má za následek odvolání nároků na kompenzaci jakéhokoliv druhu, obzvláště vyplývajících ze zákona o odpovědnosti za způsobené škody.

**DK** - Vi ønsker at gøre udtrykkeligt opmærksom på at forkert samling, der ikke er udført af et specialiseret værksted, resulterer i bortfaldelse af kompenseringskrav af alle slags, i særdeles krav der måtte opstå omkring det lovpligtige ansvar.

**FI** - Korostamme, että kaikki oikeudet vahinkokorvaukseen kuten myös valmistajan laillinen vastuu raukeavat, mikäli asennusta ei ole toteutettu oikealla tavalla eikä ammattitaitoisen asiantuntijan toimesta.

**GR** - Επισημαίνουμε κατηγορηματικά ότι οποιαδήποτε εσφαλμένη συναρμολόγηση, η οποία δεν έχει πραγματοποιηθεί ειδικό εργαστήριο θα οδηγήσει σε απώλιση των αξιώσεων επιβολής αποζημιώσεων οποιαδήποτε είδους, ειδικά όσα προκύπτουν από το νόμο ευθύνης προϊόντων.

**NO** - Vi påpeker ettertrykkelig at all rett til skadeerstatning og rettslig ansvar forfaller dersom monteringen ikke er blitt utført på riktig måte og av et profesjonelt verksted.

**PL** - Chcielibyśmy wyraźnie zaznaczyć, iż wszelki nieprawidłowy montaż, który nie jest wykonywany w specjalistycznym warsztacie pociąga za sobą utratę możliwości dochodzenia wszelkiego typu roszczeń, w szczególności tych wynikających z odpowiedzialności producenta za swój produkt.

- Technische Änderungen vorbehalten.  
- Widerstand nur gemäß der Tabelle auf dem Anhänger verwenden.

- Sous réserve de modifications techniques.  
- Ne excédez pas la charge maximale, indiquée dans le tableau.

- Technische wijzigingen voorbehouden.  
- Gebruik alleen belasting volgens aansluittabel op het getrokken voertuig.

- Contents of these kits and their fitting manuals are subject to alteration without notice, please ensure that these instructions are read and fully understood before commencing installation.  
- Do not overload circuits; the maximum loads per connection are detailed in this manual.

- Nos reservamos el derecho a efectuar modificaciones técnicas.  
- Utilice sólo cargas de acuerdo a la tabla de conexión del vehículo remolcado.

- Ci si riserva il diritto di apportare modifiche tecniche.  
- Utilizzare esclusivamente un carico conforme alla tabella degli allacci relativa al veicolo in questione.

- Tekniska ändringar förbehålles.  
- Använd endast belastning enligt anslutningstabellen på det dragna fordonet.

- Změny mohou být provedeny bez oznámení.  
- Používejte pouze při maximálním nabití podle tabulky na tažném vozidle.

- Kan ændres uden varsel.  
- Brug kun den maksimale belastning, i overensstemmelse med forbindelsestabelen for bugserede køretøjer.

- Oikeus teknisiin muutoksiin ilman erillistä huomautusta pidetään.  
- Kuormita työvirtapiiriä ainoastaan hinattavan ajoneuvon kytkentäkaavion mukaisesti.

- Μπορεί να τροποποιηθεί χωρίς προηγούμενη ειδοποίηση.  
- Χρησιμοποιείτε μόνο μέγιστο ηλεκτρικό φορτίο σύμφωνα με τον πίνακα σύνδεσης στο ρυμούλκούμενο όχημα.

- Tekniske endringer forbeholdes. - Overskrid ikke grensene anviset i tilkoblingstabellen på tilhengeren eller det tilkoblede kjøretøyet.

- Podlega zmianom bez powiadomienia.  
- Używać tylko takiego maksymalnego obciążenia które wynika z tabliczki połączeń holowanego pojazdu.

Einzelteilliste

Liste de pièces

Onderdelenlijst

Part list

Lista de componentes

Elenco componenti

Dellista

Seznam dílů

Del-liste

Osaluettelo

Κατάλογος εξαρτημάτων

Delliste

Lista części

(DE)

(FR)

(NL)

(GB)

(ES)

(IT)

(SE)

(CZ)

(DK)

(FI)

(GR)

(NO)

(PL)

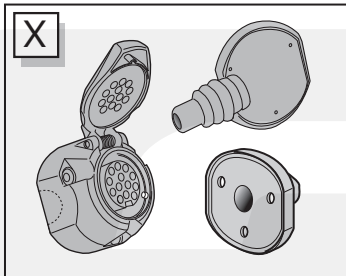
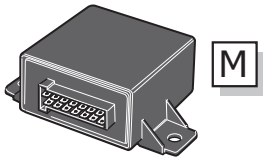
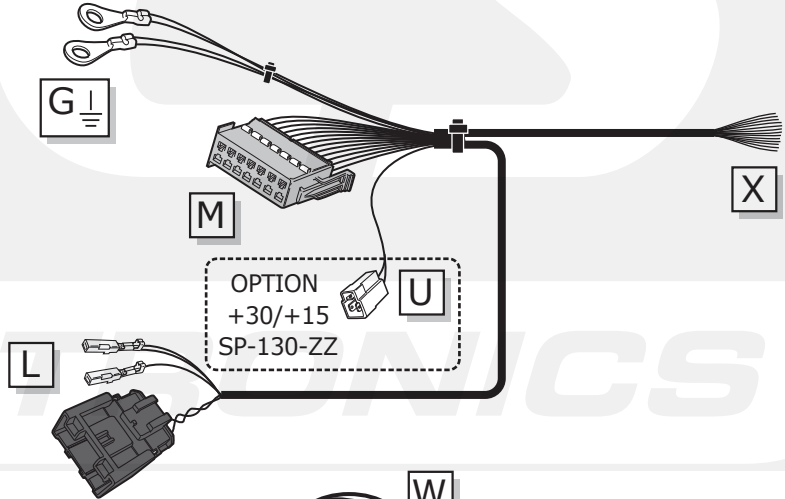
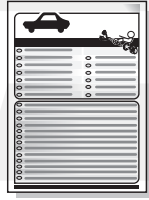

**\* OPTION +30/+15**  
 vorbereitung für  
 préparation pour  
 voorbereiding voor  
 preparación para  
 preparazione per  
 förberedelse för  
 příprava pro  
 förberedelse for  
 Προετοιμασία για  
 przygotowanie do

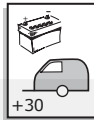

|                     |                       |
|---------------------|-----------------------|
| (DE) Braun/Weiß     | (CZ) Hnědo/Bílá       |
| (FR) Marron/Blanc   | (DK) Brun/Hvid        |
| (NL) Bruin/Wit      | (FI) Ruskea/Valkoinen |
| (GB) Brown/White    | (GR) Καφέ/Λευκό       |
| (ES) Marrón/Blanco  | (NO) Brun/Hvit        |
| (IT) Marrone/Bianco | (PL) Brązowy/Biały    |
| (SE) Brun/Vit       |                       |
| (DE) Rot            | (CZ) Červená          |
| (FR) Rouge          | (DK) Rød              |
| (NL) Rood           | (FI) Punainen         |
| (GB) Red            | (GR) Κόκκινο          |
| (ES) Rojo           | (NO) Rød              |
| (IT) Rosso          | (PL) Czerwony         |
| (SE) Röd            |                       |

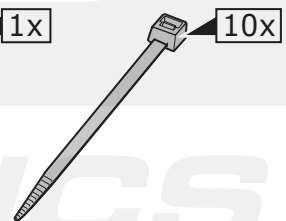
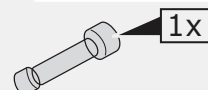
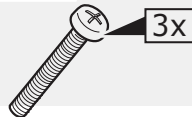
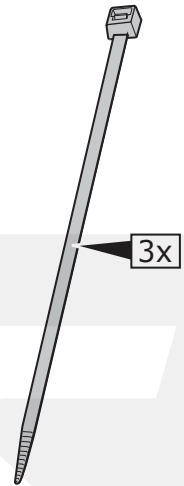

**INFO**

|    | BK      | BN      | BU        | GY     | GN      | WH        | YE        | OG           | PE        | PI              | RD       | NL              | BG     |
|----|---------|---------|-----------|--------|---------|-----------|-----------|--------------|-----------|-----------------|----------|-----------------|--------|
| DE | Schwarz | Braun   | Blau      | Grau   | Grün    | Weiß      | Gelb      | Orange       | Violett   | Rosa            | Rot      | Naturfarben     | Beige  |
| FR | Noir    | Marron  | Bleu      | Gris   | Vert    | Blanc     | Jaune     | Orange       | Violet    | Rose            | Rouge    | Nature          | Beige  |
| NL | Zwart   | Bruin   | Blauw     | Grijs  | Groen   | Wit       | Geel      | Oranje       | Paars     | Roze            | Rood     | Naturel         | Beige  |
| GB | Black   | Brown   | Blue      | Grey   | Green   | White     | Yellow    | Orange       | Purple    | Pink            | Red      | Natural colour  | Beige  |
| ES | Negro   | Marrón  | Azul      | Gris   | Verde   | Blanco    | Amarillo  | Naranja      | Morado    | Rosa            | Rojo     | Color natural   | Beige  |
| IT | Nero    | Marrone | Blu       | Grigio | Verde   | Bianco    | Giallo    | Arancione    | Viola     | Rosa            | Rosso    | Colori naturali | Beige  |
| SE | Svart   | Brun    | Blå       | Grå    | Grön    | Vit       | Gul       | Orange       | Lila      | Rosa            | Röd      | Naturfärger     | Beige  |
| CZ | Černá   | Hnědá   | Modrá     | Šedá   | Zelená  | Bílá      | Žlutá     | Oranžová     | Fialová   | Růžová          | Červená  | Přírodní        | Béžový |
| DK | Sort    | Brun    | Blå       | Grå    | Grøn    | Hvid      | Gul       | Orange       | Lilla     | Pink            | Rød      | Naturfarvet     | Beige  |
| FI | Musta   | Ruskea  | Sininen   | Harmaa | Vihreä  | Valkoinen | Keltainen | Oranssi      | Purppura  | Vaaleanpunainen | Punainen | Luonnonväri     | Beige  |
| GR | Μαύρο   | Καφέ    | Μπλε      | Γκρι   | Πράσινο | Λευκό     | Κίτρινο   | Πορτοκαλί    | Μοβ       | Ροζ             | Κόκκινο  | Φυσικά χρώματα  | μπεζ   |
| NO | Svart   | Brun    | Blå       | Grå    | Grønn   | Hvit      | Gul       | Oransje      | Lilla     | Rosa            | Rød      | Naturfarger     | Beige  |
| PL | Czarny  | Brązowy | Niebieski | Szary  | Zielony | Biały     | Żółty     | Pomarańczowy | Purpurowy | Różowy          | Czerwony | Barwy           | beżowy |

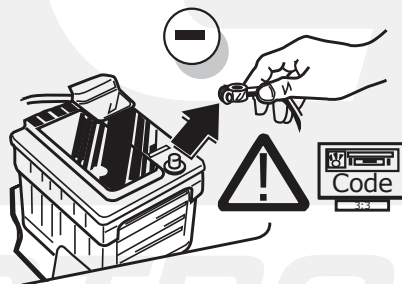
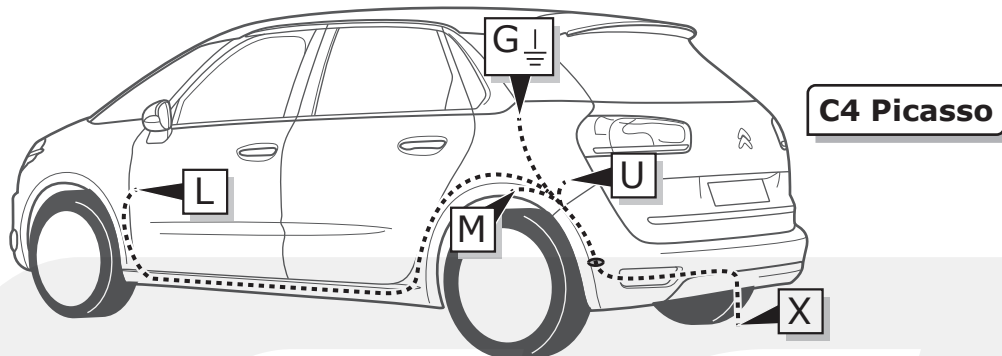
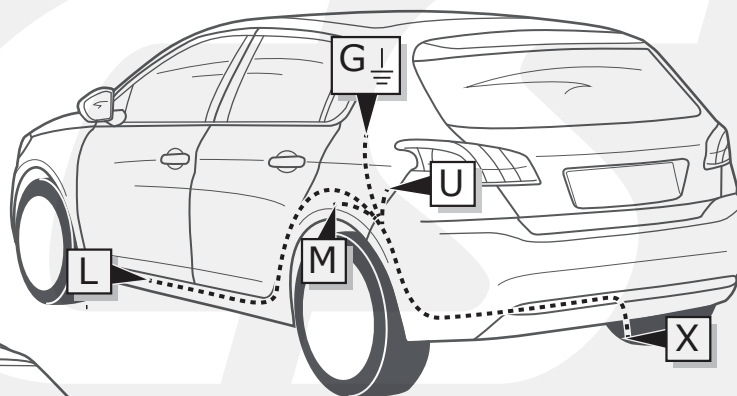
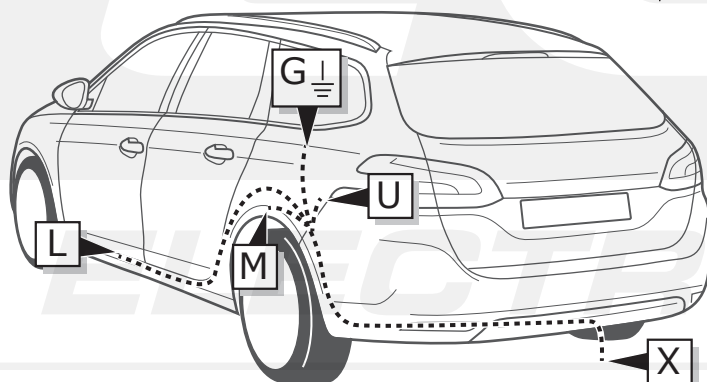
**INFO**

**ROUTING**

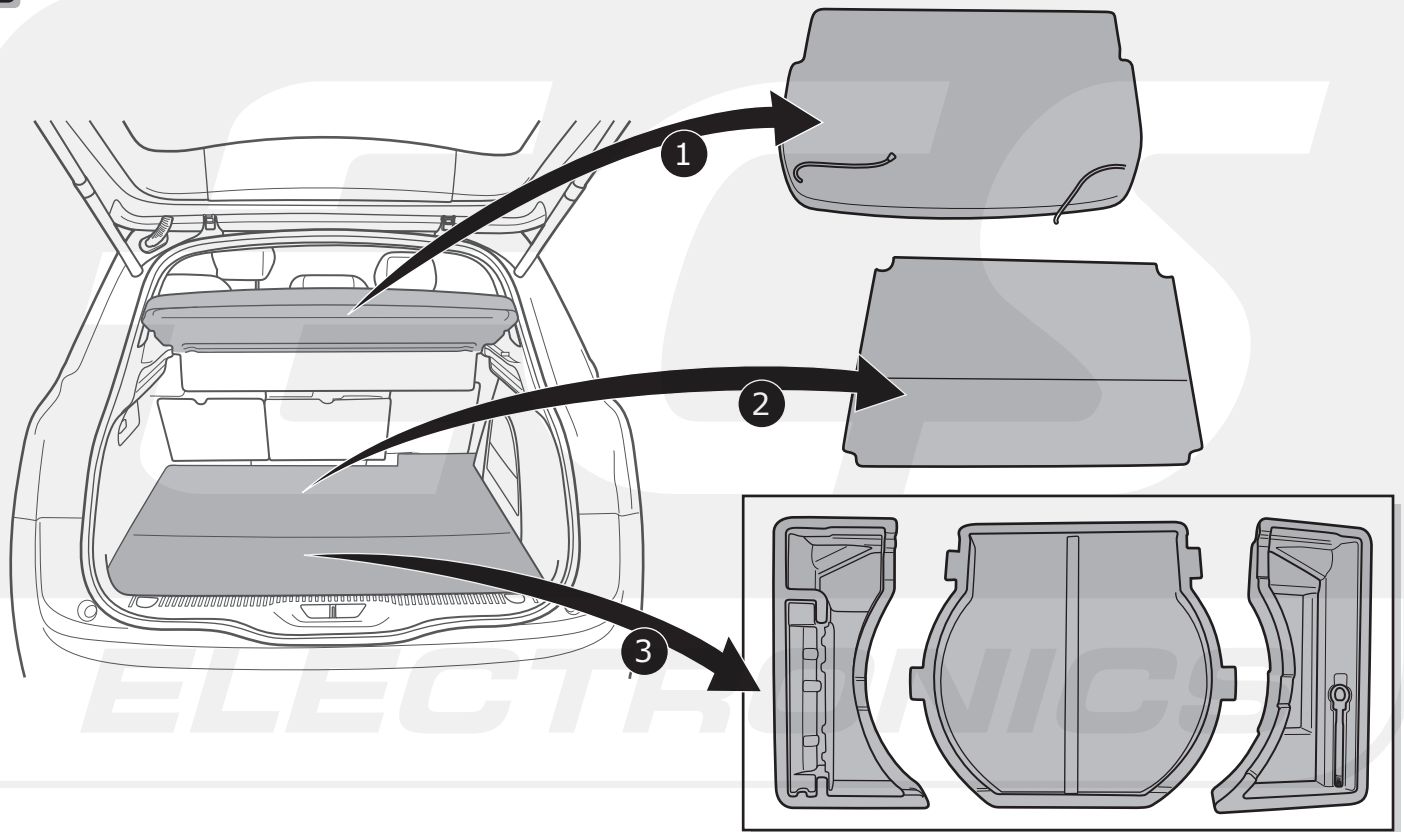
**308 HB**

**308 SW**

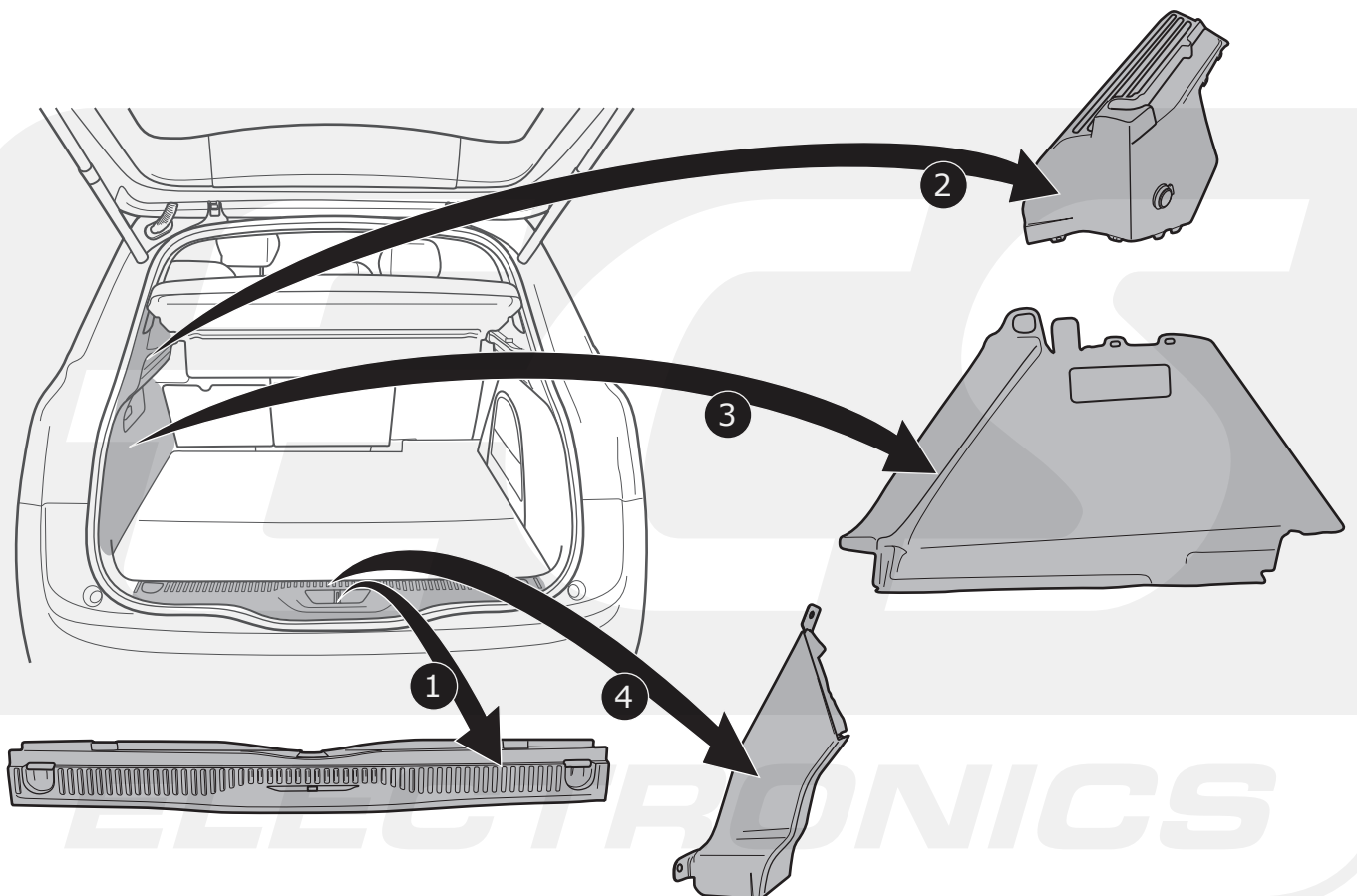
1



2



308 HB

3

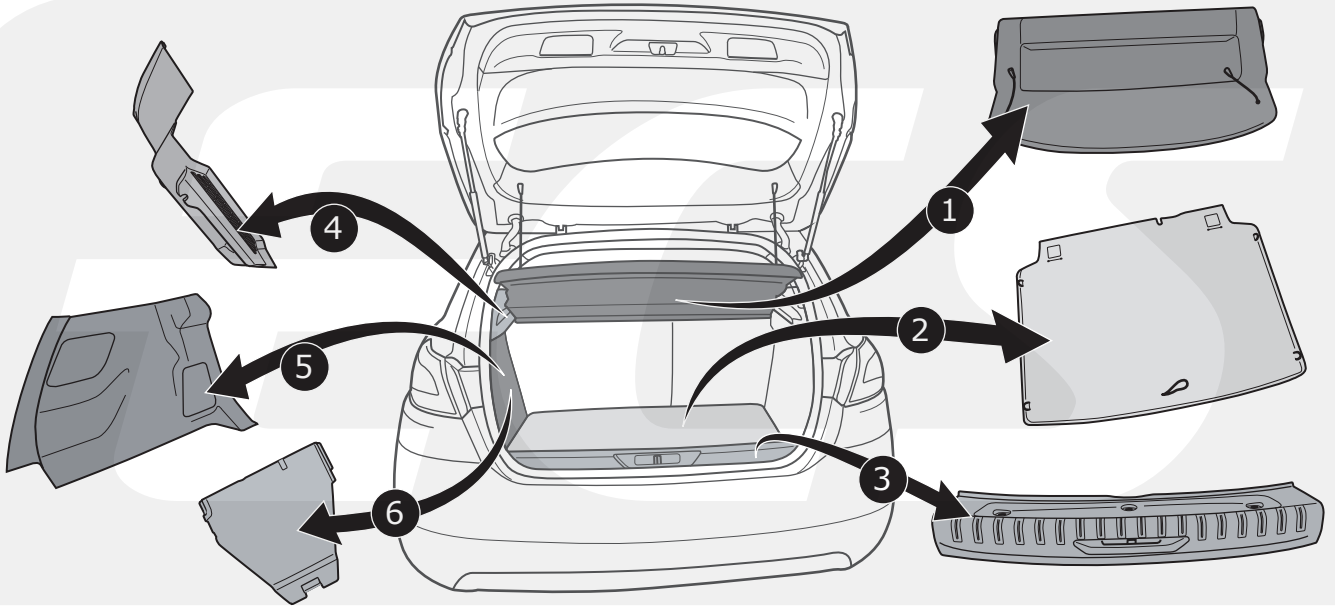

308 SW

4

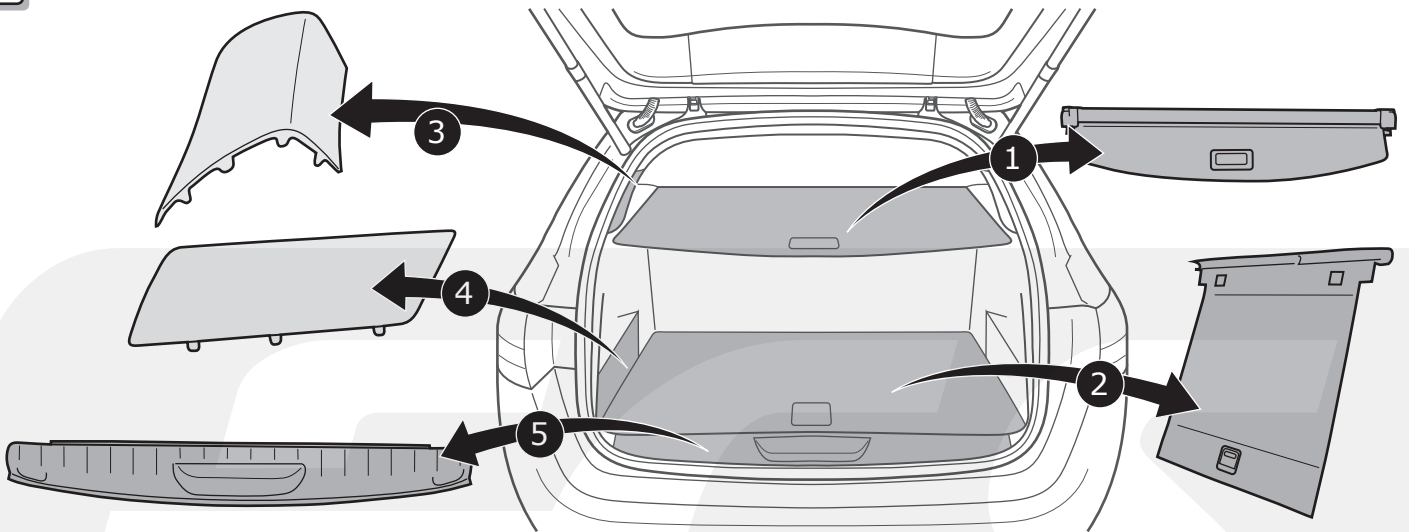

5

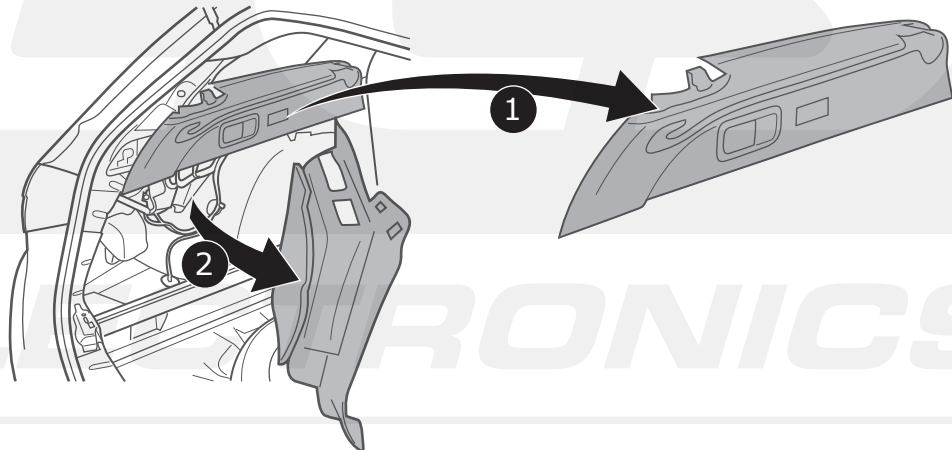



6

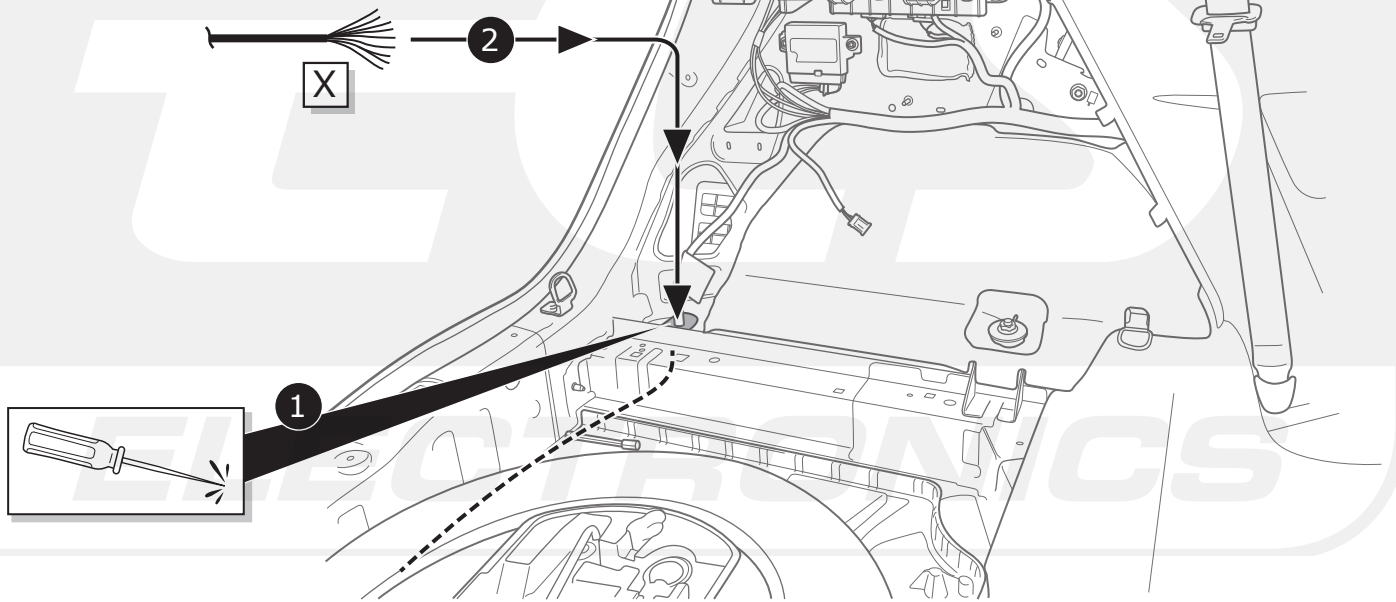
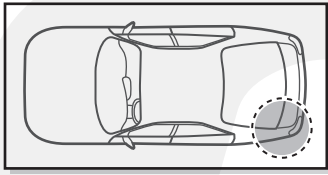

7

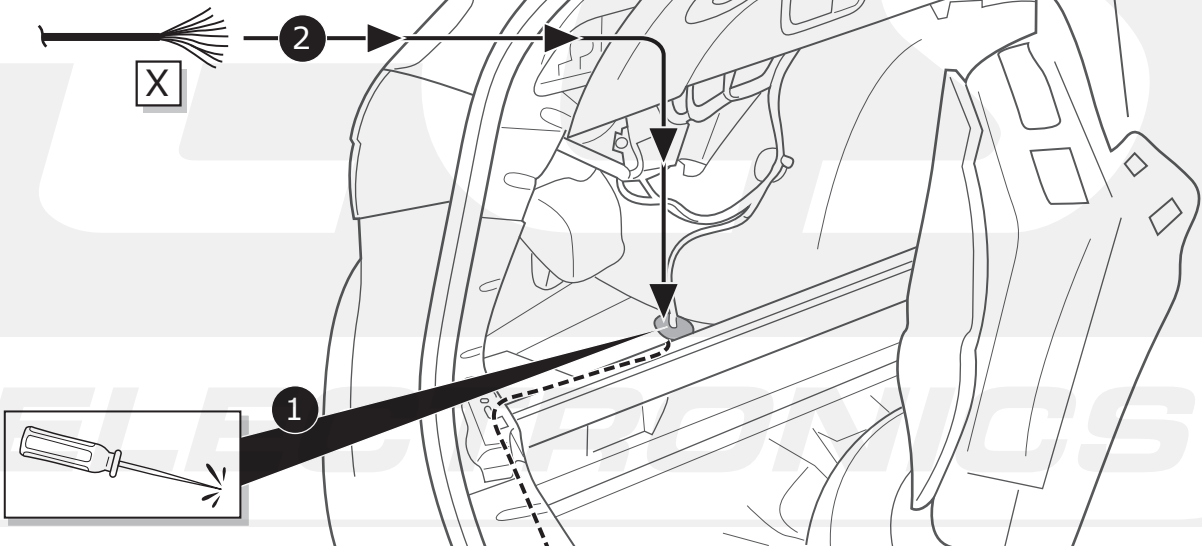
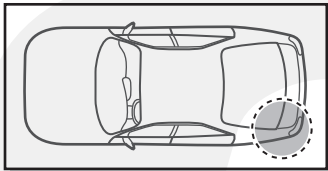

# All models

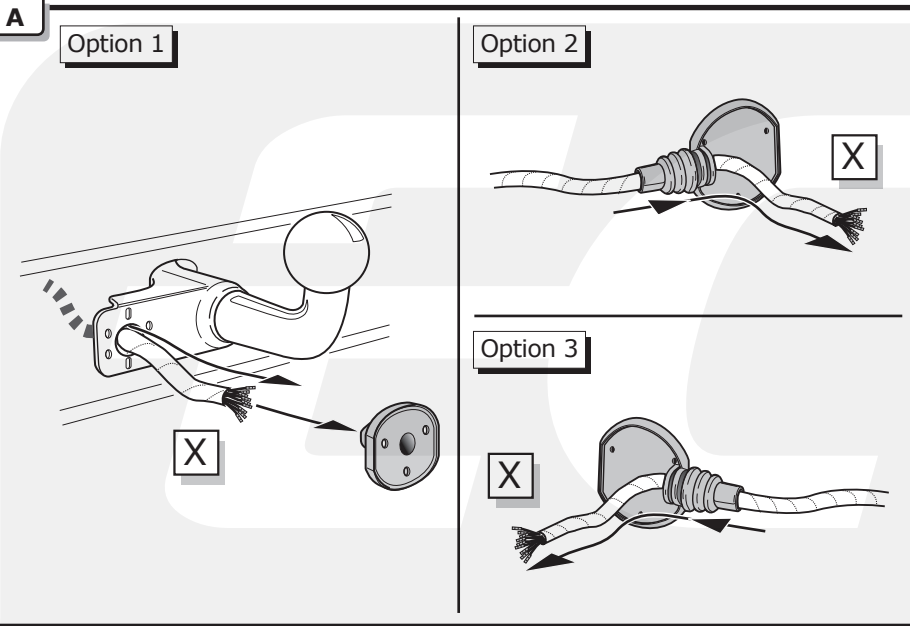

**INFO**

- (DE) Anschluss Steckdose
- (FR) Connection de la prise
- (NL) Contactdoos aansluiting
- (GB) Socket connection
- (ES) Conexión de la caja de enchufe
- (IT) Allaccio zoccolo
- (SE) Anslutning kontaktdosa
- (CZ) Objímkový konektor
- (DK) Stikdåse forbindelse
- (FI) Pistorasia liitäntä
- (GR) Υποδοχή σύνδεσης
- (NO) Tilkobling koblingsboks
- (PL) Połączenie przez gniazdo

**Pag. 15**

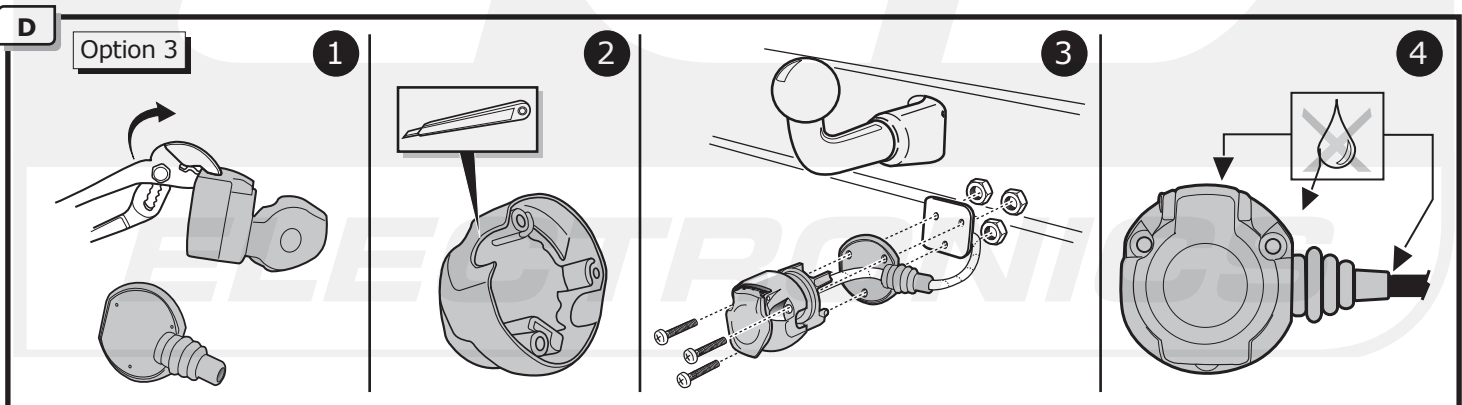
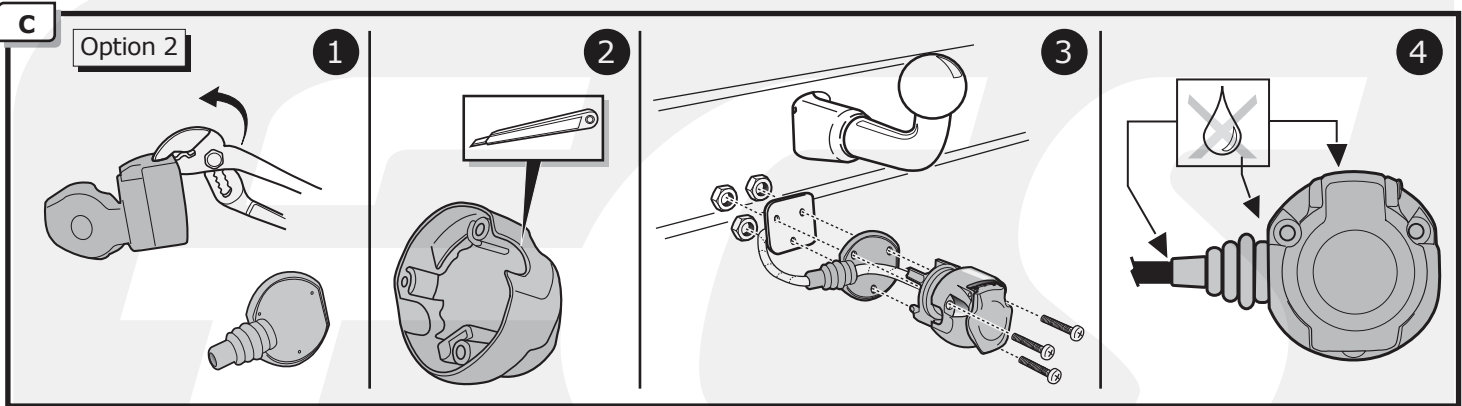
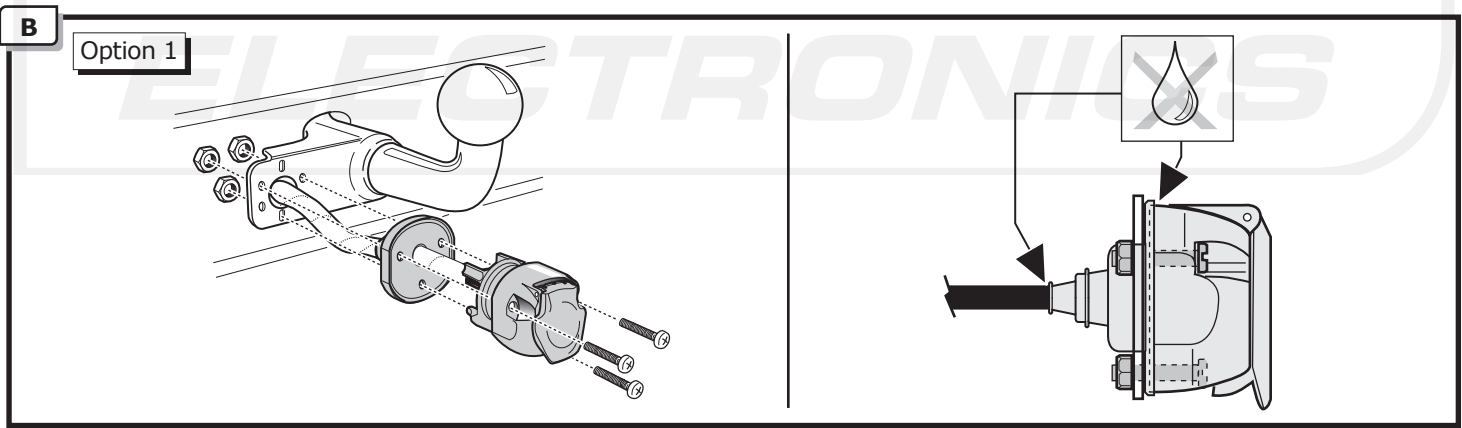

# C4 Picasso / 308 HB

8

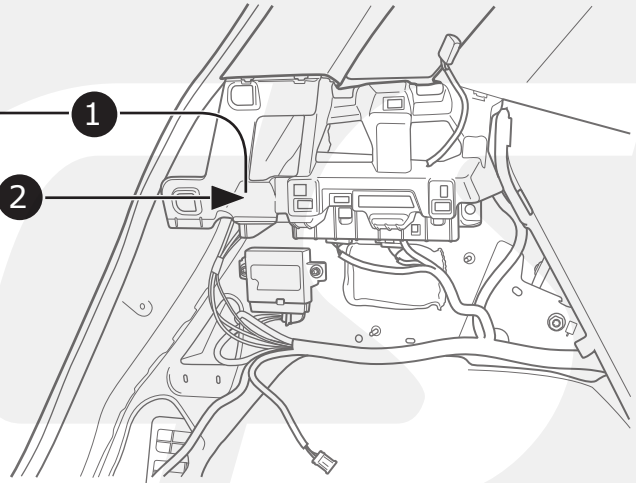
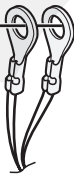
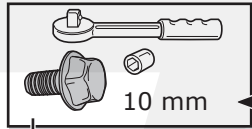
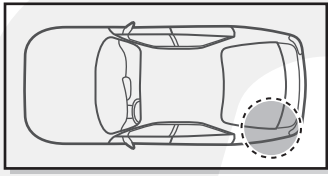

# 308 SW

9

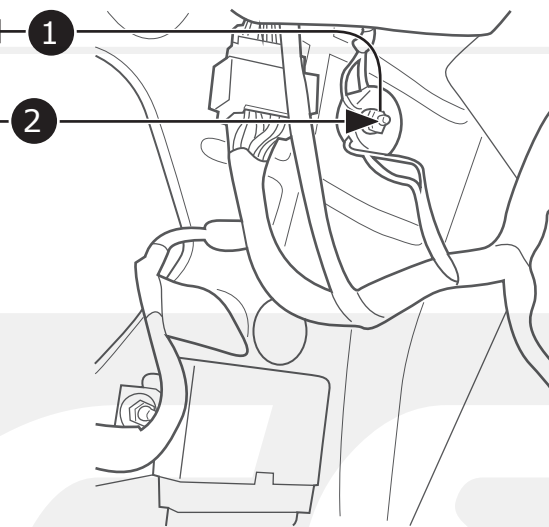
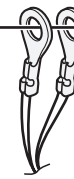
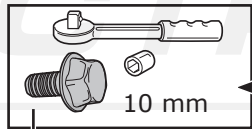
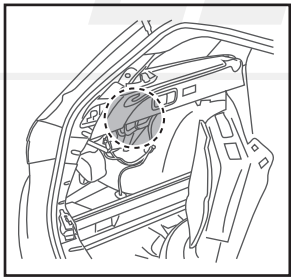

# All models

10

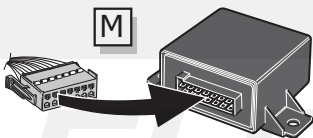

1

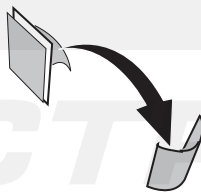

2

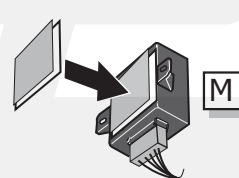

3

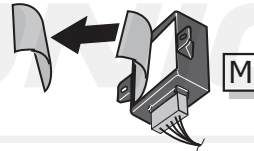

4

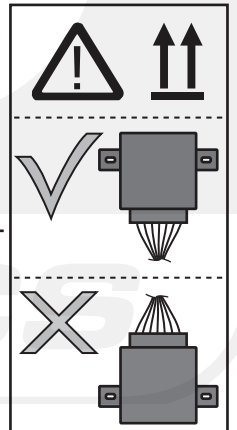



# C4 Picasso

11

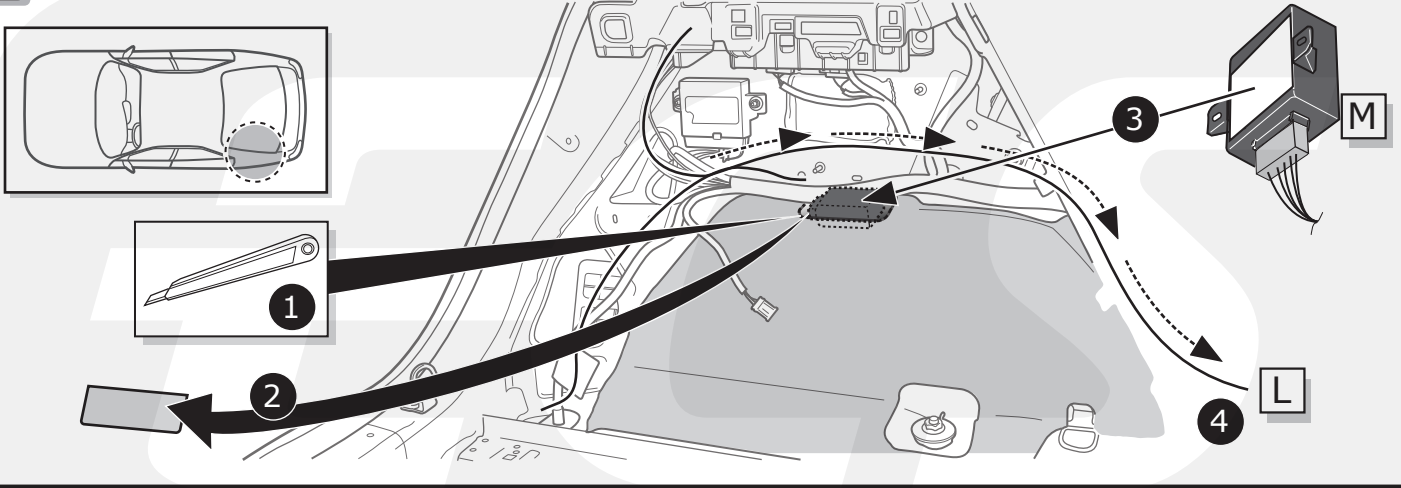

# 308 HB

12

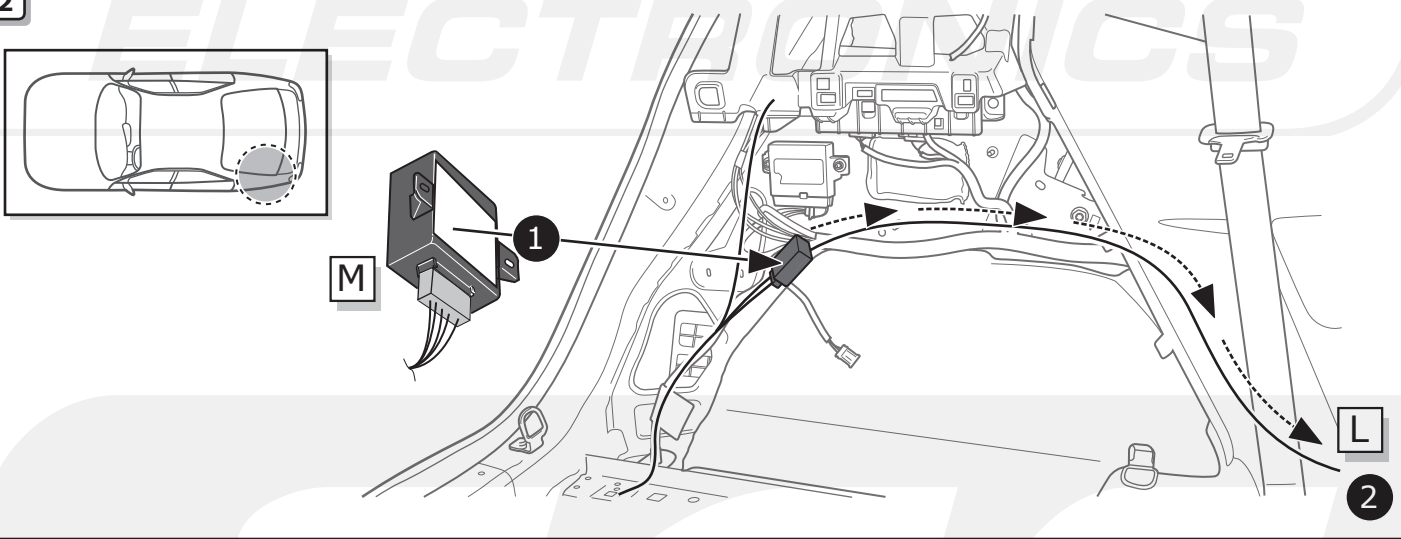

# 308 SW

13

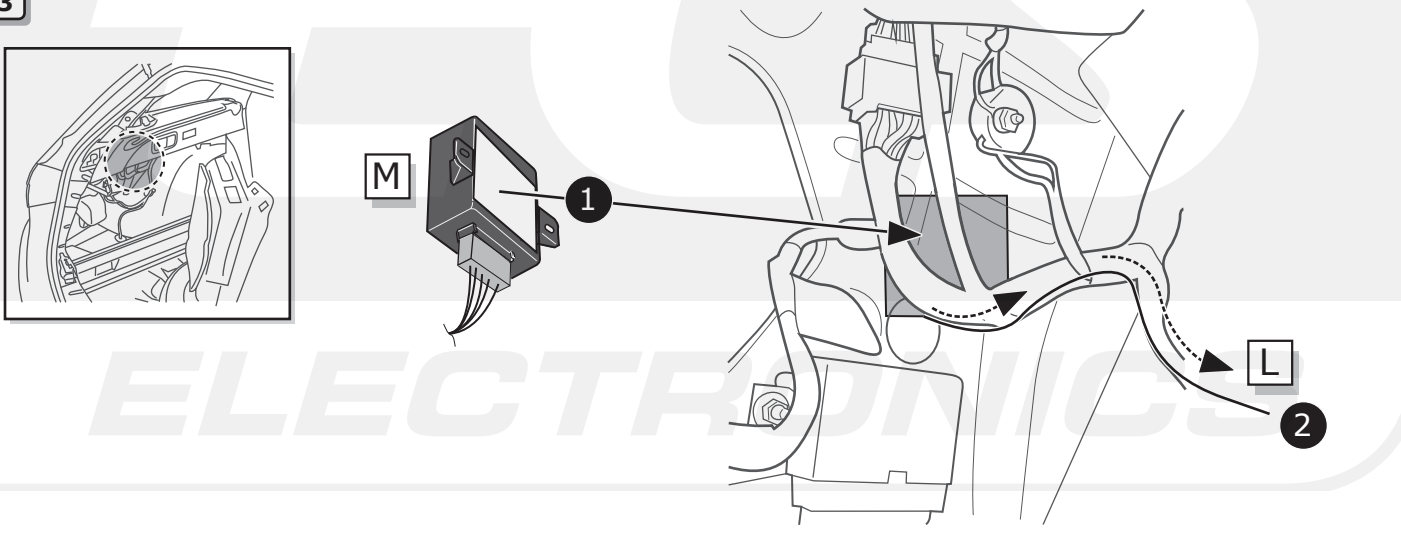

## C4 Picasso

### ROUTING

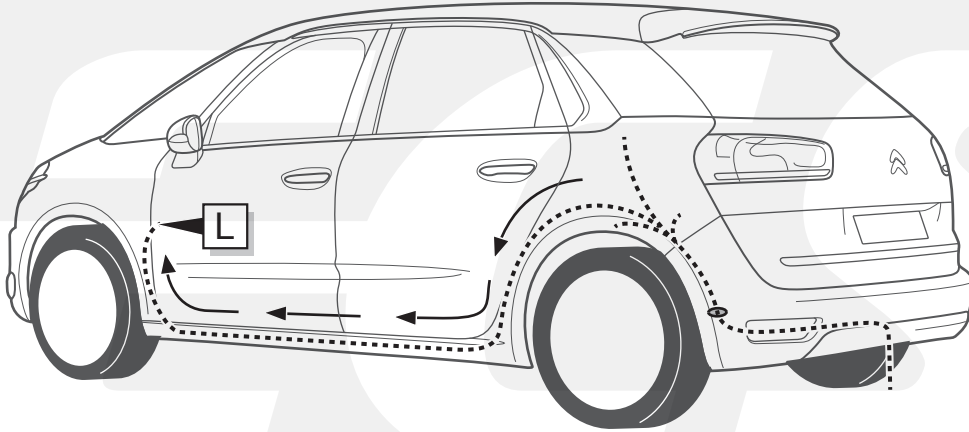

## 308 HB

### ROUTING

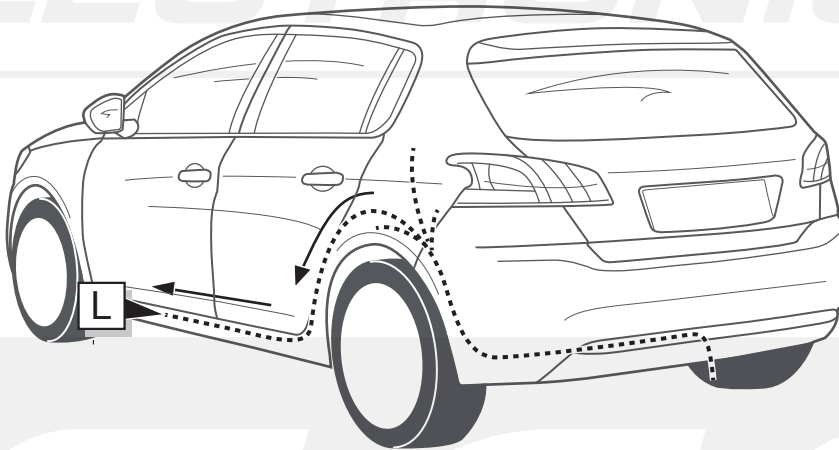

## 308 SW

### ROUTING

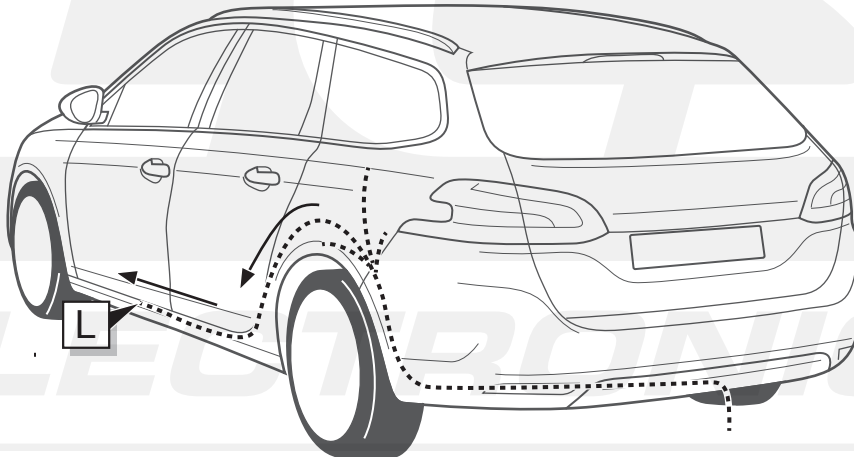

14

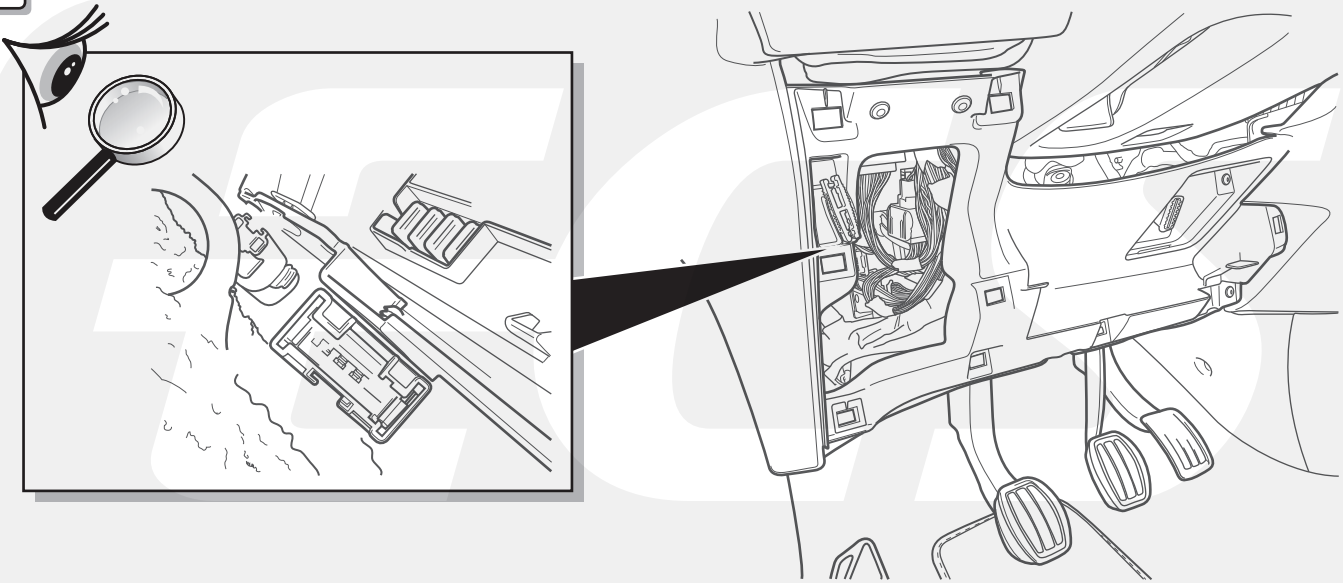

308 HB / 308 SW

15

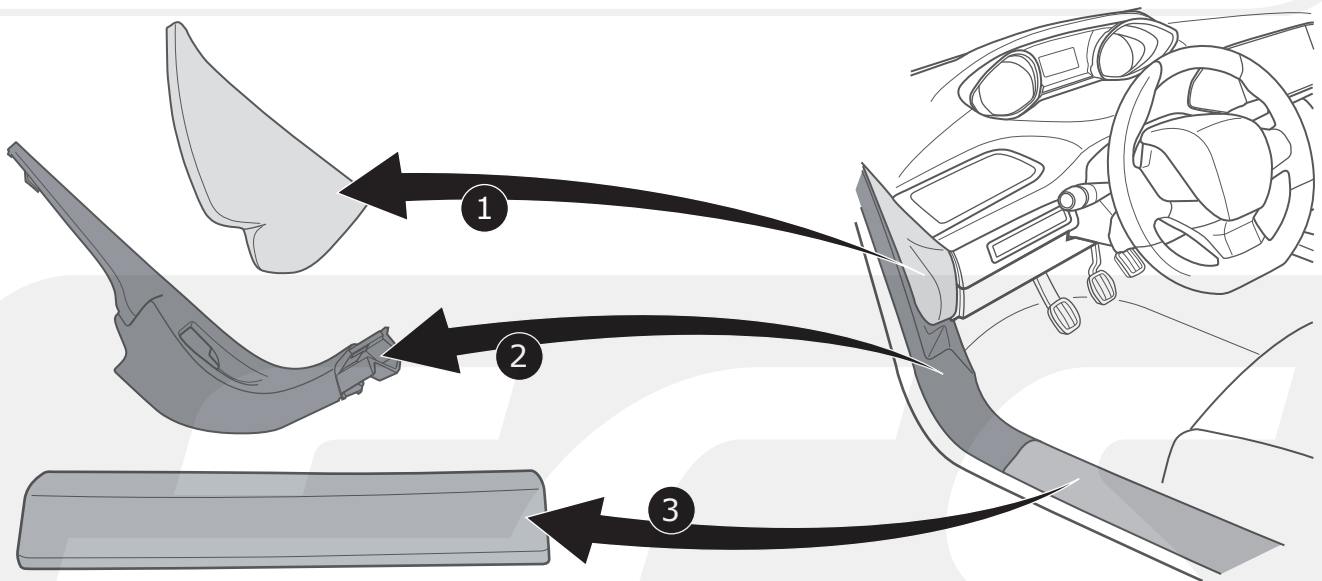

16

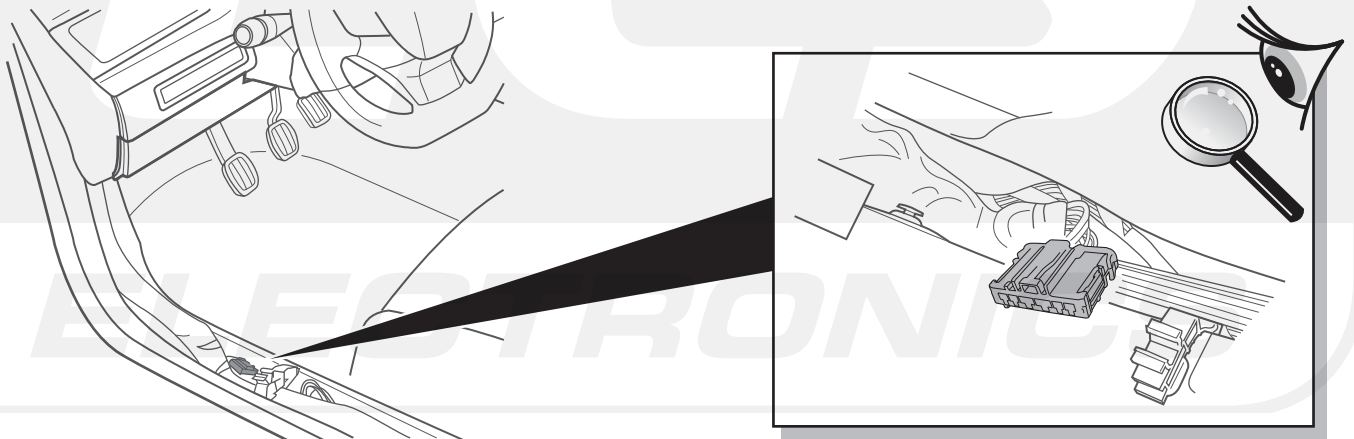

17

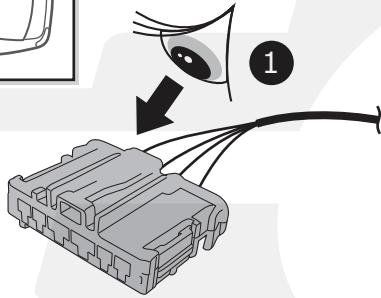
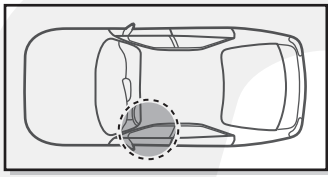

54 STOP

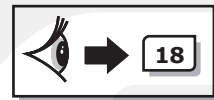
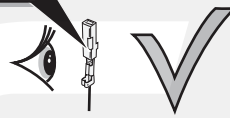

54 STOP

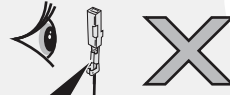

|  |                             |
|--|-----------------------------|
|  | 54 STOP .....               |
|  | +30 (5 <sup>2</sup> ) ..... |

18

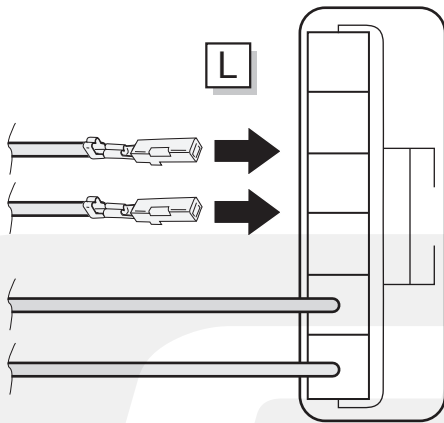

|   |                       |         |
|---|-----------------------|---------|
| L | 54 STOP               | BU / RD |
| L | +30 (5 <sup>2</sup> ) | OG      |

19

|          |          |          |          |
|----------|----------|----------|----------|
| <p>1</p> | <p>2</p> | <p>3</p> | <p>5</p> |
|          |          | <p>4</p> |          |

20

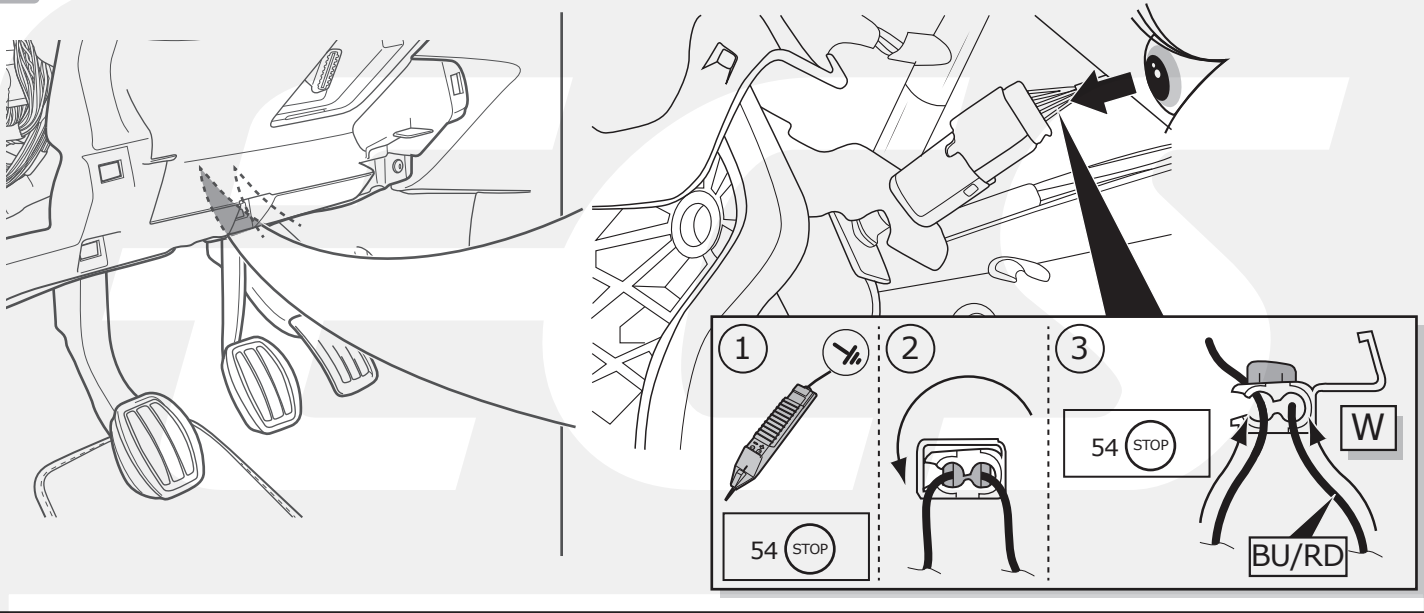

21

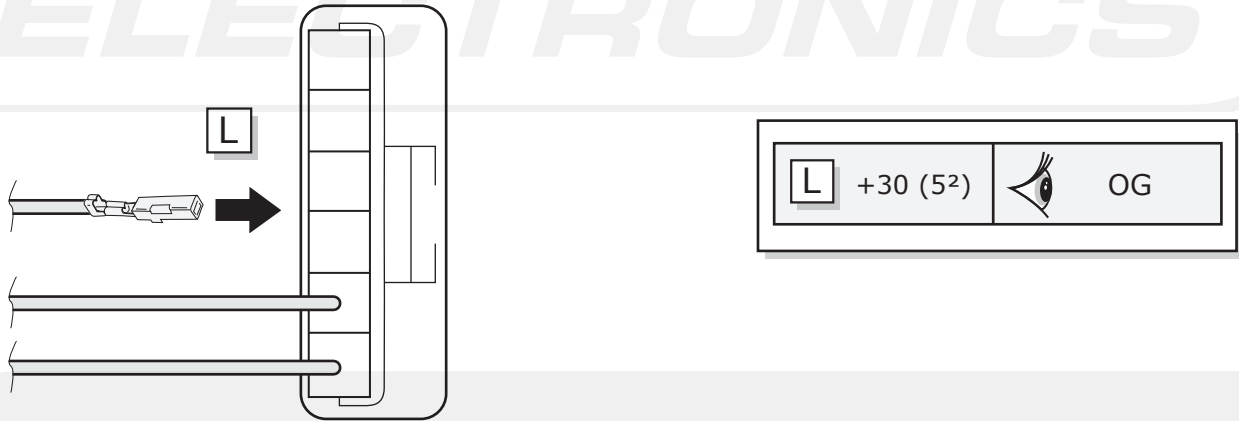

22

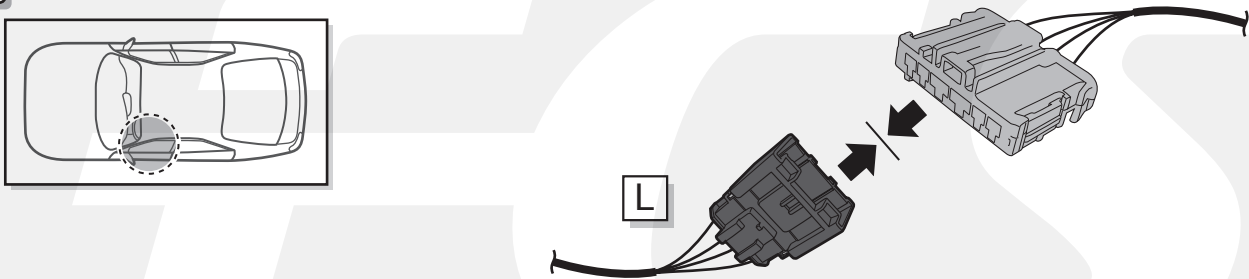

23

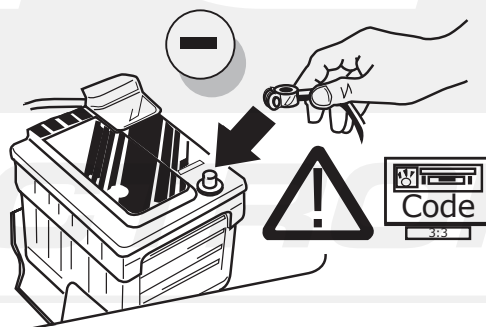



24



25

- |                                                                                                                                                                                                                                                                                                                                                                                                                                                                                                                                                                                                                                                                                                                                       |                                                                                                                                                                                                                                                                                                                                                                                                                                                                                                                                                                                                                                                                                                                                                                                           |
|---------------------------------------------------------------------------------------------------------------------------------------------------------------------------------------------------------------------------------------------------------------------------------------------------------------------------------------------------------------------------------------------------------------------------------------------------------------------------------------------------------------------------------------------------------------------------------------------------------------------------------------------------------------------------------------------------------------------------------------|-------------------------------------------------------------------------------------------------------------------------------------------------------------------------------------------------------------------------------------------------------------------------------------------------------------------------------------------------------------------------------------------------------------------------------------------------------------------------------------------------------------------------------------------------------------------------------------------------------------------------------------------------------------------------------------------------------------------------------------------------------------------------------------------|
| <p><b>DE</b> FUNKTIONEN KONTROLLIEREN MIT EINEM PRÜFGERÄT MIT WIDERSTAND ODER MIT LEUCHTEN MIT DER GENAUEN WATTZAHL!</p> <p><b>FR</b> CONTRÔLER LES FONCTIONS AVEC UNE BOÎTE DE TEST AVEC DE LA CHARGE OU DES LAMPES AVEC LA QUANTITÉ CORRECTE DE WATT!</p> <p><b>NL</b> CONTROLEER FUNCTIES MET EEN TESTER MET BELASTING OF LAMPEN MET DE JUISTE WATTAGE!</p> <p><b>GB</b> TEST ALL CIRCUIT FUNCTIONS WITH A TESTBOX WITH THE CORRECT POWER LOAD FOR EACH UNIT. A TESTBOX ON WHICH ONLY LEDs ARE USED CAN NOT BE USED IN THIS CASE</p> <p><b>ES</b> ¡CONTROLAR FUNCIONES CON UN TESTER CON CARGA O LUCES CON EL CORRECTO WATTAJE!</p> <p><b>IT</b> CONTROLLA FUNZIONI CON UN TESTER CON CARICO O LAMPADE DEL GIUSTO WATT-TAGGIO!</p> | <p><b>SE</b> KONTROLLERA FUNKTIONERNA MED EN TESTARE MED BELASTNING ELLER LAMPOR MED RÄTT WATT-VÄRDE!</p> <p><b>CZ</b> OVĚŘTE FUNKCE POMOCÍ TESTOVACÍHO BOXU NEBO SVĚTEL S PRÍSLUŠNÝM VÝKONEM!</p> <p><b>DK</b> CHECK FUNKTIONERNE MED EN TESTBOKS, MED BELASTNING ELLER MED LYGTER MED DET KORREKTE ANTAL WATT!</p> <p><b>FI</b> TARKISTA TOIMINNOT KÄYTTÄMÄLLÄ TESTILAITE, JOSSA ON OIKEATEHOINEN KUORMITUS TAI OIKEATEHOISET LAMPUT!</p> <p><b>GR</b> ΕΛΕΓΞΤΕ ΤΙΣ ΛΕΙΤΟΥΡΓΙΕΣ ΜΕ ΈΝΑ ΚΙΒΩΤΙΟ ΔΟΚΙΜΗΣ ΜΕ ΦΟΡΤΙΟ Ή ΛΑΜΠΗΡΕΣ ΣΩΣΤΗΣ ΠΟΣΟΤΗΤΑΣ ΒΑΤ!</p> <p><b>NO</b> KONTROLER FUNKSJONENE MED EN TESTER MED BELASTNING ELLER LYSPÆRER MED RIKTIG WATTVERDI!</p> <p><b>PL</b> SPRAWDŹ FUNKCJE UŻYWAJĄC SKRZYŃKI TESTOWEJ Z OBCIĄŻENIEM LUB PODŁĄCZONYMI ŻARÓWKAMI O ODPOWIEDNIEJ MOCY!</p> |
|---------------------------------------------------------------------------------------------------------------------------------------------------------------------------------------------------------------------------------------------------------------------------------------------------------------------------------------------------------------------------------------------------------------------------------------------------------------------------------------------------------------------------------------------------------------------------------------------------------------------------------------------------------------------------------------------------------------------------------------|-------------------------------------------------------------------------------------------------------------------------------------------------------------------------------------------------------------------------------------------------------------------------------------------------------------------------------------------------------------------------------------------------------------------------------------------------------------------------------------------------------------------------------------------------------------------------------------------------------------------------------------------------------------------------------------------------------------------------------------------------------------------------------------------|

26

- DE** Einzelteile wieder einbauen
- FR** Montez les part enlevés
- NL** Terug plaatsen onderdelen
- GB** Reinstall linings
- ES** Reinstalar componentes
- IT** Rimetti a posto componenti
- SE** Sätt tillbaka delar
- CZ** Znovu zasuňte obložení
- DK** Påsæt beklædningen
- FI** Asenna verhoilut takaisin
- GR** Τοποθετήστε ξανά τις επενδύσεις
- NO** Sett tilbake deler
- PL** Założyć wykładzinę

27

- DE** Gebrauchsanleitung.
- FR** Mode d'emploi.
- NL** Gebruikershandleiding.
- GB** User guide.
- ES** Guía del usuario.
- IT** Manuale di istruzioni.
- SE** Bruksanvisning.
- CZ** Uživatelská příručka.
- DK** Brugervejledning.
- FI** Käyttöohjeet.
- GR** Οδηγός χρήστη.
- NO** Brukerveiledning.
- PL** Instrukcja obsługi.

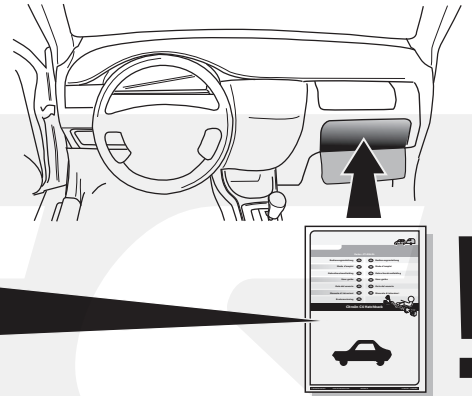

INFO



**00800  
CALL2ECS  
22 55 23 27**

09.00 - 18.00  
Monday - Friday

[www.ecs-electronics.nl](http://www.ecs-electronics.nl)

## Products & Service

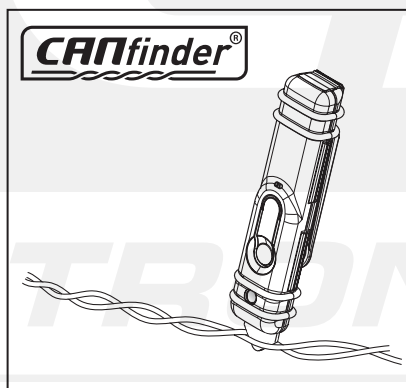

**LIGHT MATE**

















[http://www.ecs-electronics.nl/NL/catalogus/test\\_gereedschap](http://www.ecs-electronics.nl/NL/catalogus/test_gereedschap)

- (DE) Anschluss Steckdose
- (FR) Connection de la prise
- (NL) Contactdoos aansluiting
- (GB) Socket connection

- (ES) Conexión de la caja de enchufe
- (IT) Allaccio zoccolo
- (SE) Anslutning kontaktdosa

- (CZ) Objímkový konektor
- (DK) Stikdåse forbindelse
- (FI) Pistorasia liitäntä
- (GR) Υποδοχή σύνδεσης
- (NO) Tilkobling koblingsboks
- (PL) Połączenie przez gniazdo

| DIN/ISO<br>11446 |  |  |  |  |  |  |  |  |  |  |  |  |
|------------------|-------------------------------------------------------------------------------------|-------------------------------------------------------------------------------------|-------------------------------------------------------------------------------------|-------------------------------------------------------------------------------------|-------------------------------------------------------------------------------------|-------------------------------------------------------------------------------------|-------------------------------------------------------------------------------------|------------------------------------------------------------------------------------|-----------------------------------------------------------------------------------|-----------------------------------------------------------------------------------|-----------------------------------------------------------------------------------|-----------------------------------------------------------------------------------|
| Pmax             | 1/L                                                                                 | 2                                                                                   |  | 4/R                                                                                 | 5/58-R                                                                              | 6/54                                                                                | 7/58-L                                                                              | 8                                                                                  | 180W/15Amp.                                                                       | 10                                                                                |  |  |
|                  | 21W                                                                                 | 21W                                                                                 | 3/31                                                                                | 21W                                                                                 | 52W                                                                                 | 3x21W                                                                               | 52W                                                                                 | 21W                                                                                | 180W/15Amp.                                                                       | 10                                                                                | 11                                                                                | 13                                                                                |
| (DE)             | Gelb                                                                                | Blau                                                                                | Weiß                                                                                | Grün                                                                                | Braun                                                                               | Rot<br>(1,00mm <sup>2</sup> )                                                       | Schwarz                                                                             | Schwarz/<br>Rot                                                                    | Braun/<br>Weiß                                                                    | Rot<br>(2,50mm <sup>2</sup> )                                                     | Weiß                                                                              | Weiß                                                                              |
| (FR)             | Jaune                                                                               | Bleu                                                                                | Blanc                                                                               | Vert                                                                                | Marron                                                                              | Rouge<br>(1,00mm <sup>2</sup> )                                                     | Noir                                                                                | Noir/<br>Rouge                                                                     | Marron/<br>Blanc                                                                  | Rouge<br>(2,50mm <sup>2</sup> )                                                   | Blanc                                                                             | Blanc                                                                             |
| (NL)             | Geel                                                                                | Blaauw                                                                              | Wit                                                                                 | Groen                                                                               | Bruin                                                                               | Rood<br>(1,00mm <sup>2</sup> )                                                      | Zwart                                                                               | Zwart/<br>Rood                                                                     | Bruin/<br>Wit                                                                     | Rood<br>(2,50mm <sup>2</sup> )                                                    | Wit                                                                               | Wit                                                                               |
| (GB)             | Yellow                                                                              | Blue                                                                                | White                                                                               | Green                                                                               | Brown                                                                               | Red<br>(1,00mm <sup>2</sup> )                                                       | Black                                                                               | Black/<br>Red                                                                      | Brown/<br>White                                                                   | Red<br>(2,50mm <sup>2</sup> )                                                     | White                                                                             | White                                                                             |
| (ES)             | Amarillo                                                                            | Azul                                                                                | Blanco                                                                              | Verde                                                                               | Marrón                                                                              | Rojo<br>(1,00mm <sup>2</sup> )                                                      | Negro                                                                               | Negro/<br>Rojo                                                                     | Marrón/<br>Blanco                                                                 | Rojo<br>(2,50mm <sup>2</sup> )                                                    | Blanco                                                                            | Blanco                                                                            |
| (IT)             | Giallo                                                                              | Blu                                                                                 | Bianco                                                                              | Verde                                                                               | Marrone                                                                             | Rosso<br>(1,00mm <sup>2</sup> )                                                     | Nero                                                                                | Nero/<br>Rosso                                                                     | Marrone/<br>Bianco                                                                | Rosso<br>(2,50mm <sup>2</sup> )                                                   | Bianco                                                                            | Bianco                                                                            |
| (SE)             | Gul                                                                                 | Bliå                                                                                | Vit                                                                                 | Grön                                                                                | Brun                                                                                | Röd<br>(1,00mm <sup>2</sup> )                                                       | Svart                                                                               | Svart/<br>Röd                                                                      | Brun/<br>Vit                                                                      | Röd<br>(2,50mm <sup>2</sup> )                                                     | Vit                                                                               | Vit                                                                               |
| (CZ)             | Žlutá                                                                               | Modrá                                                                               | Bílá                                                                                | Zelená                                                                              | Hnědá                                                                               | Červená<br>(1,00mm <sup>2</sup> )                                                   | Černá                                                                               | Černo/<br>Červená                                                                  | Hnědo/<br>Bílá                                                                    | Červená<br>(2,50mm <sup>2</sup> )                                                 | Bílá                                                                              | Bílá                                                                              |
| (DK)             | Gul                                                                                 | Bliå                                                                                | Hvid                                                                                | Grøn                                                                                | Brun                                                                                | Rød<br>(1,00mm <sup>2</sup> )                                                       | Sort                                                                                | Sort/<br>Rød                                                                       | Brun/<br>Hvid                                                                     | Rød<br>(2,50mm <sup>2</sup> )                                                     | Hvid                                                                              | Hvid                                                                              |
| (FI)             | Keltainen                                                                           | Sininen                                                                             | Valkoinen                                                                           | Vihreä                                                                              | Ruskea                                                                              | Punainen<br>(1,00mm <sup>2</sup> )                                                  | Musta                                                                               | Musta/<br>Punainen                                                                 | Ruskea/<br>Valkoinen                                                              | Punainen<br>(2,50mm <sup>2</sup> )                                                | Valkoinen                                                                         | Valkoinen                                                                         |
| (GR)             | Κίτρινο                                                                             | Μπλε                                                                                | Λευκό                                                                               | Πράσινο                                                                             | Καφέ                                                                                | Κόκκινο<br>(1,00mm <sup>2</sup> )                                                   | Μαύο                                                                                | Μαύο/<br>Κόκκινο                                                                   | Καφέ/<br>Λευκό                                                                    | Κόκκινο<br>(2,50mm <sup>2</sup> )                                                 | Λευκό                                                                             | Λευκό                                                                             |
| (NO)             | Gul                                                                                 | Bliå                                                                                | Hvit                                                                                | Grønn                                                                               | Brun                                                                                | Rød<br>(1,00mm <sup>2</sup> )                                                       | Svart                                                                               | Svart/<br>Rød                                                                      | Brun/<br>Hvit                                                                     | Rød<br>(2,50mm <sup>2</sup> )                                                     | Hvit                                                                              | Hvit                                                                              |
| (PL)             | Żółty                                                                               | Niebieski                                                                           | Biały                                                                               | Zielony                                                                             | Brazowy                                                                             | Czerwony<br>(1,00mm <sup>2</sup> )                                                  | Czarny                                                                              | Czarny/<br>Czerwony                                                                | Brazowy/<br>Biały                                                                 | Czerwony<br>(2,50mm <sup>2</sup> )                                                | Biały                                                                             | Biały                                                                             |