

Einbauanleitung Elektrosatz  
Anhängervorrichtung mit 13-P Steckdose  
lt. DIN/ISO Norm 11446

Instructions de montage du faisceau  
électrique pour crochet d'attelage  
conforme à la norme  
DIN/ISO 11446 prise 13-P

Fitting instructions electric wiringkit  
towbar with 13-P socket up to  
DIN/ISO norm 11446

Montage-handleiding elektrokabelset voor  
trekhaak met 13-P contactdoos  
vlgs. DIN/ISO norm 11446

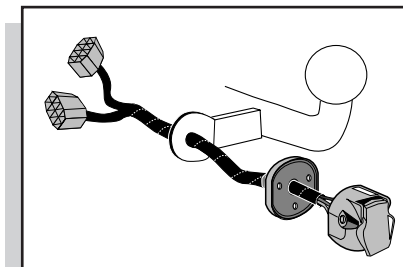

## KIA CARNIVAL 1999-

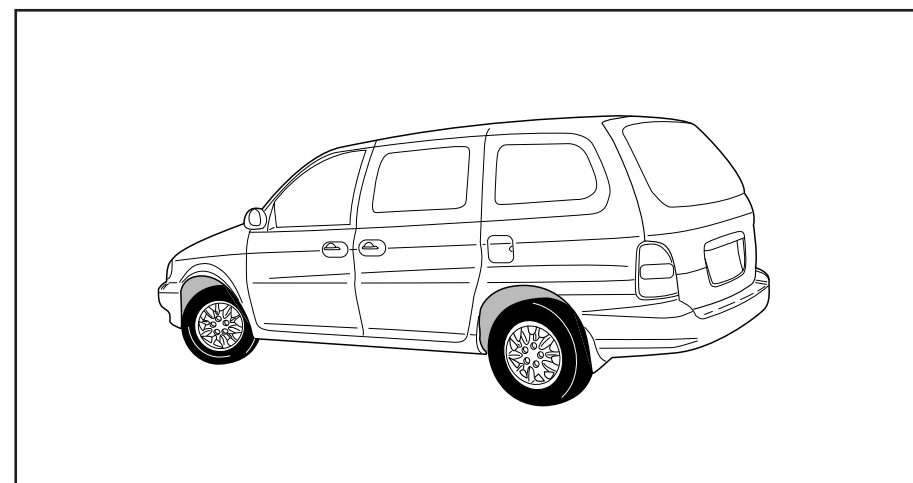

Bestel Nr.: KI-003-HB

\* Teilliste

\* Liste de pieces

\* Part list

\* Onderdelenlijst

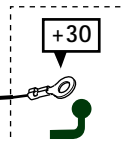
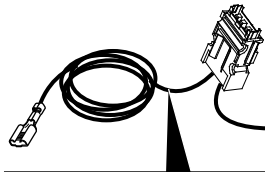
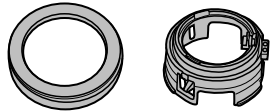
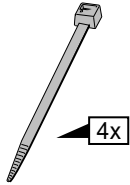
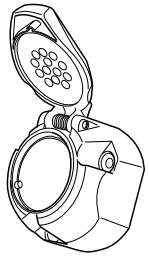
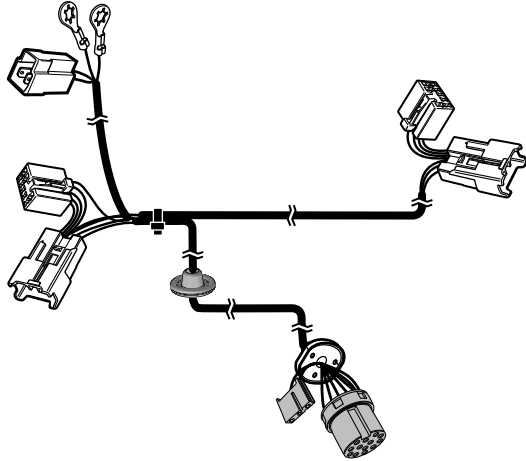
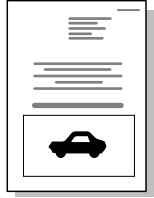
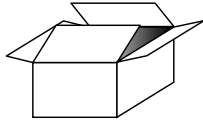

Braun/Weiß Maron/Blanc  
Brown/White Bruin/Wit

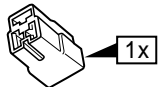
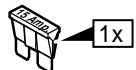
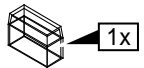
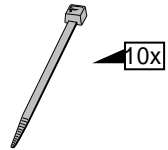
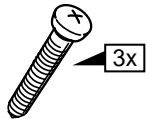

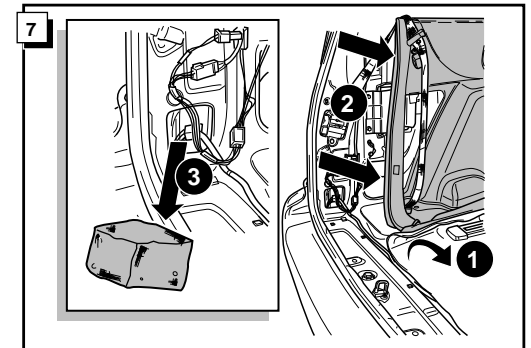
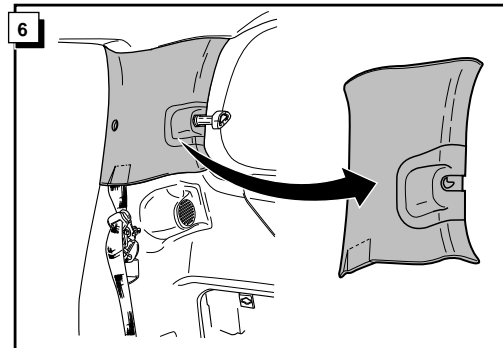
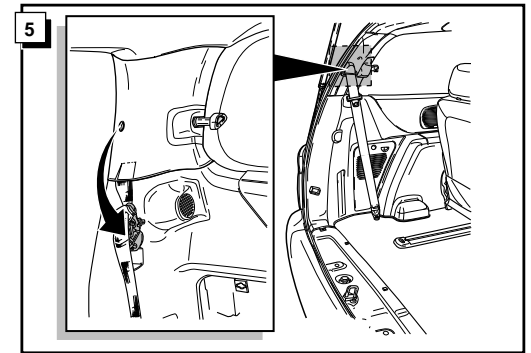
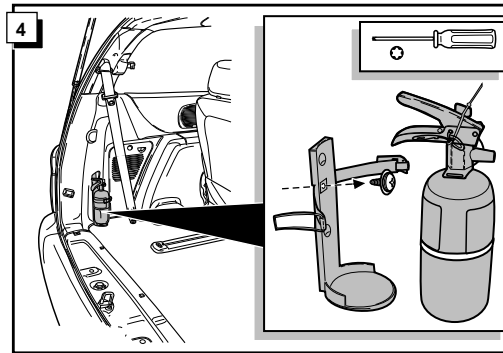
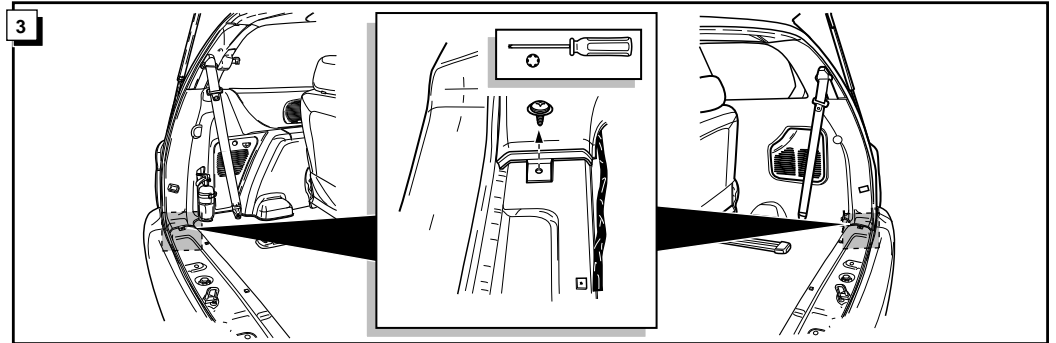
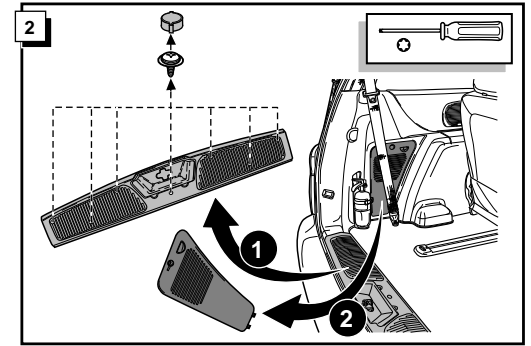
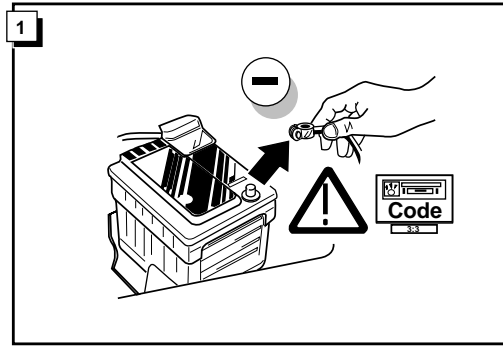

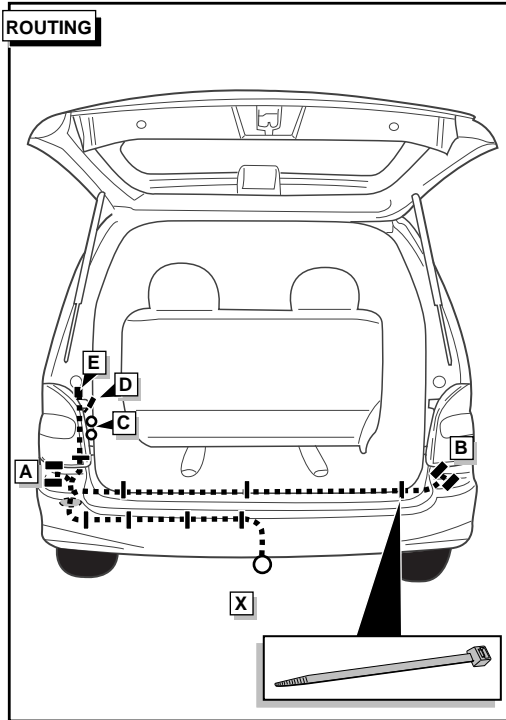
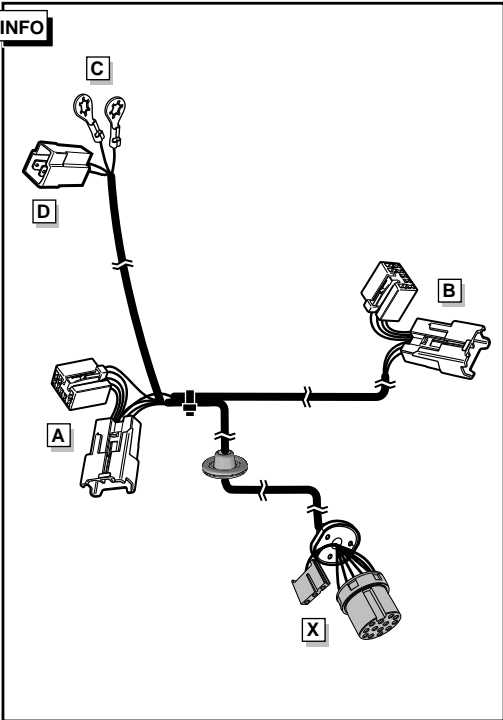
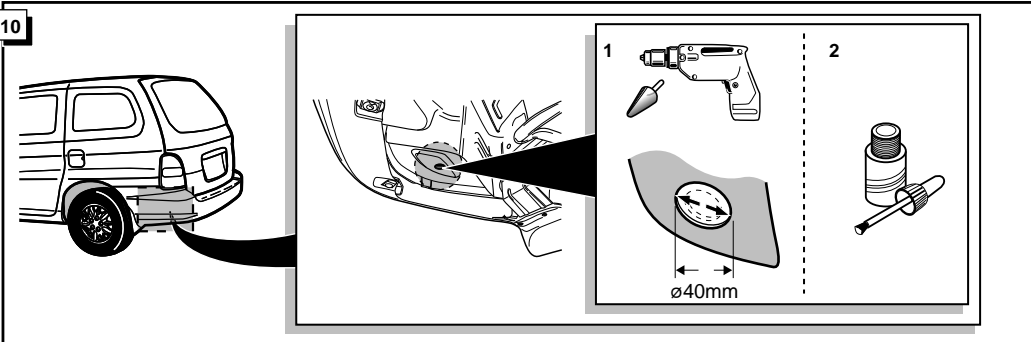
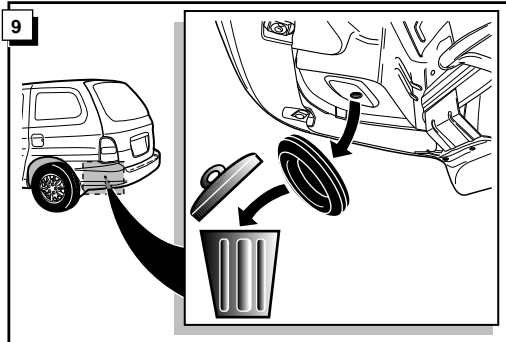
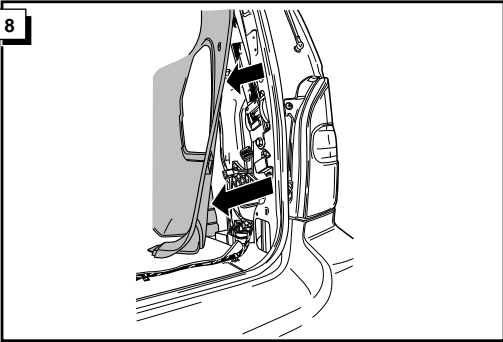

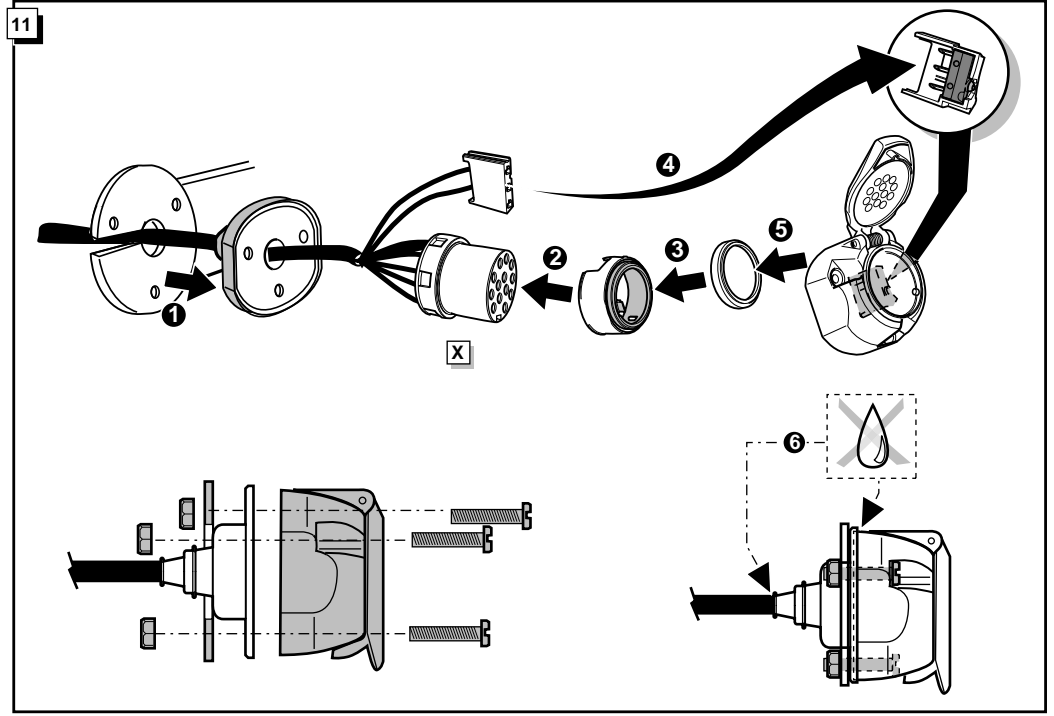
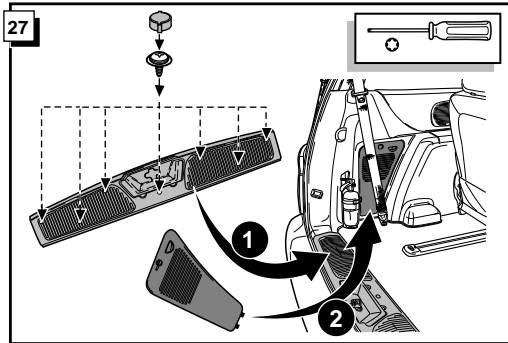
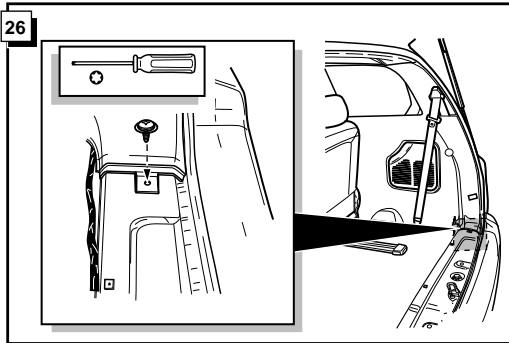
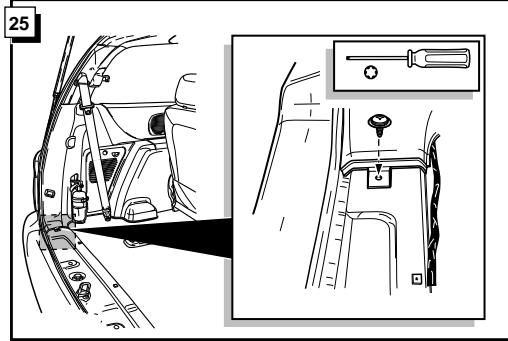
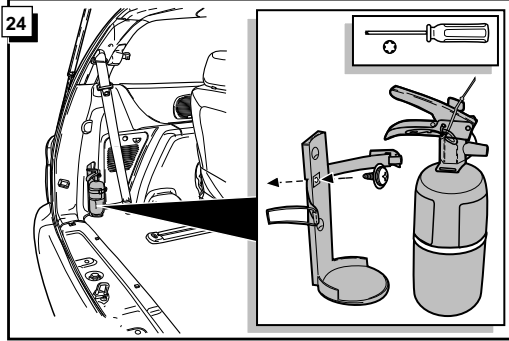
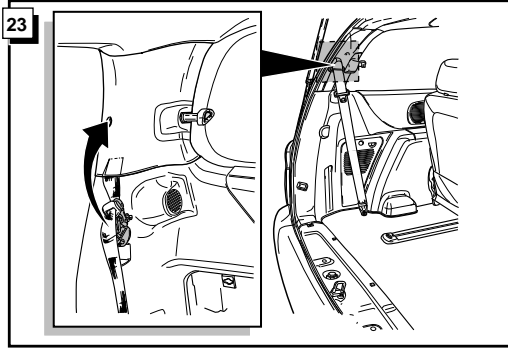
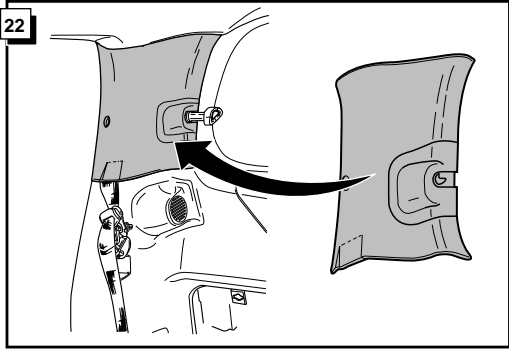

**INFO** Anschluß Steckdose / Connection de la prise / Socket connection / Contactdoos aansluiting

DIN/ISO 11446	(D)	(F)	(GB)	(NL)
1/L	gelb	jaune	yellow	geel
2	blau	bleu	blue	blauw
2a	grau	gris	grey	grijs
1-8	weiß	blanc	white	wit
4/R	grün	vert	green	groen
5/58-R	braun	marron	brown	bruin
6/54	rot	rouge	red	rood
7/58-L	schwarz	noir	black	zwart
Reverse	schwarz/rot	noir/rouge	black/red	zwart/rood
9	braun/weiß	marron/blanc	brown/white	bruin/wit
10	rot	rouge	red	rood
11	weiß	blanc	white	wit
12	rot/blau	rouge/bleu	red/blue	rood/blauw
13	weiß	blanc	white	wit

