

## Kia Soul 2008- & 2012-

Partnr.: KI-067-DH

**DE** Einbauanleitung Elektrosatz Anhängervorrichtung mit 13-P Steckdose lt. DIN/ISO Norm 11446

**FR** Instructions de montage du faisceau électrique pour crochet d'attelage conforme à la norme DIN/ISO 11446 prise 13-V.

**NL** Montage-handleiding elektrokabelset voor trekhaak met 13-P contactdoos vlg. DIN/ISO norm 11446.

**GB** Fitting instructions electric wiring kit tow bar with 13-P socket up to DIN/ISO Norm 11446.

**ES** Instrucciones de montaje de kit eléctrico para engancho de remolque con caja de conexiones 13-P según norma DIN/ISO 11446.

**IT** Istruzioni di montaggio di set di cavi elettrici per gancio da traino con zoccolo a 13-P conforme alla norma DIN/ISO 11446.

**SE** Monteringsanvisningar elkabelsats för dragkrok med 13-P kontaktdosa enligt DIN/ISO norm 11446.

**CZ** Montážní pokyny: souprava pro elektrické propojení tažné tyče s 13-P zásuvkou do normy DIN/ISO 11446.

**DK** Monteringsvejledninger for det elektriske ledningsføringssæt for trækstang med 13-N stikdåse, DIN/ISO, norm 11446.

**FI** Ohjeet vetokoukun sähkökaapelisarjan asentamiseen, jossa on DIN/ISO 11446 mukainen 13-N liitin.

**GR** Οδηγίες συναρμολόγησης ηλεκτρικού σετ καλωδίων μπάρας ρυμούλκησης με υποδοχή 13-P μέχρι DIN/ISO Κανόνας 11446.

**NO** Monteringsanviser elkabelsett for trekrok med 13-P koblingsboks ifølge DIN/ISO norm 11446.

**PL** Instrukcje montażu zestawu okablowania elektrycznego dyszla holowniczego z 13-stykowym gniazdem DIN/ISO 11446.

**DE** - Wir weisen ausdrücklich darauf hin, dass eine unsachgemäße und nicht in einer Fachwerkstatt durchgeführte Montage einen Verzicht auf Entschädigung jeglicher Art insbesondere bezüglich des Produkthaftpflichtrechts zur Folge hat

**FR** - Il est expressément prévu qu' on ne saurait se prévaloir d'un quelconque préjudice contractuel ou rédhitoire si le montage avait été fait en dépit des dites instructions ou dans un garage ne disposant pas des équipements adéquats.

**NL** - Wij wijzen er met nadruk op, dat ondeskundige en niet door een vakkundige werkplaats uitgevoerde montage tot gevolg heeft dat daardoor ieder recht op schadevergoeding, ook op wettelijke aansprakelijkheid inzake producten, vervalt.

**GB** - We would expressly point out that assembly not carried out properly by a competent installer will result in cancellation of any right to damage compensation, in particular those arising by virtue of the product liability act.

**ES** - El montaje inapropiado y efectuado por personal no cualificado originará la pérdida de todo derecho a indemnización o la expiración de toda responsabilidad civil con respecto al producto.

**IT** - Sottolineiamo espressamente che un montaggio inadeguato ed eseguito da un'officina non specializzata ha come conseguenza il decadere di qualsiasi diritto al risarcimento danni, nonché alla responsabilità legale relativa ai prodotti.

**SE** - Vi påpekar med eftertryck att all rätt till skadeersättning och all laglig ansvarighet förfaller om monteringen inte har utförts på rätt sätt och av en professionell verkstad.

**CZ** - Výslovně zdůrazňujeme, že jakákoli montáž, která není provedená ve specializované dílně, má za následek odvolání nároků na kompenzaci jakéhokoliv druhu, obzvláště vyplývajících ze zákona o odpovědnosti za způsobené škody.

**DK** - Vi ønsker at gøre udtrykkeligt opmærksom på at forkert samling, der ikke er udført af et specialiseret værksted, resulterer i bortfaldelse af kompenseringskrav af alle slags, i særdeles krav der måtte opstå omkring det lovpligtige ansvar.

**FI** - Korostamme, että kaikki oikeudet vahinkokorvaukseen kuten myös valmistajan laillinen vastuu raukeavat, mikäli asennusta ei ole toteutettu oikealla tavalla eikä ammattitaitoisen asiantuntijan toimesta.

**GR** - Επισημαίνουμε κατηγορηματικά ότι οποιαδήποτε εσφαλμένη συναρμολόγηση, η οποία δεν έχει πραγματοποιηθεί ειδικό εργαστήριο θα οδηγήσει σε απονομή των αξιώσεων επιβολής αποζημιώσεων οποιαδήποτε είδους, ειδικά όσα προκύπτουν από το νόμο ευθύνης προϊόντων.

**NO** - Vi påpeker ettertrykkelig at all rett til skadeerstatning og rettslig ansvar forfaller dersom monteringen ikke er blitt utført på riktig måte og av et profesjonelt verksted.

**PL** - Chcielibyśmy wyraźnie zaznaczyć, iż wszelki nieprawidłowy montaż, który nie jest wykonywany w specjalistycznym warsztacie pociąga za sobą utratę możliwości dochodzenia wszelkiego typu roszczeń, w szczególności tych wynikających z odpowiedzialności producenta za swój produkt.

- Technische Änderungen vorbehalten.  
- Widerstand nur gemäß der Tabelle auf dem Anhänger verwenden.

- Sous réserve de modifications techniques.  
- Ne excédez pas la charge maximale, indiquée dans le tableau.

- Technische wijzigingen voorbehouden.  
- Gebruik alleen belasting volgens aansluittabel op het getrokken voertuig.

- Contents of these kits and their fitting manuals are subject to alteration without notice, please ensure that these instructions are read and fully understood before commencing installation.  
- Do not overload circuits; the maximum loads per connection are detailed in this manual.

- Nos reservamos el derecho a efectuar modificaciones técnicas.  
- Utilice sólo cargas de acuerdo a la tabla de conexión del vehículo remolcado.

- Ci si riserva il diritto di apportare modifiche tecniche.  
- Utilizzare esclusivamente un carico conforme alla tabella degli allacci relativa al veicolo in questione.

- Tekniska ändringar förbehålles.  
- Använd endast belastning enligt anslutningstabellen på det dragna fordonet.

- Změny mohou být provedeny bez oznámení.  
- Používejte pouze při maximálním nabití podle tabulky na tažném vozidle.

- Kan ændres uden varsel.  
- Brug kun den maksimale belastning, i overensstemmelse med forbindelsestabelen for bugserede køretøjer.

- Oikeus teknisiin muutoksiin ilman erillistä huomautusta pidätetään.  
- Kuormita työvirtapiiriä ainoastaan hinattavan ajoneuvon kytkentäkaavion mukaisesti.

- Μπορεί να τροποποιηθεί χωρίς προηγούμενη ειδοποίηση.  
- Χρησιμοποιείτε μόνο μέγιστο ηλεκτρικό φορτίο σύμφωνα με τον πίνακα σύνδεσης στο ρυμούλκούμενο όχημα.

- Tekniske endringer forbeholdes. - Overskrid ikke grensene anviset i tilkoblingstabellen på tilhengeren eller det tilkoblede kjøretøyet.

- Podlega zmianom bez powiadomienia.  
- Używać tylko takiego maksymalnego obciążenia które wynika z tabliczki połączeń holowanego pojazdu.

Einzelteilliste

Liste de pieces

Onderdelenlijst

Part list

Lista de componentes

Elenco componenti

Dellista

Seznam dílů

Del-liste

Osaluettelo

Κατάλογος εξαρτημάτων

Delliste

Lista części

DE

FR

NL

GB

ES

IT

SE

CZ

DK

FI

GR

NO

PL

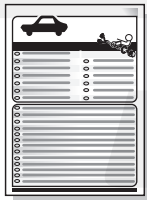
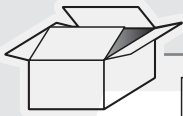

R2

R1

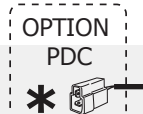

G

X

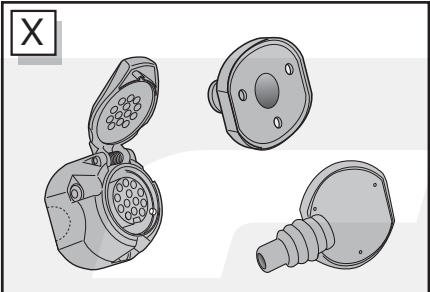
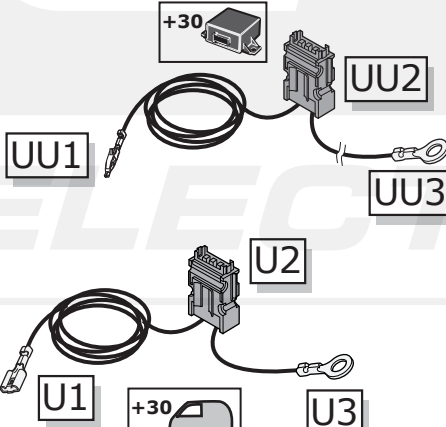

**\* OPTION P.D.C.**

PARK DISTANCE CONTROL

↓

PARK DISTANCE CONTROL

👁️ ➔ **Pag. 12**

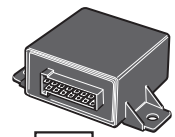

M1

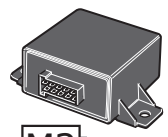

M2



2x



6x



2x

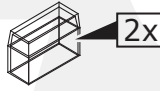

2x

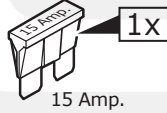

1x

15 Amp.

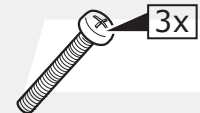

3x



3x

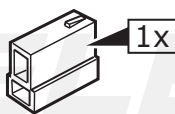

1x

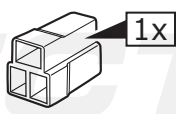

1x

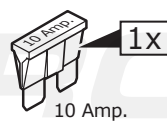

1x

10 Amp.



2x

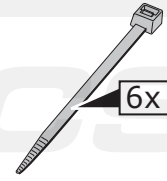

6x

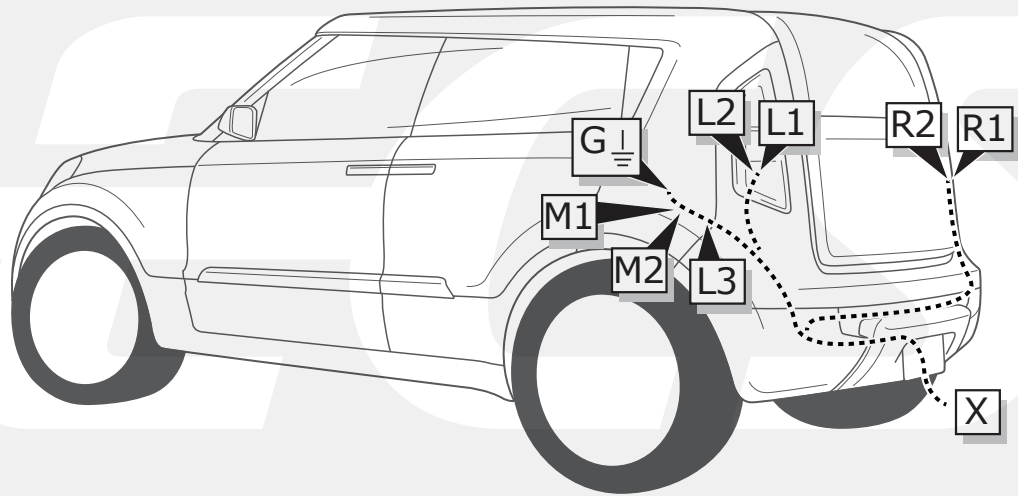

ELECTRONICS

1

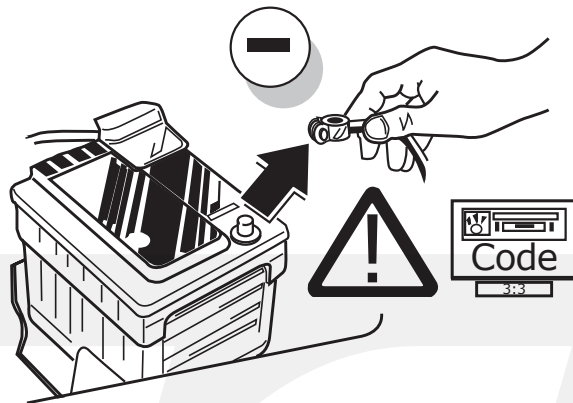

2

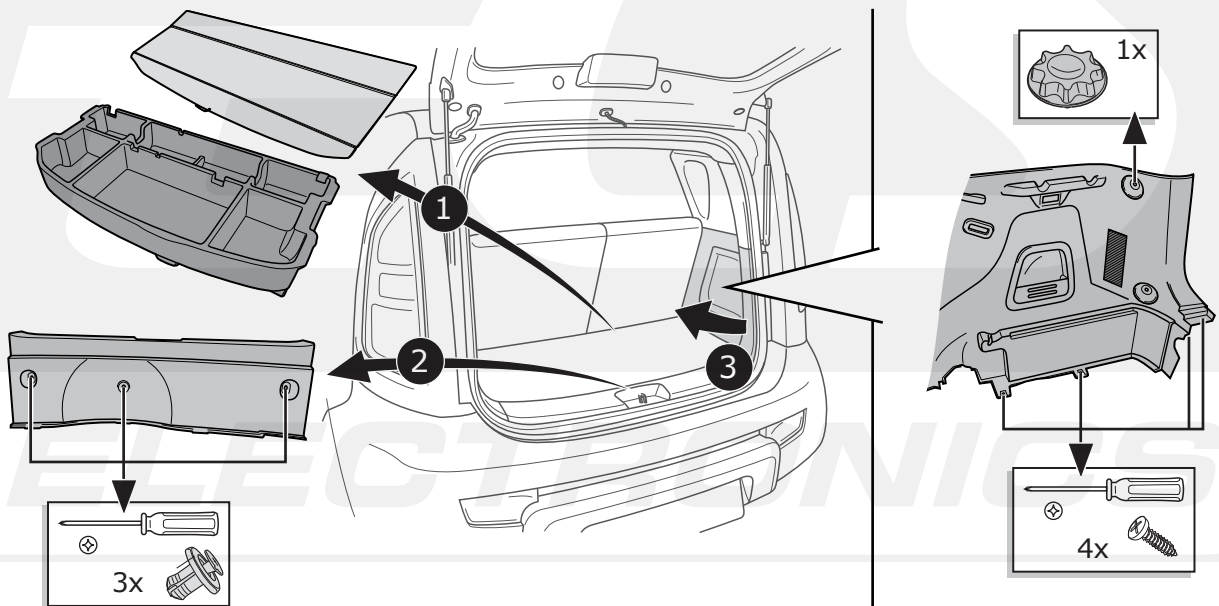

3

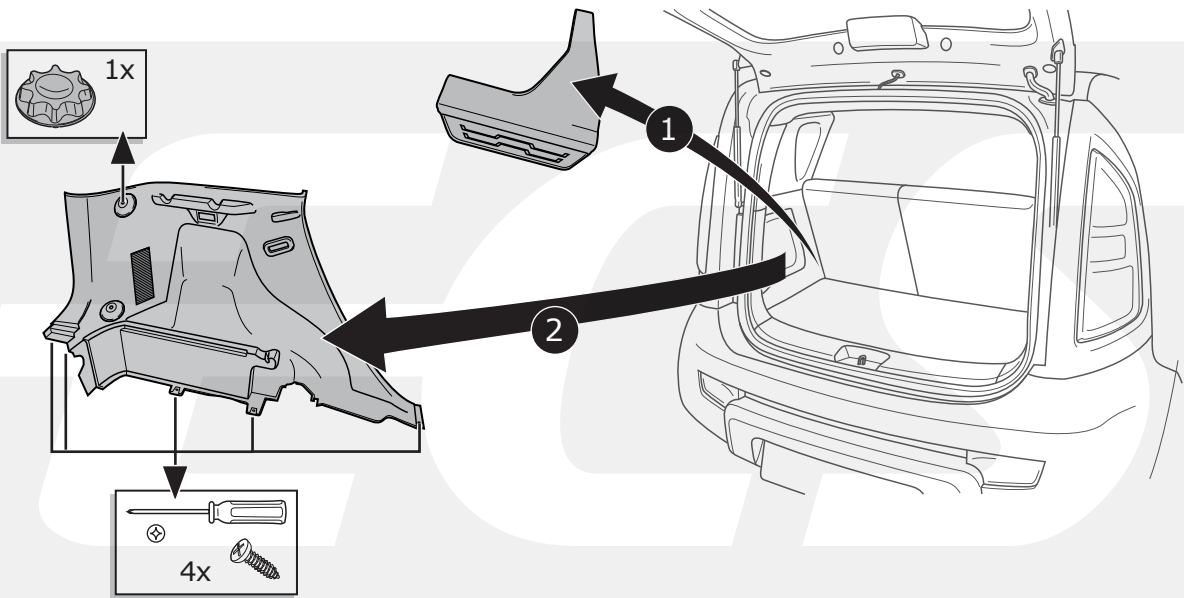

4

1

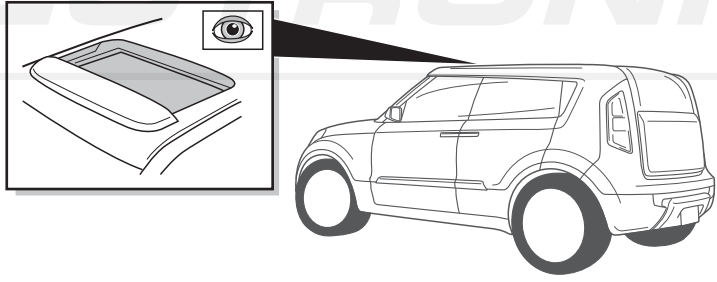

2

OPTION 1

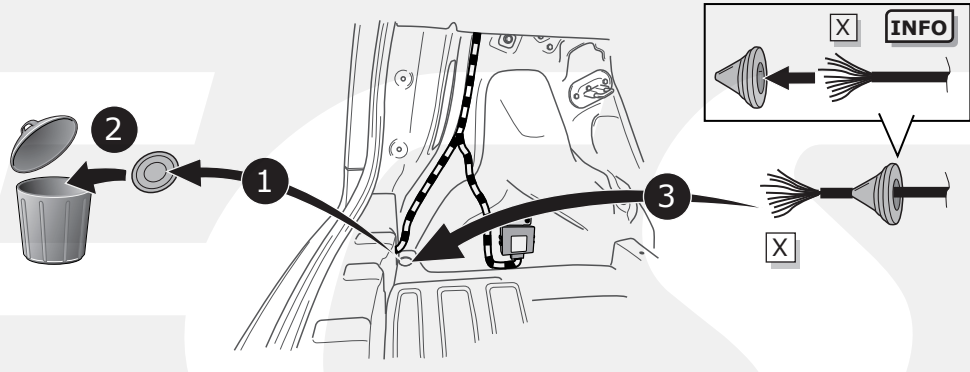
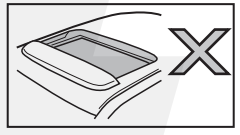

OPTION 2

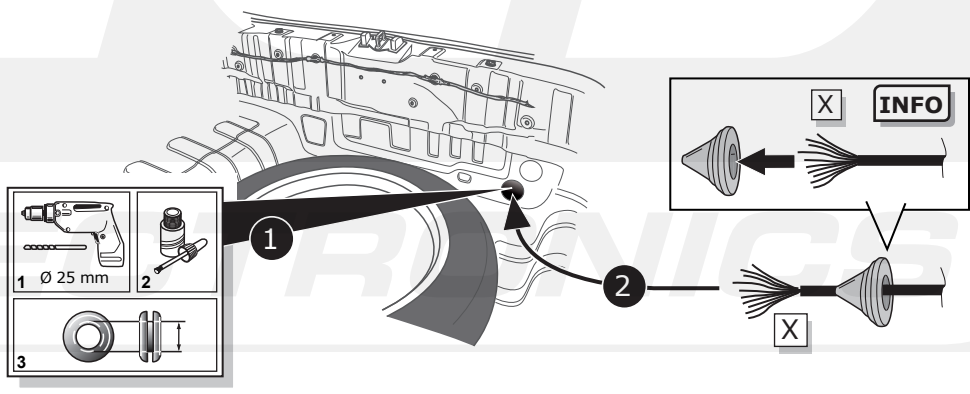
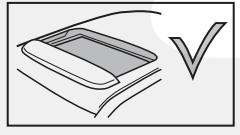

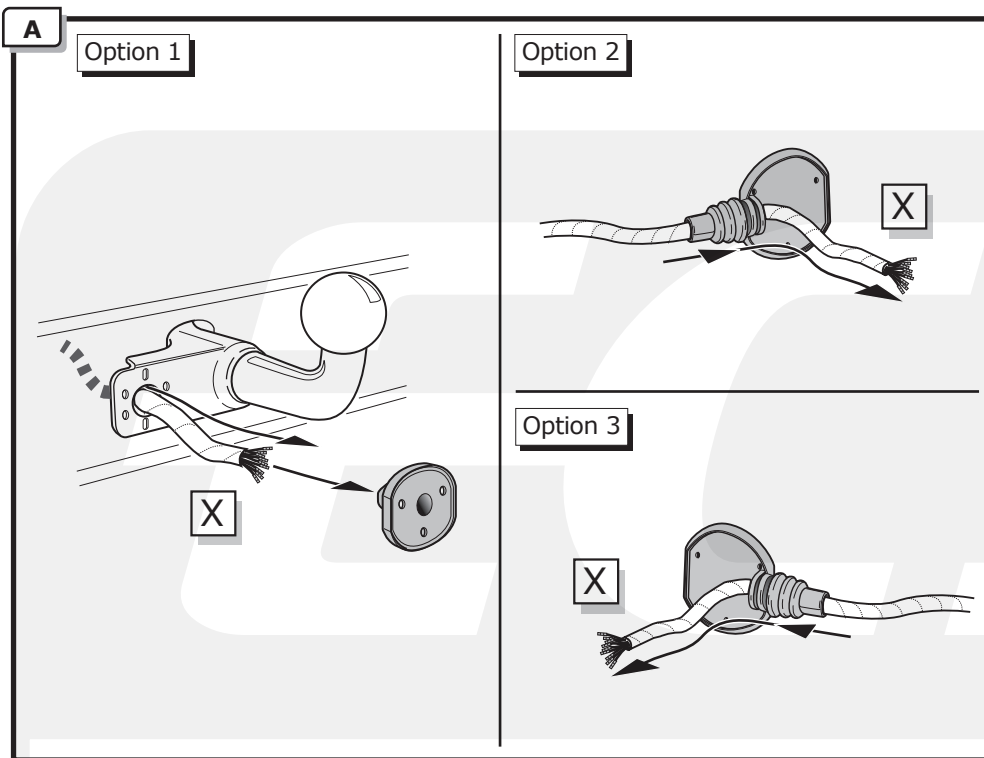

**INFO**

- (DE) Anschluss Steckdose
- (FR) Connection de la prise
- (NL) Contactdoos aansluiting
- (GB) Socket connection
- (ES) Conexión de la caja de enchufe
- (IT) Allaccio zoccolo
- (SE) Anslutning kontaktdosa
- (CZ) Objímkový konektor
- (DK) Stikdåse forbindelse
- (FI) Pistorasia liitäntä
- (GR) Υποδοχή σύνδεσης
- (NO) Tilkobling koblingsboks
- (PL) Połączenie przez gniazdo

**Pag. 13**

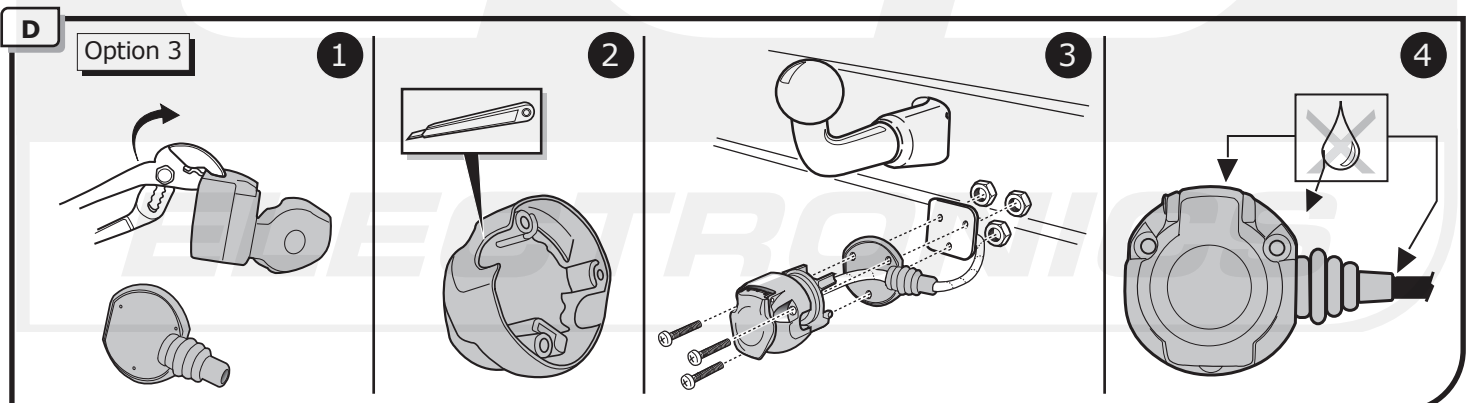
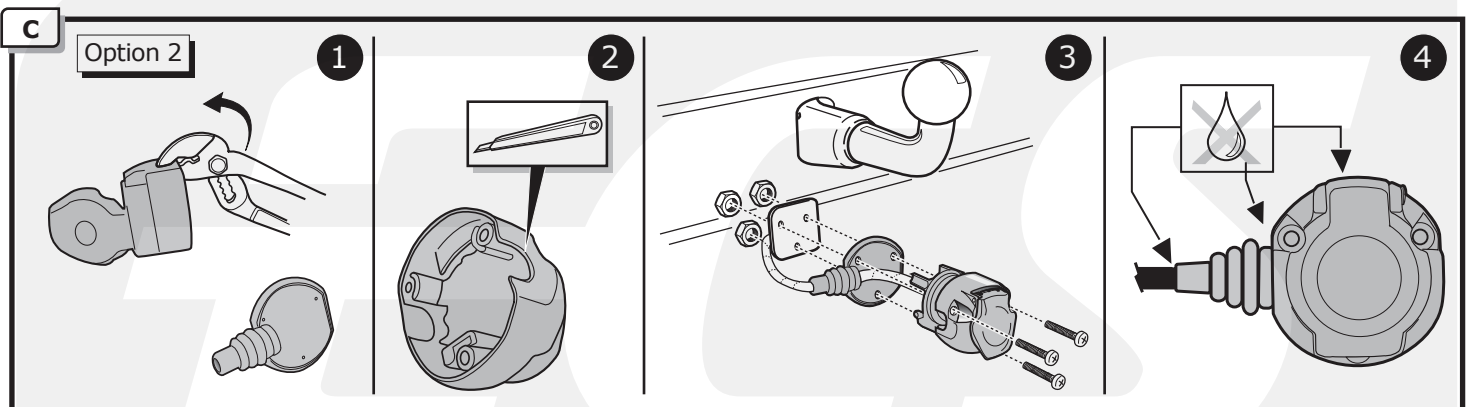
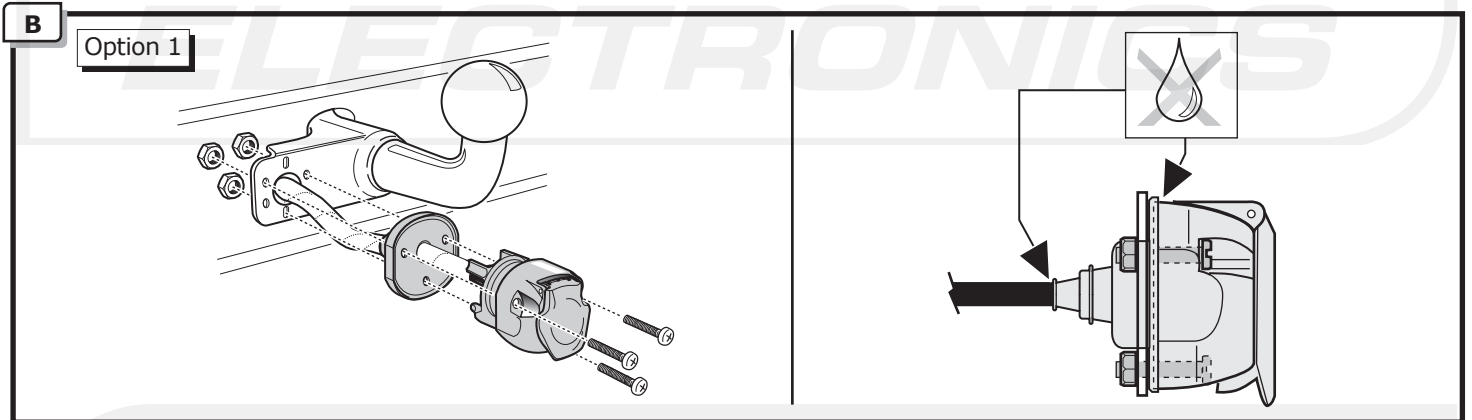

5

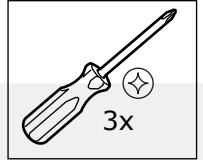
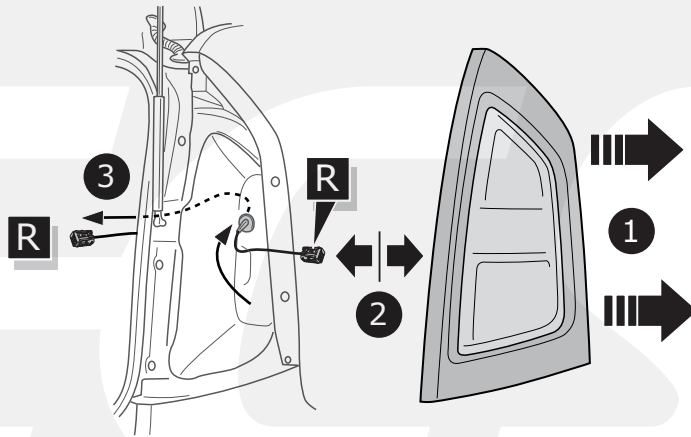
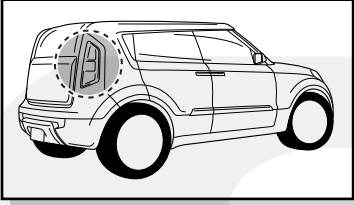

6

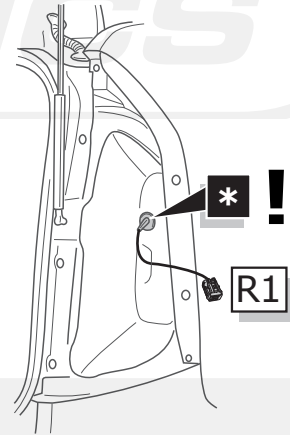
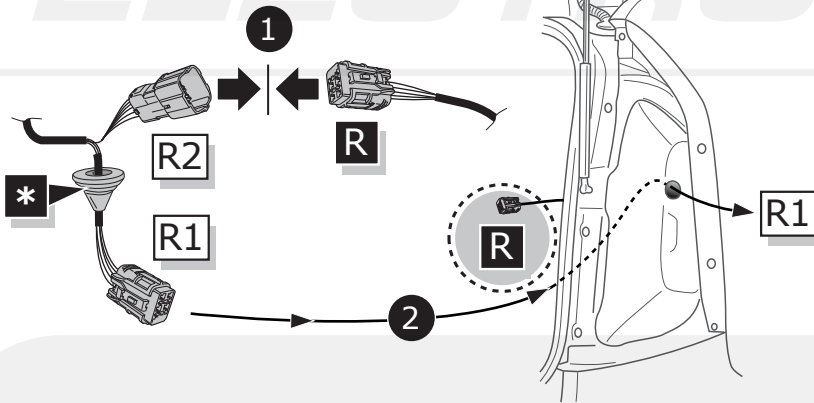

7

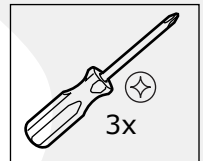
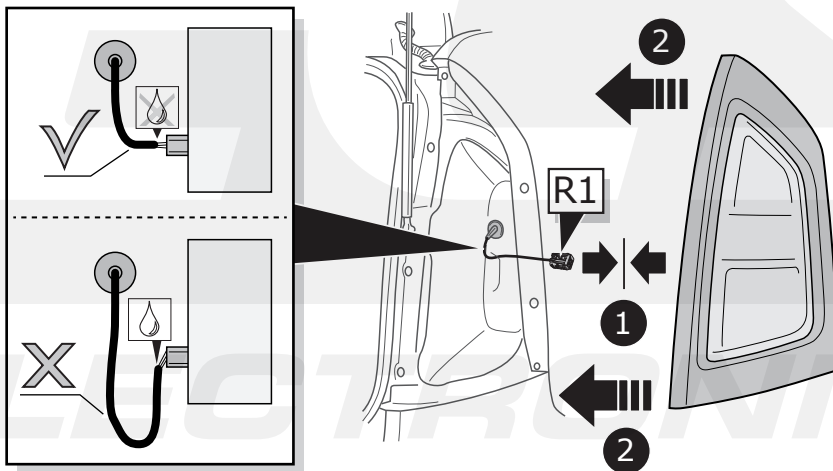

8

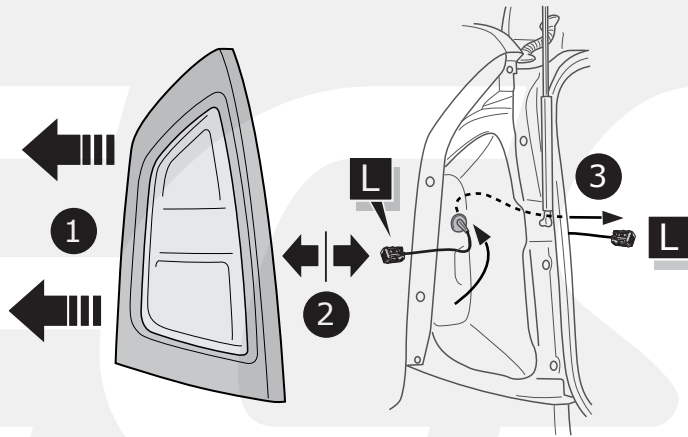
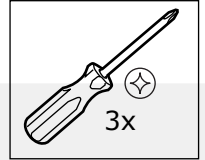
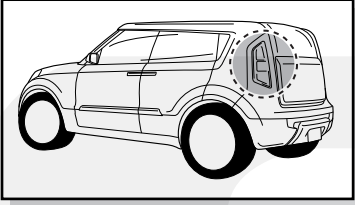

9

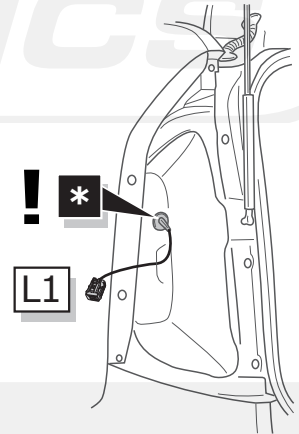
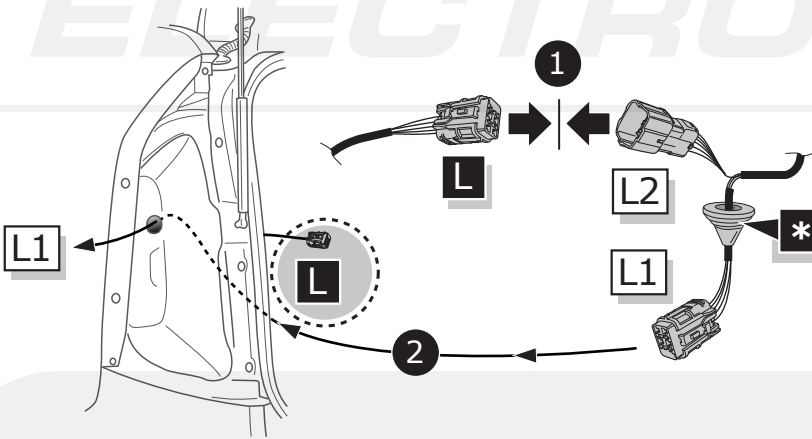

10

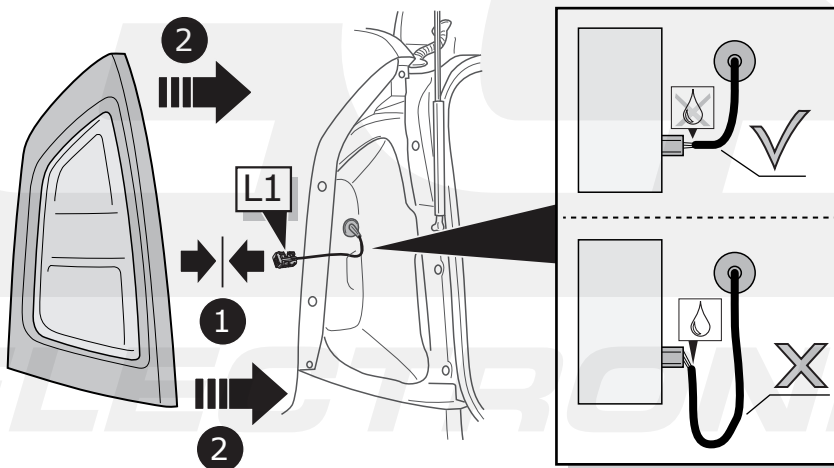
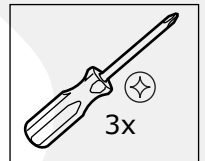

11

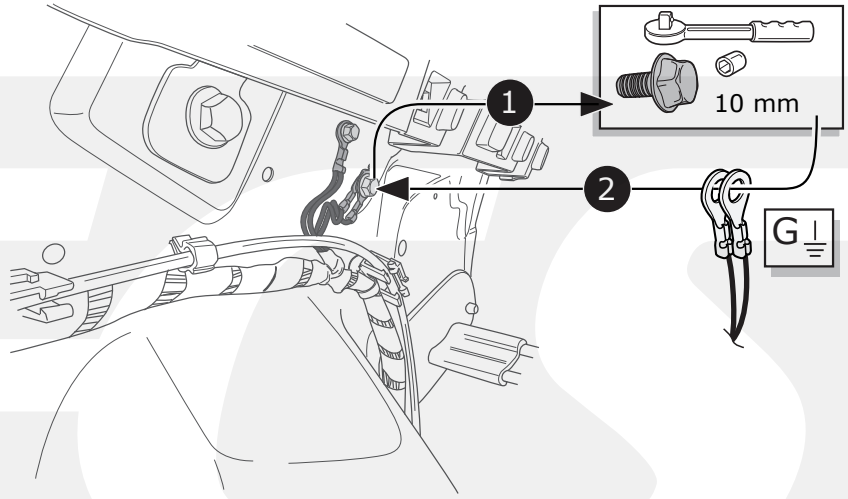
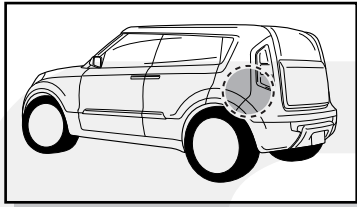

12

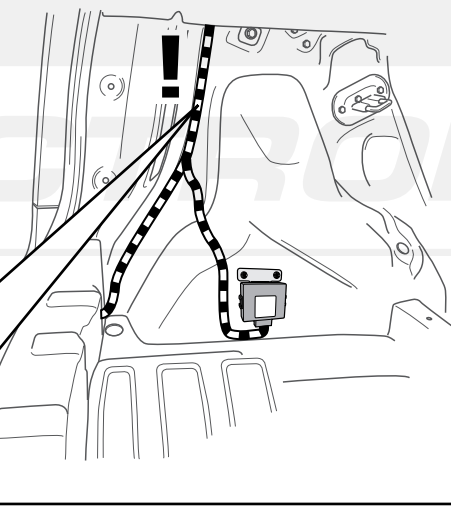
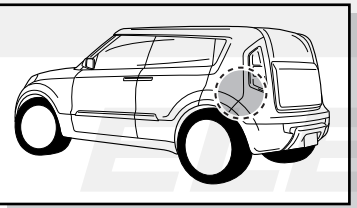

L3

2x

1

54G

DE	Grau	CZ	Šedá
FR	Gris	DK	Grå
NL	Grijs	FI	Harmaa
GB	Grey	GR	Γκρι
ES	Gris	NO	Grå
IT	Grigio	PL	Szary
SE	Grå	RU	Серый

2

1

2

2x

2x

L3

DE	Rot/Gelb	CZ	Červeno/Žlutá
FR	Rouge/Jaune	DK	Rød/Gul
NL	Rood/Geel	FI	Punainen/Keltainen
GB	Red/Yellow	GR	Κόκκινο/Κίτρινο
ES	Rojo/Amarillo	NO	Rød/Gul
IT	Rosso/Giallo	PL	Czerwony/Żółty
SE	Röd/Gul	RU	Красный/Желтый

DE	Grau	CZ	Šedá
FR	Gris	DK	Grå
NL	Grijs	FI	Harmaa
GB	Grey	GR	Γκρι
ES	Gris	NO	Grå
IT	Grigio	PL	Szary
SE	Grå	RU	Серый



13

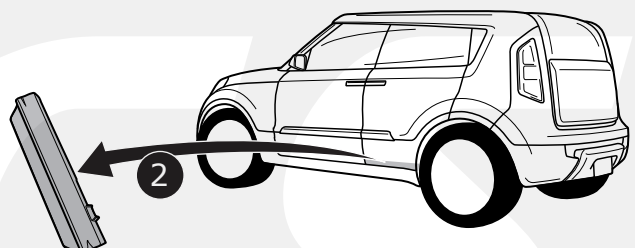
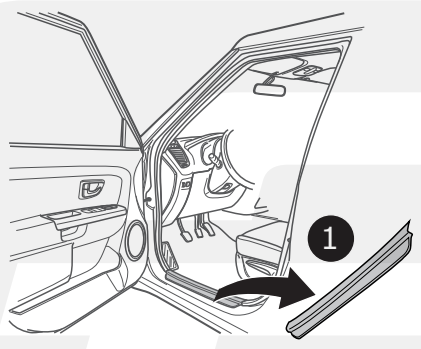

14

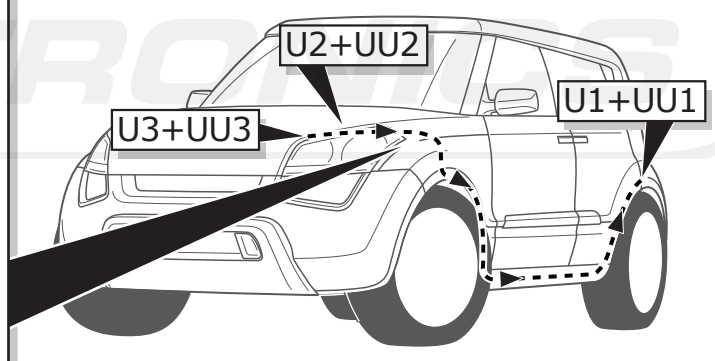
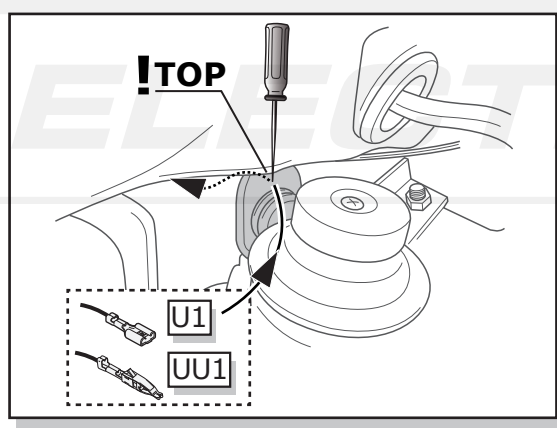

15

DE	Braun/Weiß	DK	Brun/Hvid
FR	Marron/Blanc	FI	Ruskea/Valkoinen
NL	Bruin/Wit	GR	Καφέ/Λευκό
GB	Brown/White	NO	Brun/Hvit
ES	Marrón/Blanco	PL	Brązowy/Biały
IT	Marrone/Bianco	RU	Коричневый/Белый
SE	Brun/Vit		
CZ	Hnědo/Bílá		

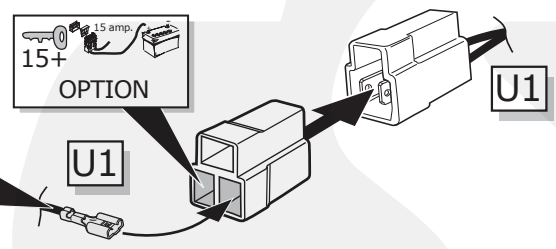

1

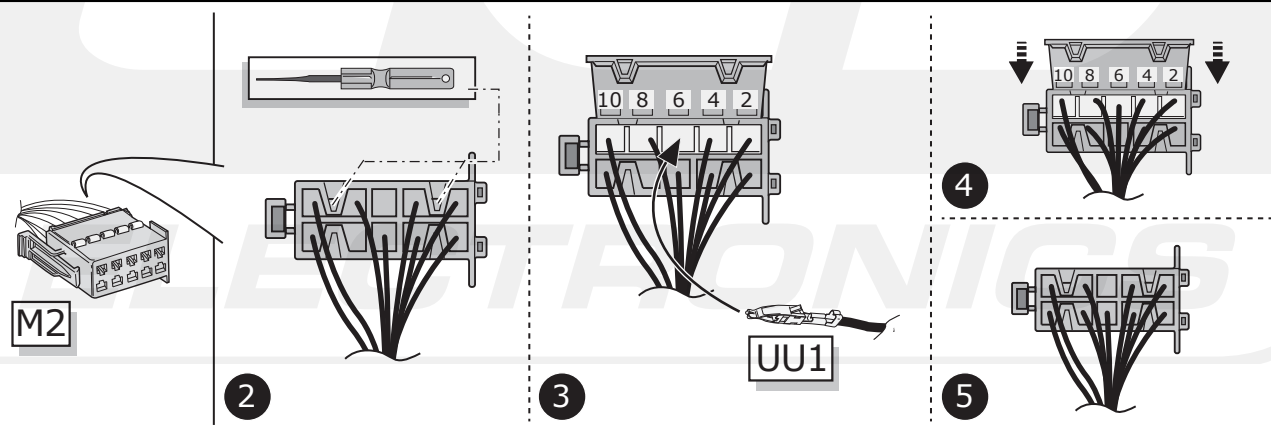

16

1

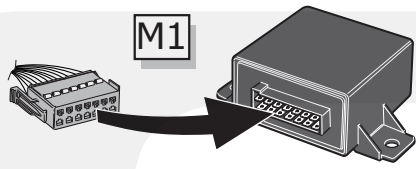

3

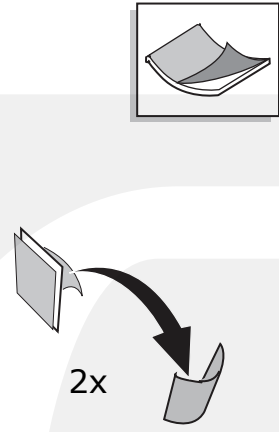

4

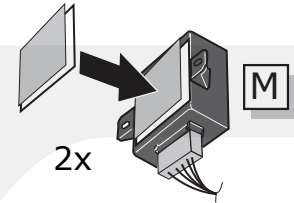

2

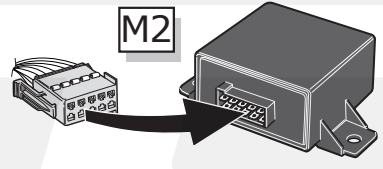

5

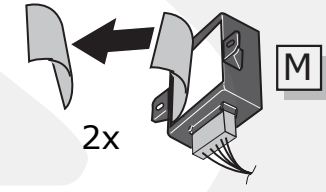

17

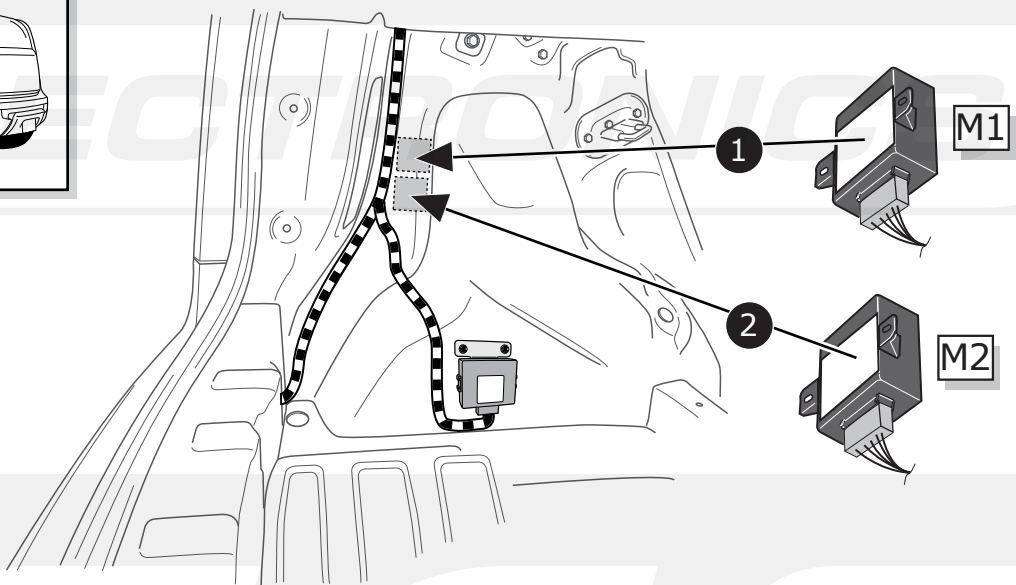
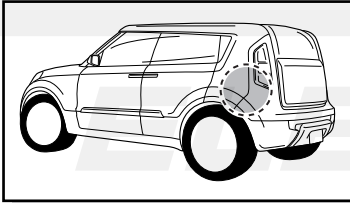

18

1

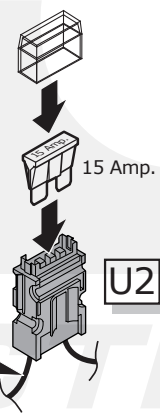

DE	Braun/Weiß	DK	Brun/Hvid
FR	Marron/Blanc	FI	Ruskea/Valkoinen
NL	Bruin/Wit	GR	Καφέ/Λευκό
GB	Brown/White	NO	Brun/Hvit
ES	Marrón/Blanco	PL	Brązowy/Biały
IT	Marrone/Bianco	RU	Коричневый/Белый
SE	Brun/Vit		
CZ	Hnědo/Bílá		



2

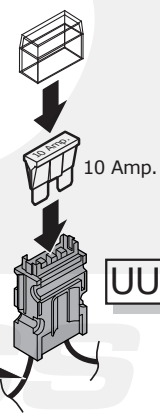

DE	Orange	DK	Orange
FR	Orange	FI	Oranssi
NL	Oranje	GR	Πορτοκάλι
GB	Orange	NO	Oransje
ES	Naranja	PL	Pomarańczowy
IT	Arancione		
SE	Orange		
CZ	Oranžová		



19

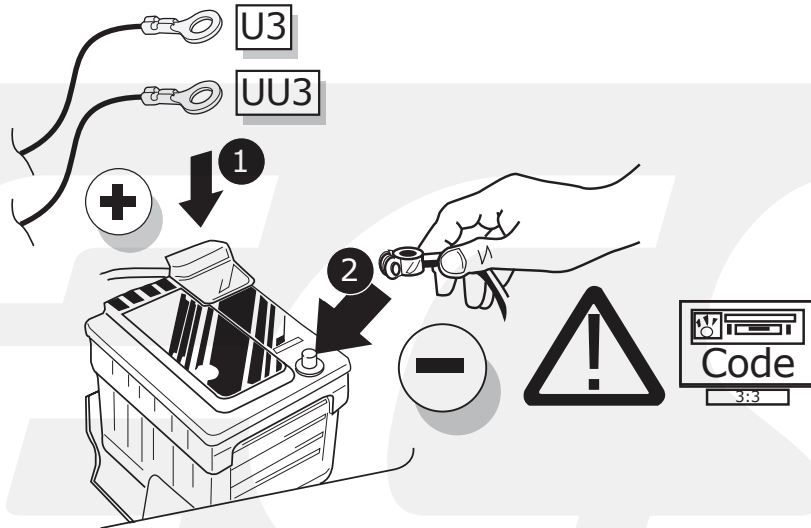

20

(DE) FUNKTIONEN KONTROLLIEREN MIT EINEM PRÜFGERÄT MIT WIDERSTAND ODER MIT LEUCHTEN MIT DER GENAUEN WATTZAHL!

(FR) CONTRÔLER LES FONCTIONS AVEC UNE BOÎTE DE TEST AVEC DE LA CHARGE OU DES LAMPES AVEC LA QUANTITÉ CORRECTE DE WATT!

(NL) CONTROLEER FUNCTIES MET EEN TESTER MET BELASTING OF LAMPEN MET DE JUISTE WATTAGE!

(GB) TEST ALL CIRCUIT FUNCTIONS WITH A TESTBOX WITH THE CORRECT POWER LOAD FOR EACH UNIT. A TESTBOX ON WHICH ONLY LEDs ARE USED CAN NOT BE USED IN THIS CASE

(ES) ¡CONTROLAR FUNCIONES CON UN TESTER CON CARGA O LUCES CON EL CORRECTO WATTAJE!

(IT) CONTROLLA FUNZIONI CON UN TESTER CON CARICO O LAMPADE DEL GIUSTO WATT-TAGGIO!

(SE) KONTROLLERA FUNKTIONERNA MED EN TESTARE MED BELASTNING ELLER LAMPOR MED RÄTT WATT-VÄRDE!

(CZ) OVĚŘTE FUNKCE POMOČÍ TESTOVACÍHO BOXU NEBO SVĚTEL S PŘÍSLUŠNÝM VÝKONEM!

(DK) CHECK FUNKTIONERNE MED EN TESTBOKS, MED BELASTNING ELLER MED LYGTER MED DET KORREKTE ANTAL WATT!

(FI) TARKISTA TOIMINNOT KÄYTTÄMÄLLÄ TESTILAITE, JOSSA ON OIKEATEHOINEN KUORMITUS TAI OIKEATEHOISET LAMPUT!

(GR) ΕΛΕΓΞΤΕ ΤΙΣ ΛΕΙΤΟΥΡΓΙΕΣ ΜΕ ΈΝΑ ΚΙΒΩΤΙΟ ΔΟΚΙΜΗΣ ΜΕ ΦΟΡΤΙΟ Ή ΛΑΜΠΙΡΕΣ ΣΩΣΤΗΣ ΠΟΣΟΤΗΤΑΣ ΒΑΤ!

(NO) KONTROLER FUNKSJONENE MED EN TESTER MED BELASTNING ELLER LYSÆRER MED RIKTIG WATTVERDI!

(PL) SPRAWDŹ FUNKCJE UŻYWAJĄC SKRZYŃKI TESTOWEJ Z OBCIĄŻENIEM LUB PODŁĄCZONYMI ŻARÓWKAMI O ODPOWIEDNIEJ MOCY!

INFO

(DE) Einzelteile wieder einbauen

(FR) Montez les part enlevées

(NL) Terug plaatsen onderdelen

(GB) Reinstall linings

(ES) Reinstalar componentes

(IT) Rimetti a posto componenti

(SE) Sätt tillbaka delar

(CZ) Znovu zasuňte obložení

(DK) Påsæt beklædningen

(FI) Asenna verhoilut takaisin

(GR) Τοποθετήστε ξανά τις επενδύσεις

(NO) Sett tilbake deler

(PL) Założyć wykładzinę

21

- (DE) Gebrauchsanleitung.
- (FR) Mode d'emploi.
- (NL) Gebruikershandleiding.
- (GB) User guide.
- (ES) Guía del usuario.
- (IT) Manuale di istruzioni.
- (SE) Bruksanvisning.
- (CZ) Uživatelská příručka.
- (DK) Brugervejledning.
- (FI) Käyttöohjeet.
- (GR) Οδηγός χρήστη.
- (NO) Brukerveiledning.
- (PL) Instrukcja obsługi.

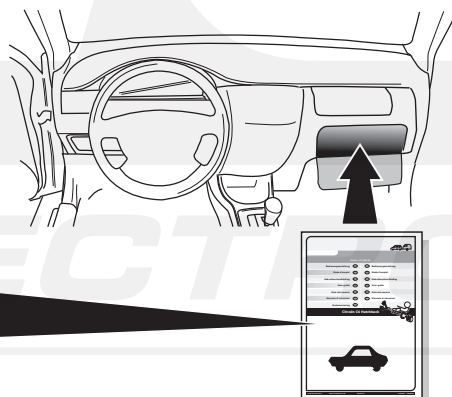

**00800**  
**CALL2ECS**  
**22 55 23 27**

09.00 - 18.00

Monday - Friday

[www.ecs-electronics.nl](http://www.ecs-electronics.nl)

### Option 1

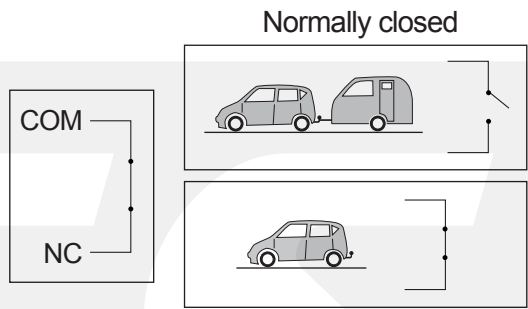
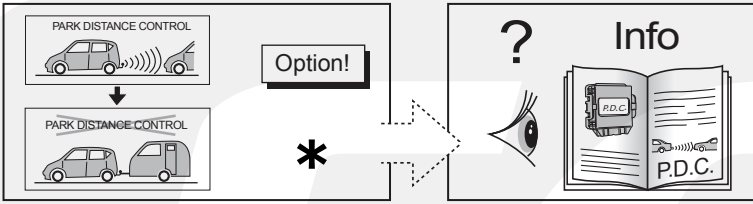

### For OEM installed PDC systems

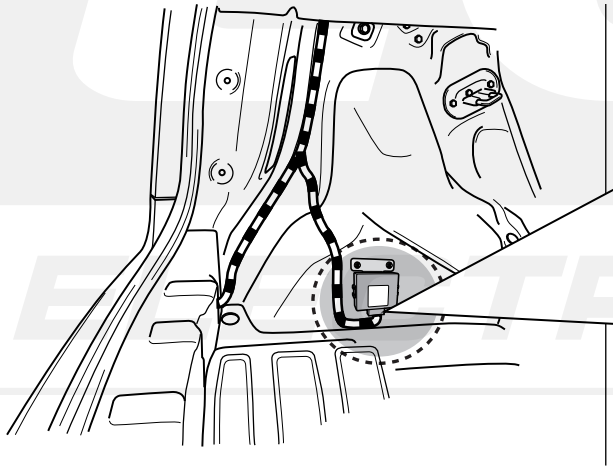

1

DE	Grün	CZ	Zelená
FR	Vert	DK	Grøn
NL	Groen	FI	Vihreä
GB	Green	GR	Πράσινο
ES	Verde	NO	Grønn
IT	Verde	PL	Zielony
SE	Grön	RU	Зеленый

**PIN 10**

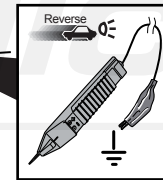

2

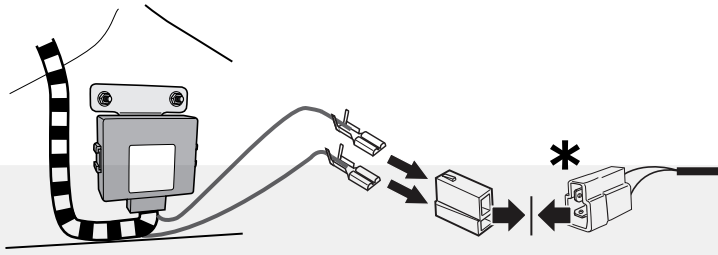

### For aftermarket installed PDC systems

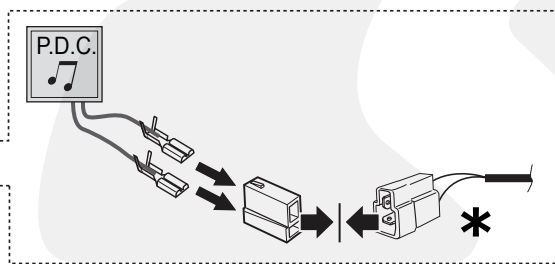
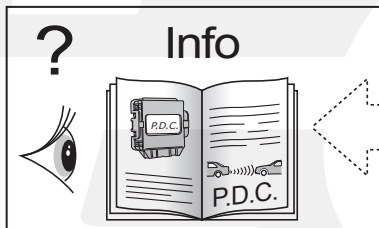

1

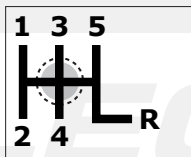
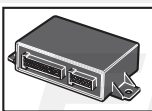

Neutral

2

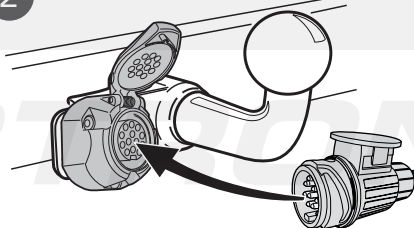

3

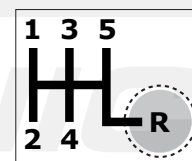







4

**TEST**

(DE) Anschluss Steckdose  
(FR) Connection de la prise  
(NL) Contactdoos aansluiting  
(GB) Socket connection

(ES) Conexión de la caja de enchufe  
(IT) Allaccio zoccolo  
(SE) Anslutning kontaktdosa

(CZ) Objímkový konektor  
(DK) Stikdåse forbindelse  
(FI) Pistorasia liitäntä  
(GR) Υποδοχή σύνδεσης  
(NO) Tilkobling koblingsboks  
(PL) Połączenie przez gniazdo

DIN/ISO 11446	↔		≡ 1-8	↗				Reverse			≡ 10	—	≡ 9
Pmax	1/L	2	3/31	4/R	5/58-R	52W	3x21W	8	180W/15Amp.	10	11	12	13
(DE)	Gelb	Blau	Weiß	Grün	Braun	Schwarz	Rot (1,00mm <sup>2</sup> )	Schwarz/ Rot	Braun/ Weiß	Rot (2,50mm <sup>2</sup> )	Weiß	Rot/ Blau	Weiß
(FR)	Jaune	Bleu	Blanc	Vert	Marron	Noir	Rouge (1,00mm <sup>2</sup> )	Noir/ Rouge	Marron/ Blanc	Rouge (2,50mm <sup>2</sup> )	Blanc	Rouge/ Bleu	Blanc
(NL)	Geel	Blauw	Wit	Groen	Bruin	Zwart	Rood (1,00mm <sup>2</sup> )	Zwart/ Rood	Bruin/ Wit	Rood (2,50mm <sup>2</sup> )	Wit	Rood/ Blauw	Wit
(GB)	Yellow	Blue	White	Green	Brown	Black	Red (1,00mm <sup>2</sup> )	Black/ Red	Brown/ White	Red (2,50mm <sup>2</sup> )	White	Red/ Blue	White
(ES)	Amarillo	Azul	Blanco	Verde	Marrón	Negro	Rojo (1,00mm <sup>2</sup> )	Negro/ Rojo	Marrón/ Blanco	Rojo (2,50mm <sup>2</sup> )	Blanco	Rojo/ Azul	Blanco
(IT)	Giallo	Blu	Bianco	Verde	Marrone	Nero	Rosso (1,00mm <sup>2</sup> )	Nero/ Rosso	Marrone/ Bianco	Rosso (2,50mm <sup>2</sup> )	Bianco	Rosso/ Blu	Bianco
(SE)	Gul	Blå	Vit	Grön	Brun	Svart	Röd (1,00mm <sup>2</sup> )	Svart/ Röd	Brun/ Vit	Röd (2,50mm <sup>2</sup> )	Vit	Röd/ Blå	Vit
(CZ)	Žlutá	Modrá	Bílá	Zelená	Hnědá	Černá	Červená (1,00mm <sup>2</sup> )	Černo/ Červená	Hnědo/ Bílá	Červená (2,50mm <sup>2</sup> )	Bílá	Červeno/ Modrá	Bílá
(DK)	Gul	Blå	Hvid	Grøn	Brun	Sort	Rød (1,00mm <sup>2</sup> )	Sort/ Rød	Brun/ Hvid	Rød (2,50mm <sup>2</sup> )	Hvid	Rød/ Blå	Hvid
(FI)	Keltainen	Sininen	Valkoinen	Vihreä	Ruskea	Musta	Punainen (1,00mm <sup>2</sup> )	Musta/ Punainen	Ruskea/ Valkoinen	Punainen (2,50mm <sup>2</sup> )	Valkoinen	Punainen/ Sininen	Valkoinen
(GR)	Κίτρινο	Μπλε	Λευκό	Πράσινο	Καφέ	Μαύρο	Κόκκινο (1,00mm <sup>2</sup> )	Μαύρο/ Κόκκινο	Καφέ/ Λευκό	Κόκκινο (2,50mm <sup>2</sup> )	Λευκό	Κόκκινο/ Μπλε	Λευκό
(NO)	Gul	Blå	Hvit	Grønn	Brun	Svart	Rød (1,00mm <sup>2</sup> )	Svart/ Rød	Brun/ Hvit	Rød (2,50mm <sup>2</sup> )	Hvit	Rød/ Blå	Hvit
(PL)	Żółty	Niebieski	Biały	Zielony	Brazowy	Czarny	Czerwony (1,00mm <sup>2</sup> )	Czarny/ Czerwony	Brazowy/ Biały	Czerwony (2,50mm <sup>2</sup> )	Biały	Czerwony/ Niebieski	Biały