

Einbauanleitung Elektrosatz
Anhängervorrichtung mit 13-P Steckdose
lt. DIN/ISO Norm 11446

Instructions de montage du faisceau
électrique pour crochet d'attelage
conforme à la norme
DIN/ISO 11446 prise 13-P

Fitting instructions electric wiringkit
towbar with 13-P socket up to
DIN/ISO norm 11446

Montage-handleiding elektrokabelset voor
trekhaak met 13-P contactdoos
vlgs. DIN/ISO norm 11446

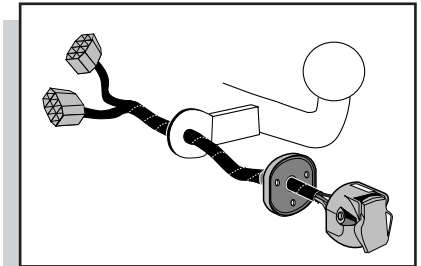

RENAULT LAGUNA BREAK

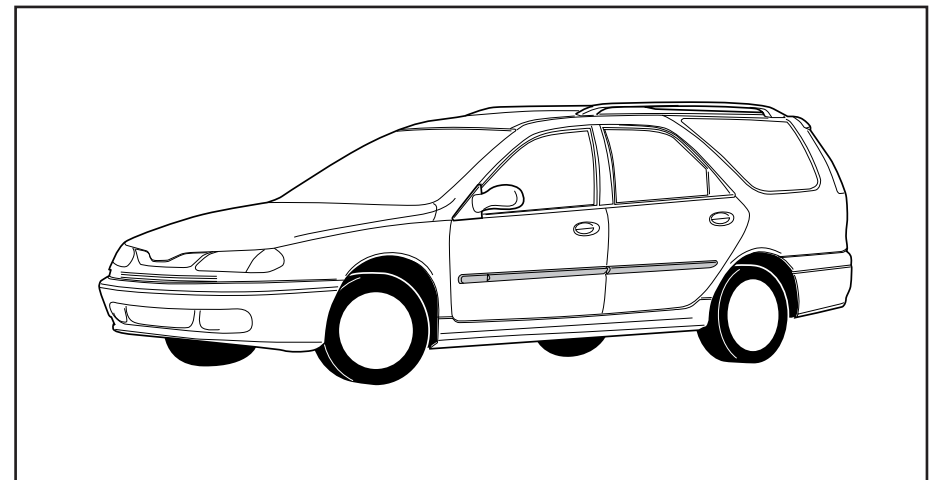

Bestel Nr.: REN-927-B

* Teilliste

* Liste de pieces

* Part list

* Onderdelenlijst

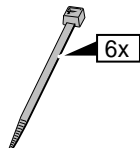
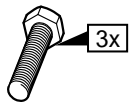
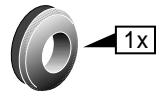
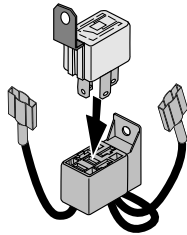
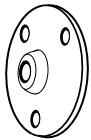
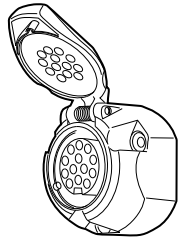
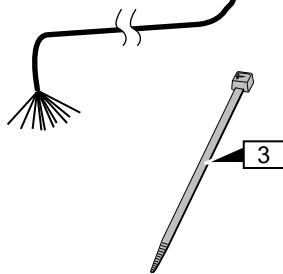
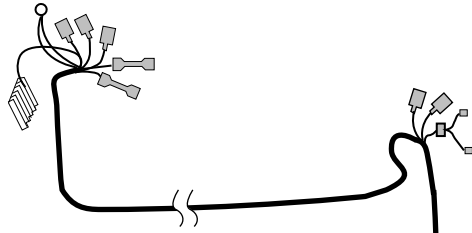
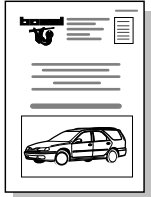
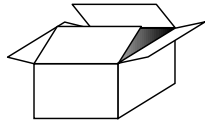

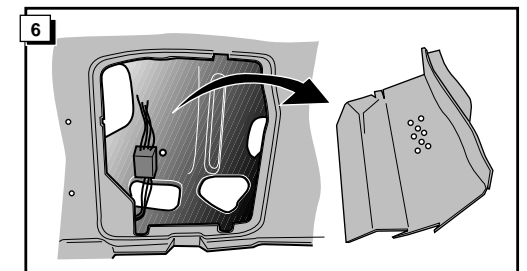
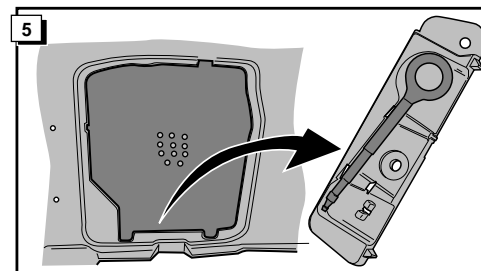
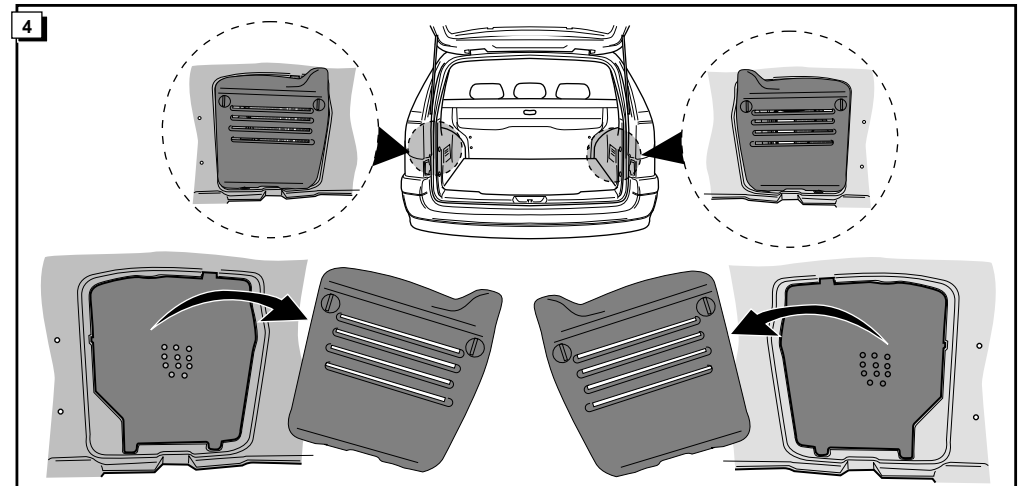
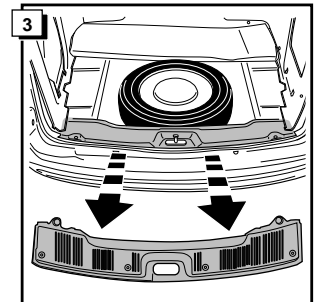
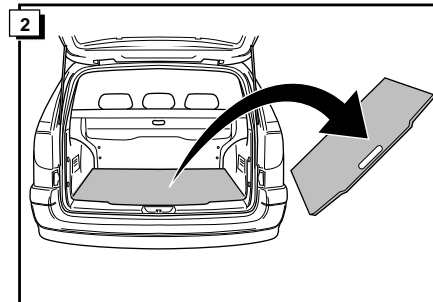
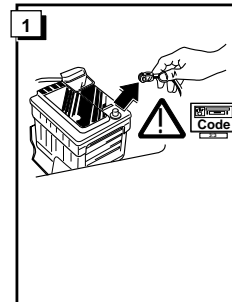
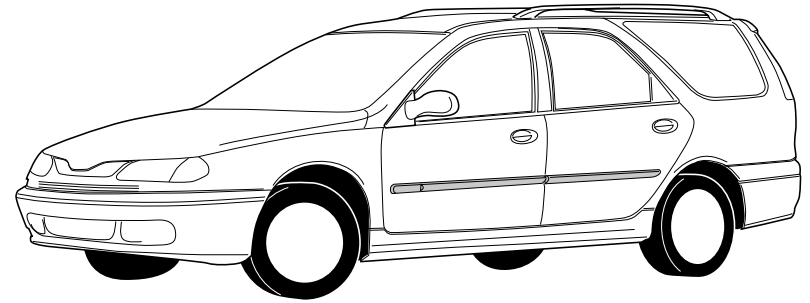

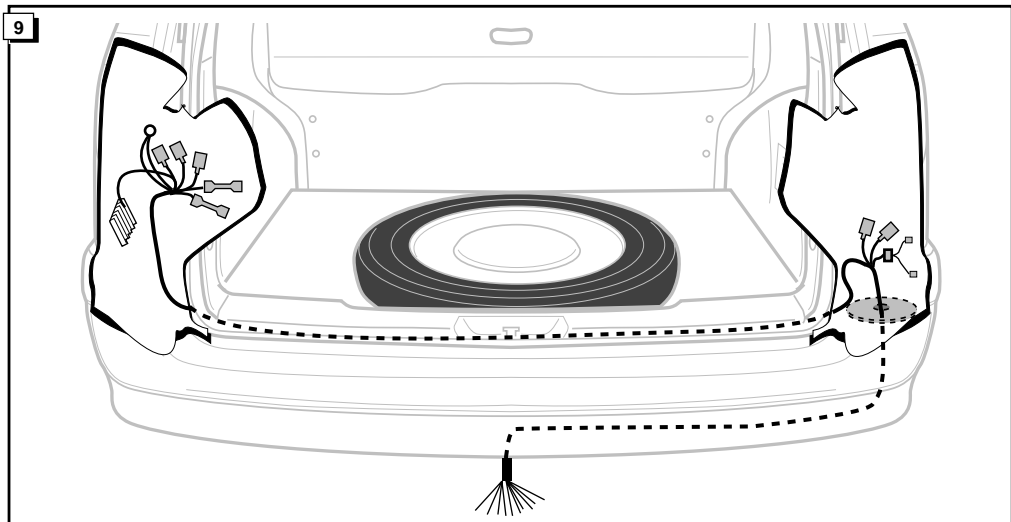
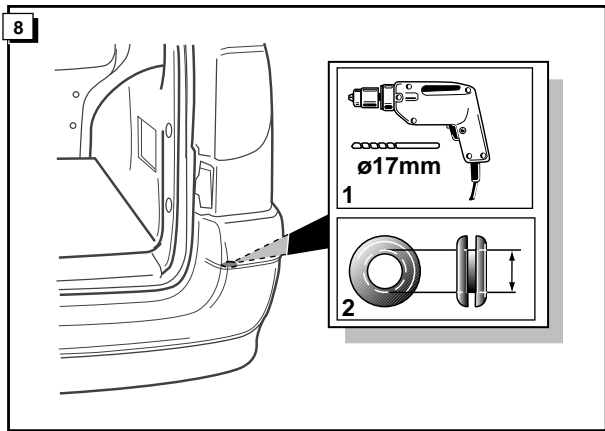
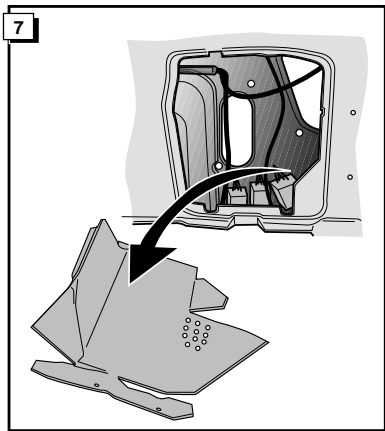

7 BLINKER LINKS
CLIGNOTANT GAUCHE
L.H. INDICATOR
KNIPPERLICHT LINKS

8 RUCKFAHR LEUCHE
PHARE DE RECVL.
REVERSE LIGHT
ACHTERUITRIJ-LICHT

9 SCHLÜSSELLEUCHE LINKS
FEU ARRIERE GAUCHE
L.H. REARLIGHT
ACHTERLICHT LINKS

10 BREMSLEUCHE
FEUX DE STOP
BRAKELICHTS
REMILICHTEN

11 BLINKER RECHTS
CLIGNOTANT DROIT
R.H. INDICATOR
KNIPPERLICHT RECHTS

12 SCHLÜSSELLEUCHE RECHTS
FEU ARRIERE DROIT
R.H. REARLIGHT
ACHTERLICHT RECHTS

13 MASSE
MASSE
EARTH
MASSA

	D	F	GB	NL
1/L	GELB	JAUNE	YELLOW	GEEL
2	BLAU	BLEU	BLUE	BLAUW
2a	GRAU	GRIS	GREY	GRIJS
3/31	WEIß	BLANC	WHITE	WIT
4/R	GRÜN	VERT	GREEN	GROEN
5/58-R	BRAUN	MARRON	BROWN	BRUIN
6/54	ROT	ROUGE	RED	ROOD
7/58-L	SCHWARZ	NOIR	BLACK	ZWART
8	SCHW/RT	NO/RO	BL/RD	ZW/RD
9	BR/WE	MAR/BLA	BR/WHI	BR/WI
10				
11				
12				
13	WEIß	BLANC	WHITE	WIT

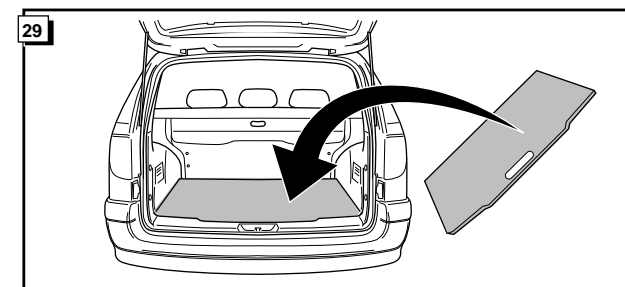
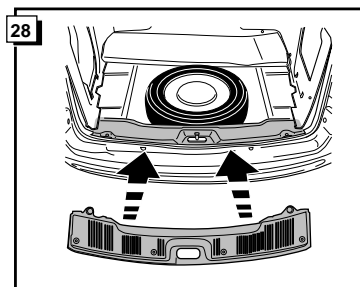
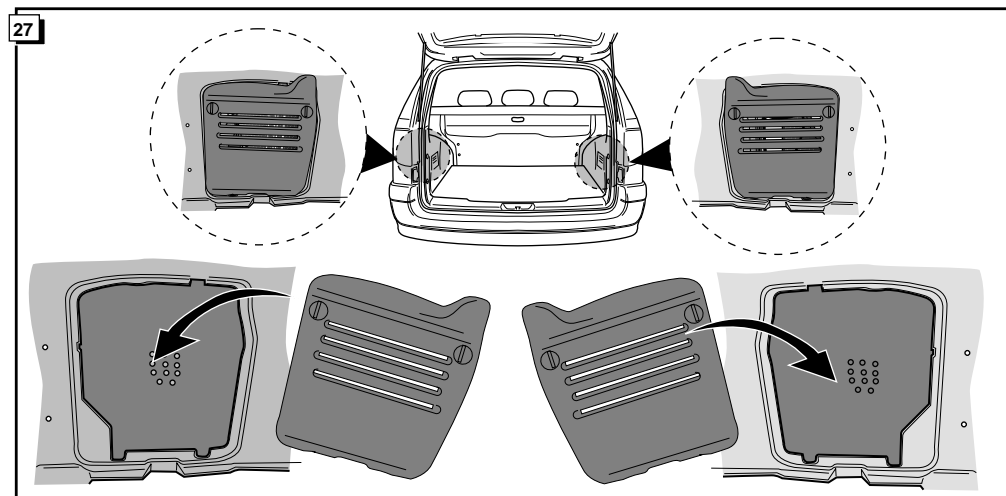
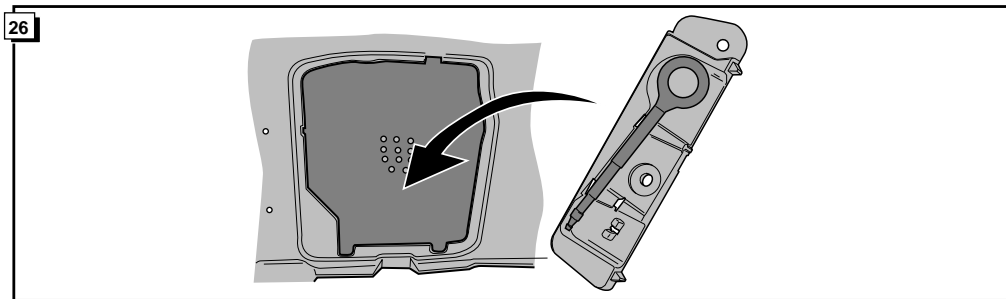
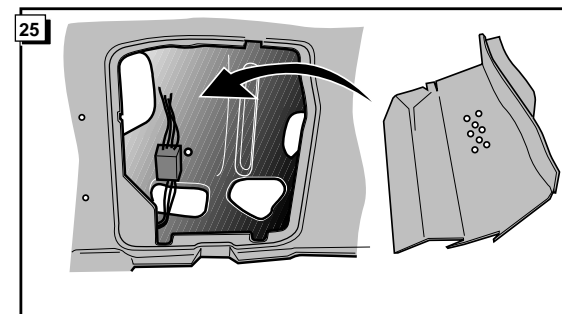
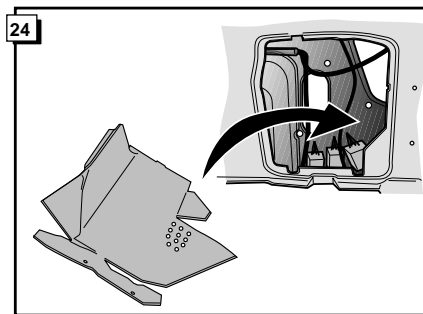

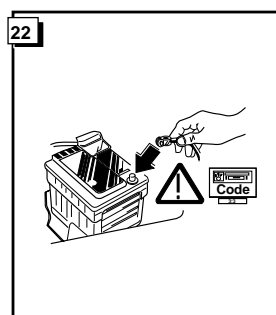
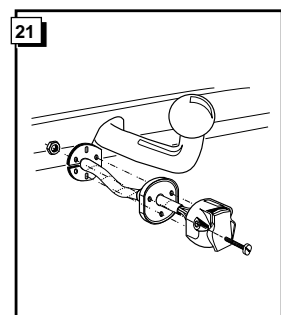
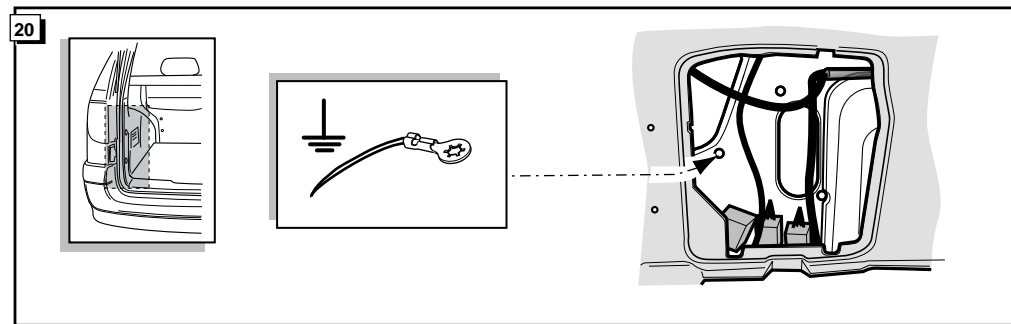
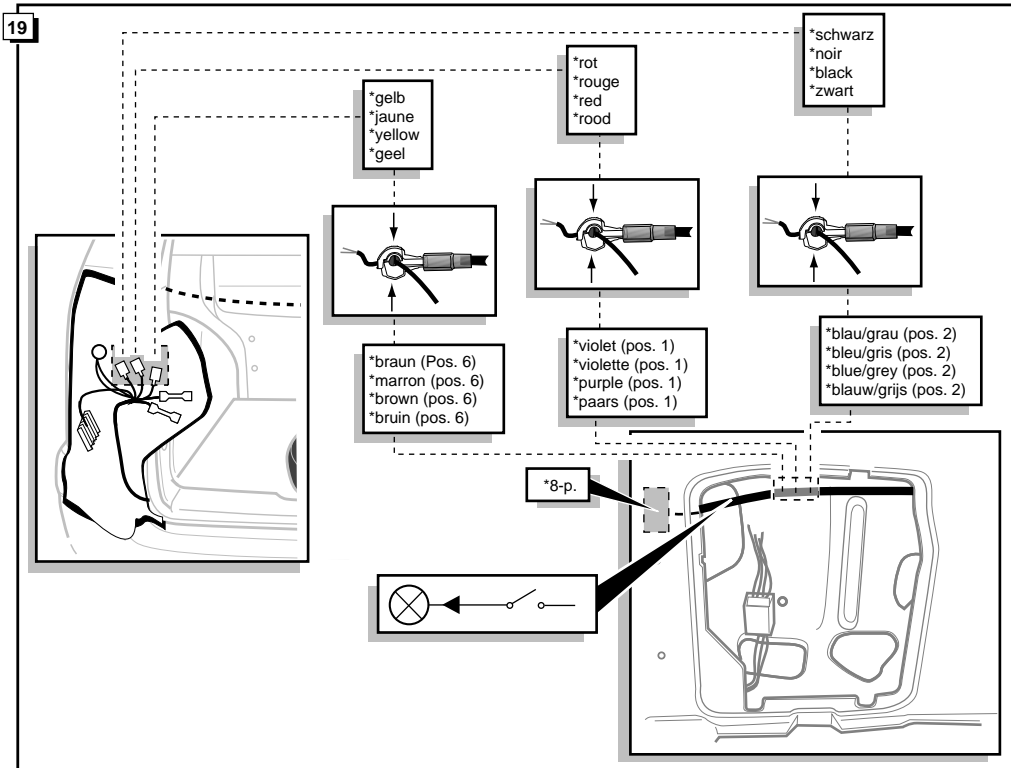

23

! FUNKTIONEN KONTROLIEREN !
! CONTRÔLER LES FONCTIONS !
! CHECK FUNCTIONS !
! CONTROLEER FUNKTIES !

